

RESERVATION MAÇONNERIE

MENUISERIE PVC PRIMIMUM

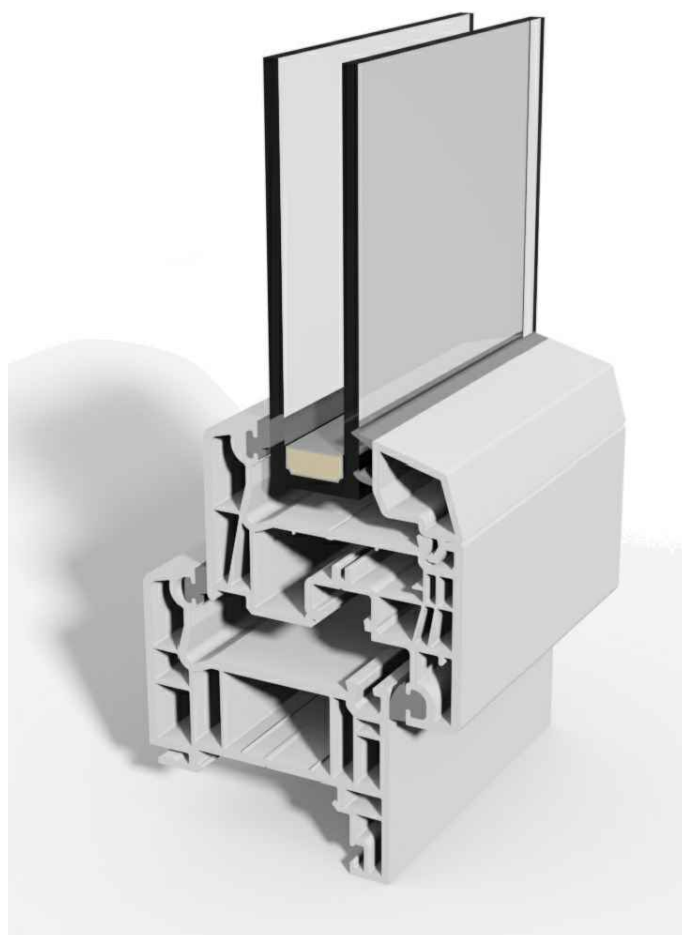



PLANS DE RESERVATIONS MAÇONNERIE des MENUISERIES à FRAPPE GAMME PVC Primum

FENETRES - PORTE FENÊTRE

TYPE DE POSE	TYPE D'APPUI	VOLET ROULANT				
		SANS	FOURNI	TRADI	PREFA	OPTIBAIE
1D 60	SUR ALLEGE	10001				
	SUR SOL FINI	10016				
	SEUIL COMPATIBLE PMR	10046				
	SI SEUIL ELARGI, REALISER APPUI SELON PLAN 10076					
1D 100	SUR ALLEGE	10181		10186	10191	
	SUR SOL FINI	10196		10201	10206	
	SEUIL COMPATIBLE PMR	10226	10221	10231	10236	
	SI SEUIL ELARGI, REALISER APPUI SELON PLAN 10256					
1D 120	SUR ALLEGE	10271		10276	10281	
	SUR SOL FINI	10286		10291	10296	
	SEUIL COMPATIBLE PMR	10316	10311	10321	10326	
	SI SEUIL ELARGI, REALISER APPUI SELON PLAN 10346					
1D 140	SUR ALLEGE	10361		10366	10371	
	SUR SOL FINI	10376		10381	10386	
	SEUIL COMPATIBLE PMR	10406	10401	10411	10416	
	SI SEUIL ELARGI, REALISER APPUI SELON PLAN 10436					

TYPE DE POSE	TYPE D'APPUI	VOLET ROULANT				
		SANS	FOURNI	TRADI	PREFA	OPTIBAIE
1D 160	SUR ALLEGE	10451			10456	10461
	SUR SOL FINI	10466			10471	10476
	SEUIL COMPATIBLE PMR	10496	10491	10501	10506	

TYPE DE POSE	TYPE D'APPUI	SANS	FOURNI	OPTION SELAR	OPTION SANS SELAR
		1 CSR	SUR ALLEGE	12001	12006
	SUR SOL FINI	12016	12021		12076
	SEUIL COMPATIBLE PMR	12046	12051		
1 C	SUR ALLEGE	12096	12101		
	SUR SOL FINI	12111	12116		
	SEUIL COMPATIBLE PMR	12141	12146		
2 CT	SUR ALLEGE	12181	12186		12241
	SUR SOL FINI	12196	12201		12256
	SEUIL COMPATIBLE PMR	12226	12231		
2 CA	SUR ALLEGE	12271	12276		
	SUR SOL FINI	12286	12291		
	SEUIL COMPATIBLE PMR	12316	12321		

 	SOMMAIRE	
	Fichier : ResaCAIB_Pvc_P1.xlsx	
	Des : D.MARCOLINI	Ech :
	Date : 01/09/2016	N° :

GLOSSAIRE DES TYPES DE POSE :

- 1D60 à 1D160 -> POSE EN APPLIQUE (NEUF) AVEC ISOLATION INTERIEURE (DOUBLAGE)
- 1CSR -> POSE EN FEUILLURE CIMENT SANS RECOUVREMENT
- 1C -> POSE EN FEUILLURE CIMENT (AVEC RECOUVREMENT)
- 2CA -> POSE EN TUNNEL CIMENT (AVEC RECOUVREMENT)
- 2CT -> POSE EN PLEIN TUNNEL CIMENT (SANS RECOUVREMENT)

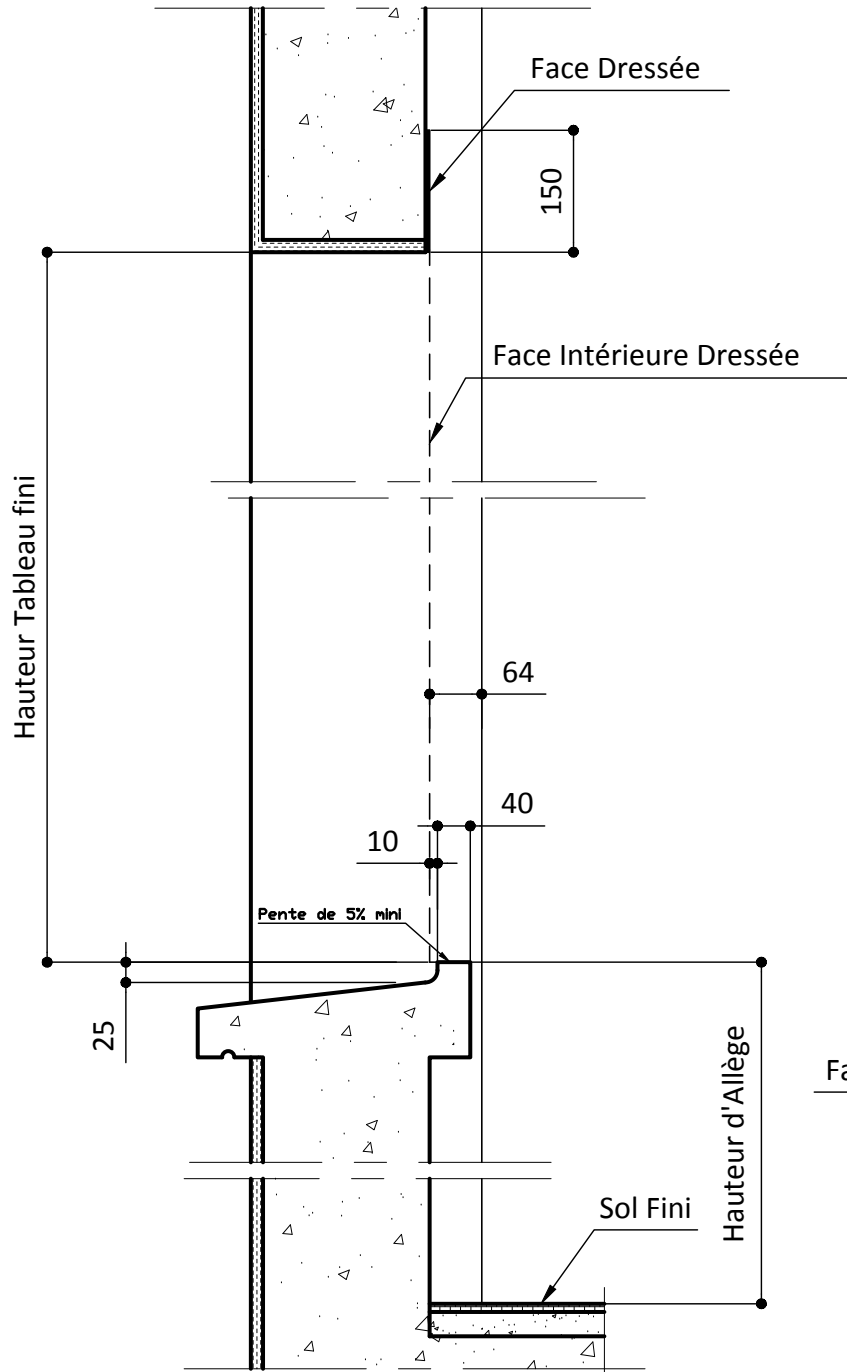

REPÈRE	TABLEAU FINI		SENS D'OUVERTURE	VITRAGE EXT / INT	OBSERVATIONS	QTE
	HAUTEUR	LARGEUR				

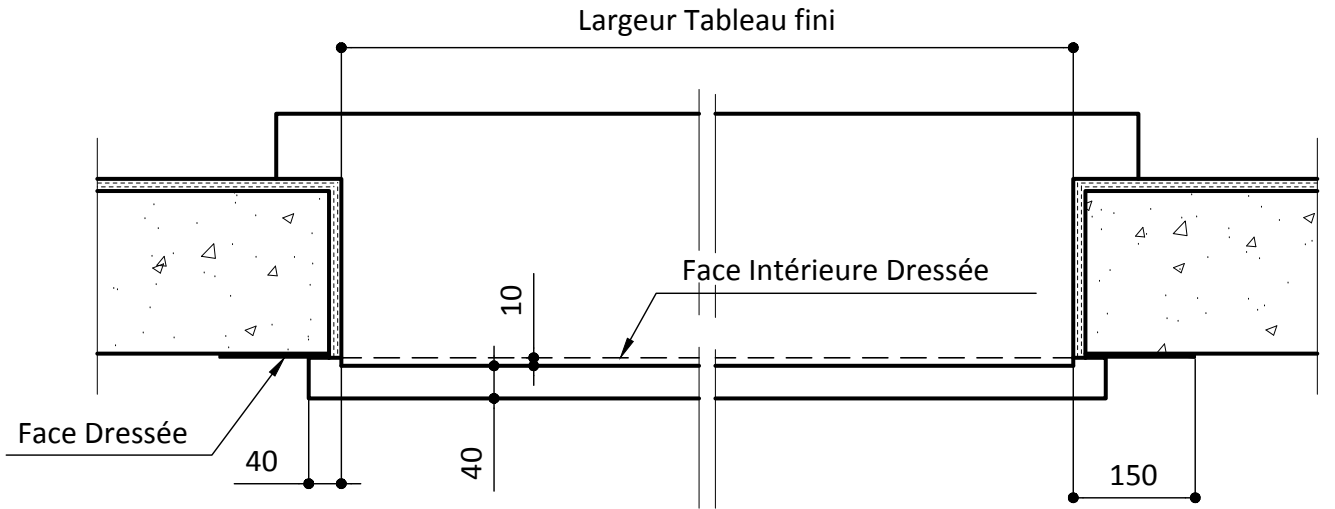

Désignation du plan :
 FRAPPE SUR ALLEGE - POSE APPLIQUE
 DE 60mm (1D60) - SANS VR

Fichier : ResaCAIB_Pvc_P1.dwg

Des. : M.CHAUVIERE Ech : 1 / 10 T5

Date : 09/01/2018 N° : 10001

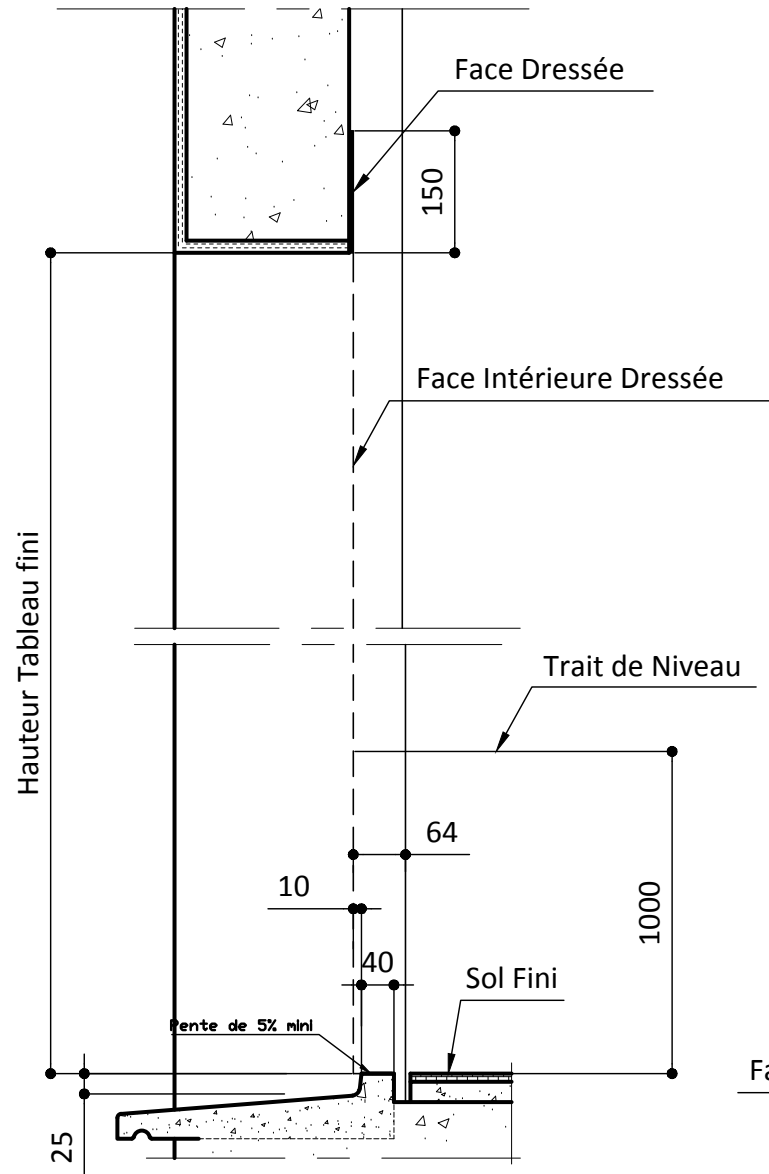

SEUIL STANDARD

REPERE	TABLEAU FINI		SENS D'OUVERTURE	VITRAGE EXT / INT	OBSERVATIONS	QTE
	HAUTEUR	LARGEUR				

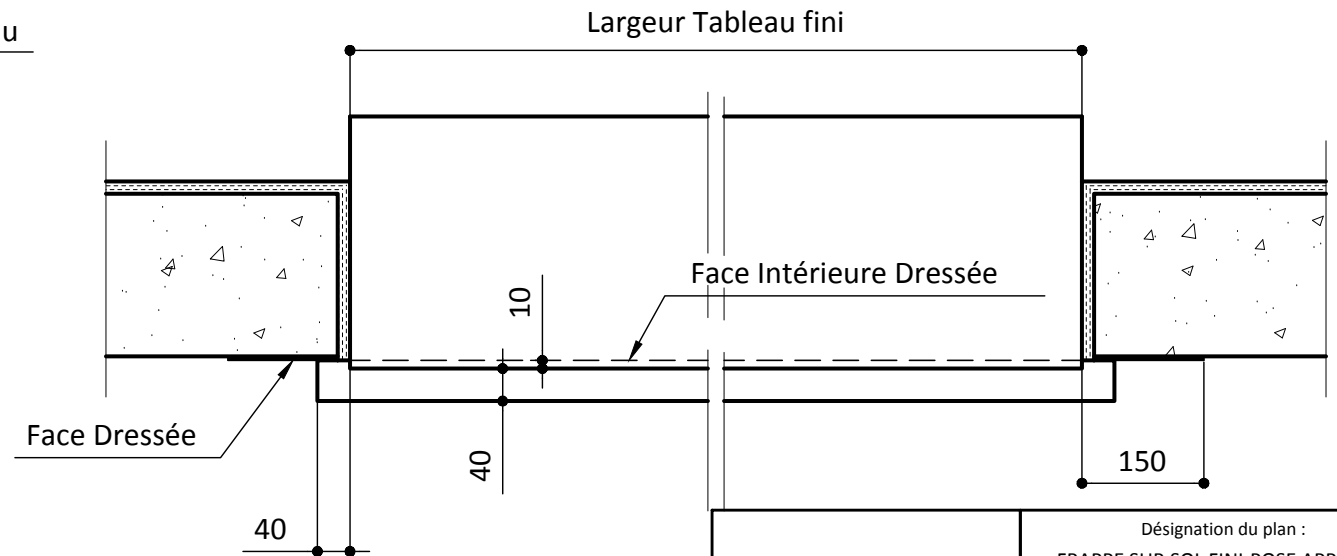

Désignation du plan :
 FRAPPE SUR SOL FINI-POSE APPLIQUE
 DE 60mm (1D60) - SANS VR

Fichier : ResaCAIB_Pvc_P1.dwg

Des. : M.CHAUVIERE Ech : 1 / 10 W5

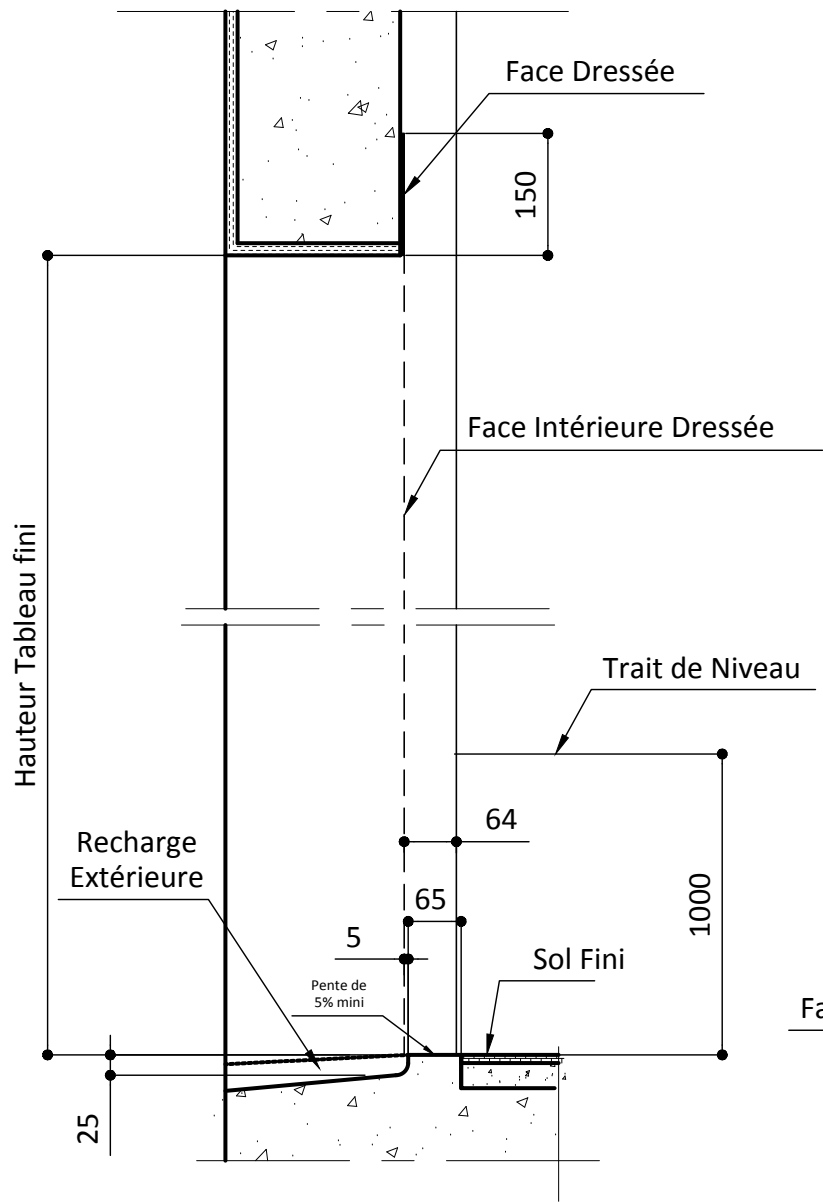

Date : 09/01/2018 N° : 10016

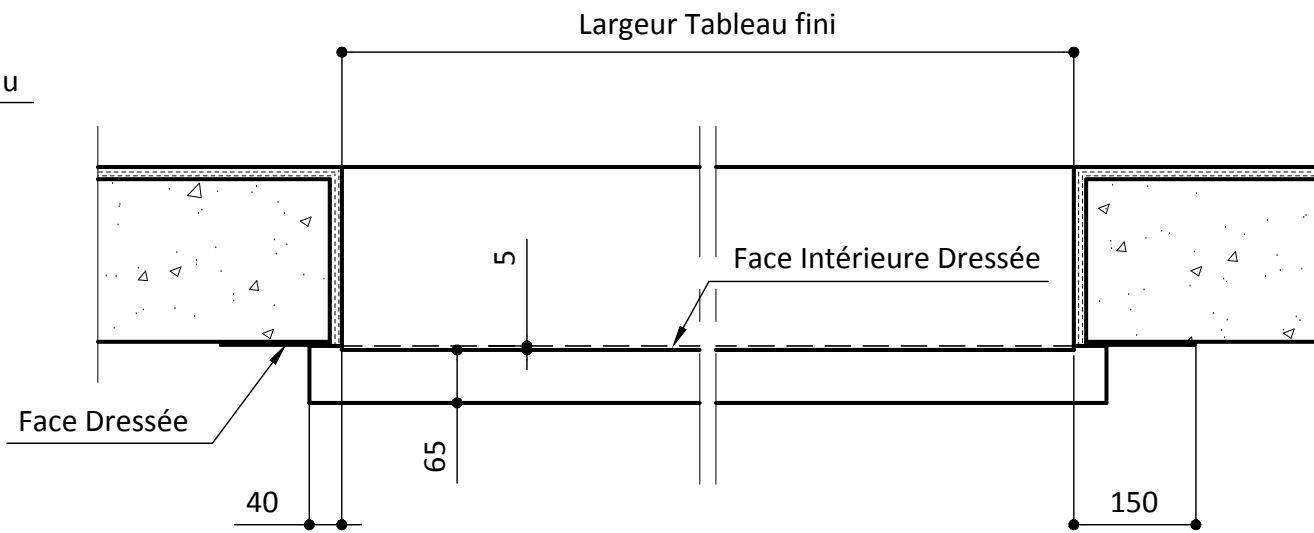

SEUIL PMR

REPÈRE	TABLEAU FINI		SENS D'OUVERTURE	VITRAGE EXT / INT	OBSERVATIONS	QTE
	HAUTEUR	LARGEUR				



Désignation du plan :
FRAPPE SEUIL PMR - POSE APPLIQUE
DE 60mm (1D60) - SANS VR

Fichier : ResaCAIB_Pvc_P1.dwg

Des. : M.CHAUVIERE Ech : 1 / 10 CC5

Date : 09/01/2018 N° : 10046

RESERVATIONS MAÇONNERIE
SI SEUILS ELARGIS en DOUBLAGE de 60mm

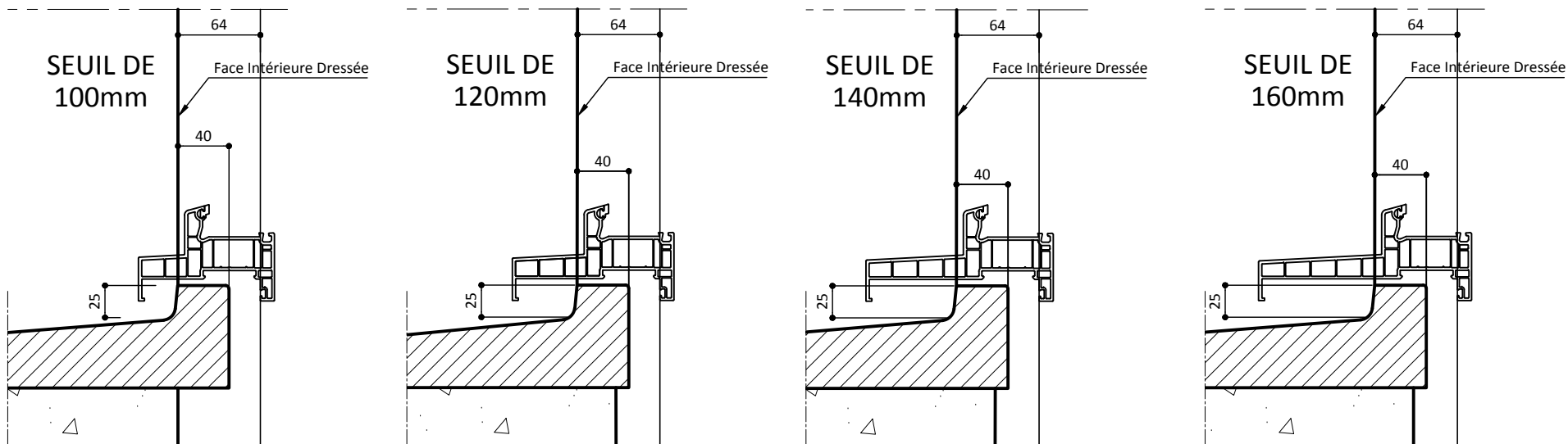

POSITIONNER L'APPUI MAÇONNERIE EN FONCTION DU SEUIL CHOISI

SUR ALLEGE MAÇONNERIE



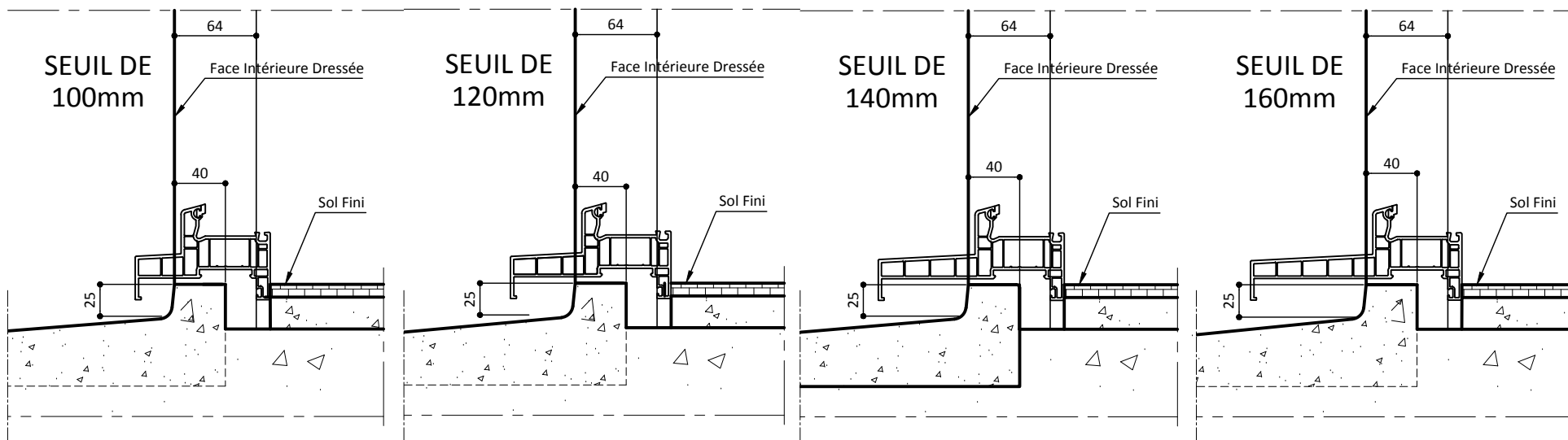

SUR SOL FINI

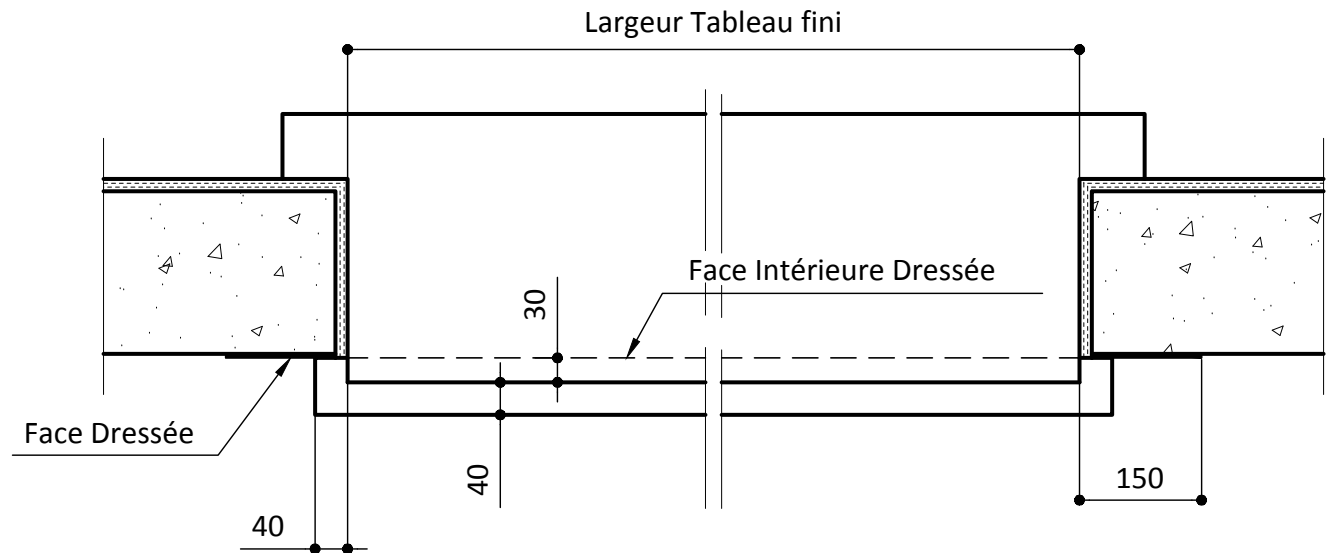
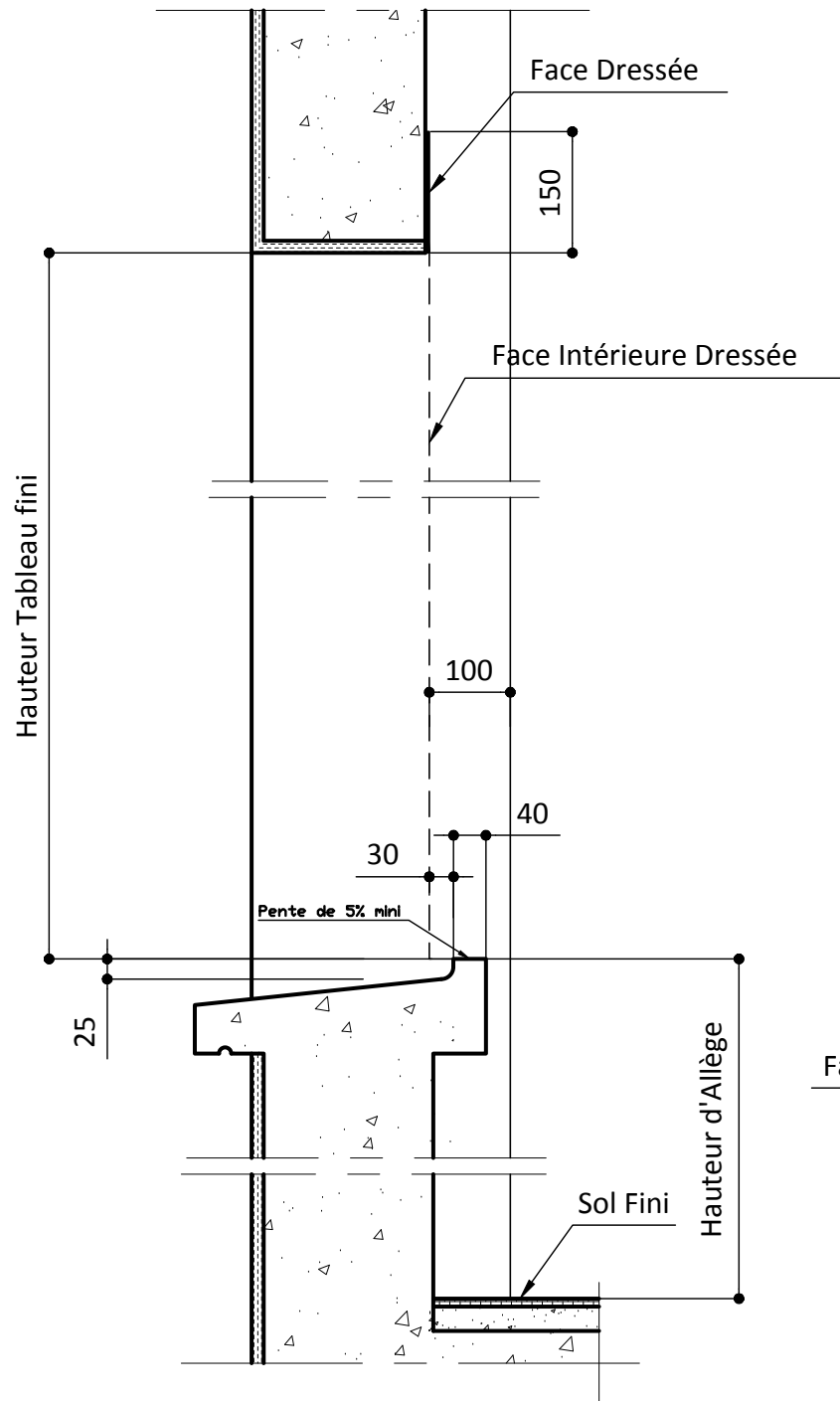

 	Désignation du plan : FRAPPE SEUIL ELARGI - POSE 1D60 SUR ALLEGE ET SOL FINI	
	Fichier : ResaCAIB_Pvc_P1.dwg	
	Des. : M.CHAUVIERE	Ech : 1 / 5 IIS
	Date : 09/01/2018	N° : 10076



REPÈRE	TABLEAU FINI		SENS D'OUVERTURE	VITRAGE EXT / INT	OBSERVATIONS	QTE
	HAUTEUR	LARGEUR				

 	Désignation du plan : FRAPPE SUR ALLEGE - POSE 1D100 SANS VR - VR EVIBAIE - VR TRADITIONNEL		
	Fichier : ResaCAIB_Pvc_P1.dwg		
Des. : M.CHAUVIERE	Ech : 1 / 10	T7	
Date : 09/01/2018	N° : 10181		

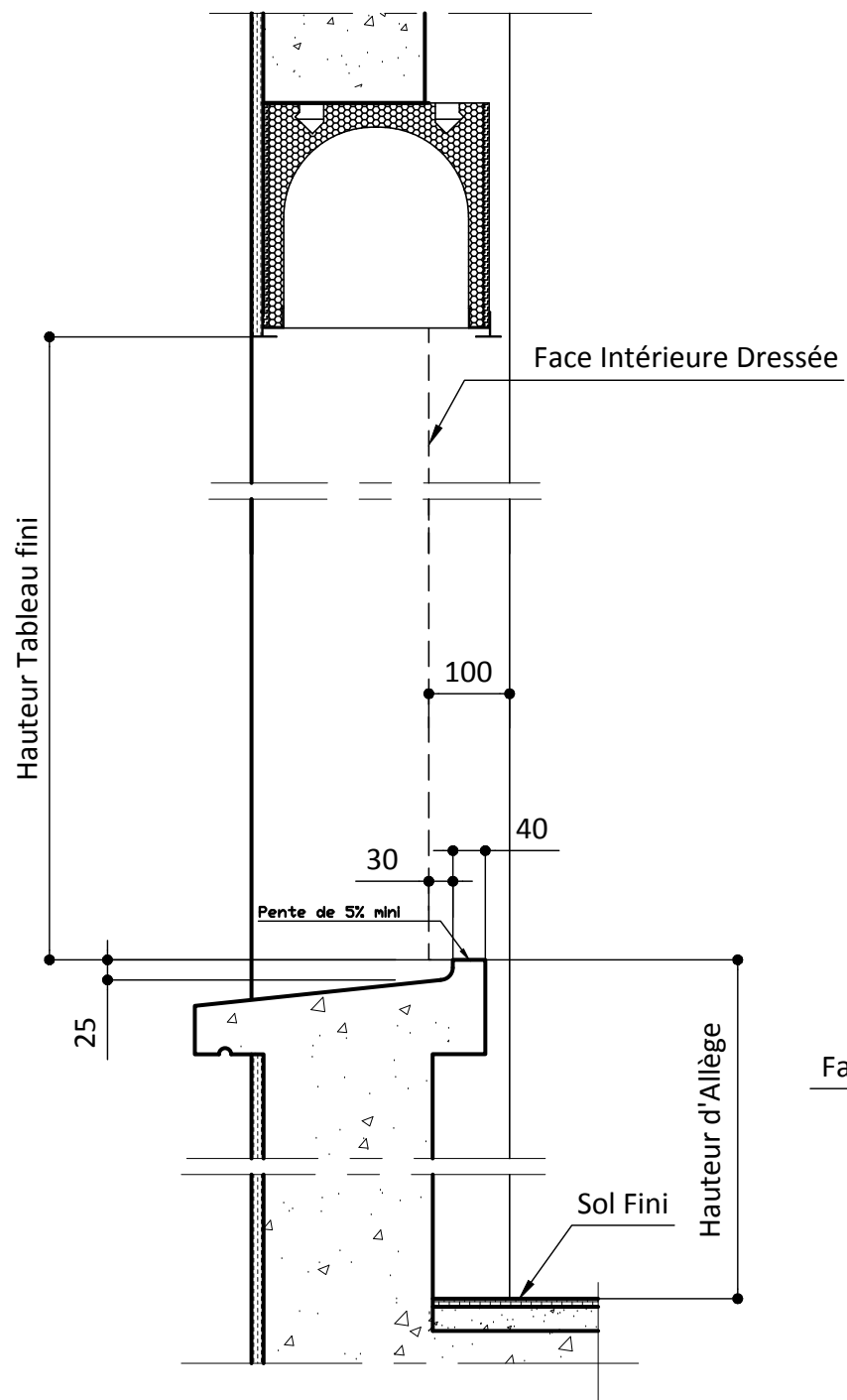

REPERE	TABLEAU FINI		SENS D'OUVERTURE	VITRAGE EXT / INT	OBSERVATIONS	QTE
	HAUTEUR	LARGEUR				

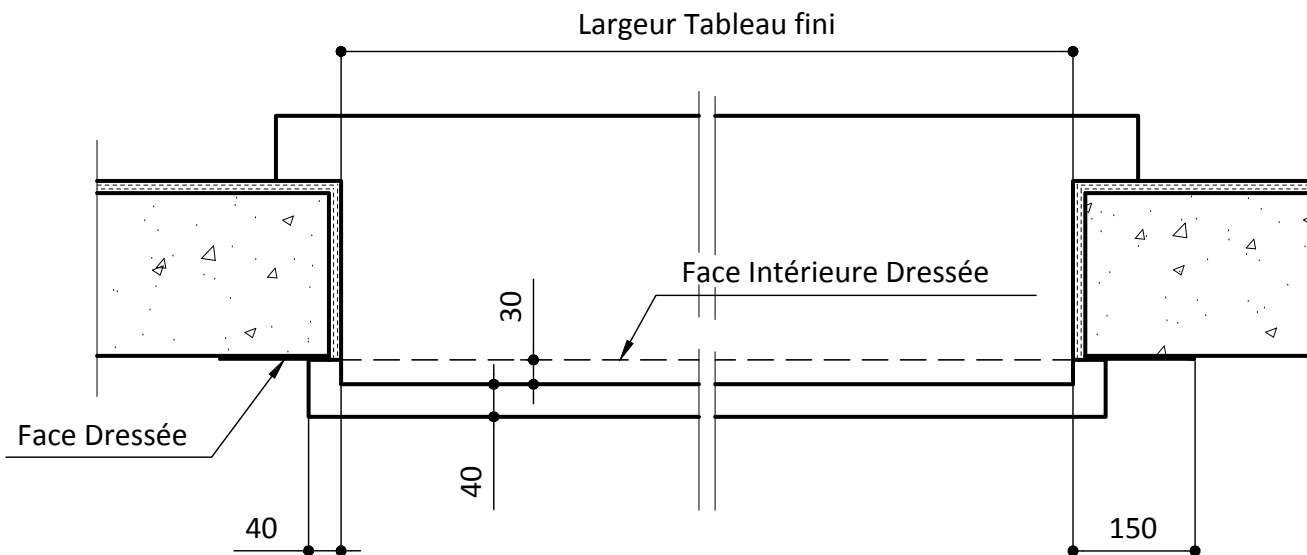

Désignation du plan :
 FRAPPE SUR ALLEGE - POSE 1D100
 VR PREFE (enroulement ext. et int.)

Fichier : ResaCAIB_Pvc_P1.dwg

Des. : M.CHAUVIERE Ech : 1 / 10 U7

Date : 09/01/2018 N° : 10186

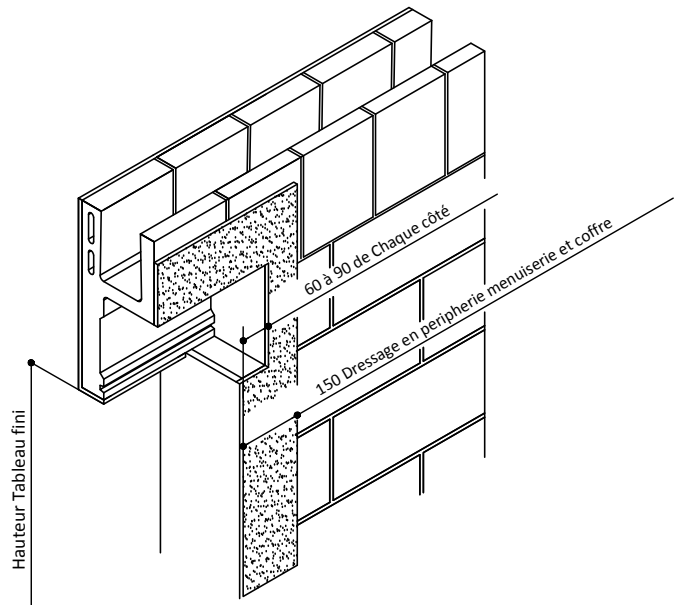
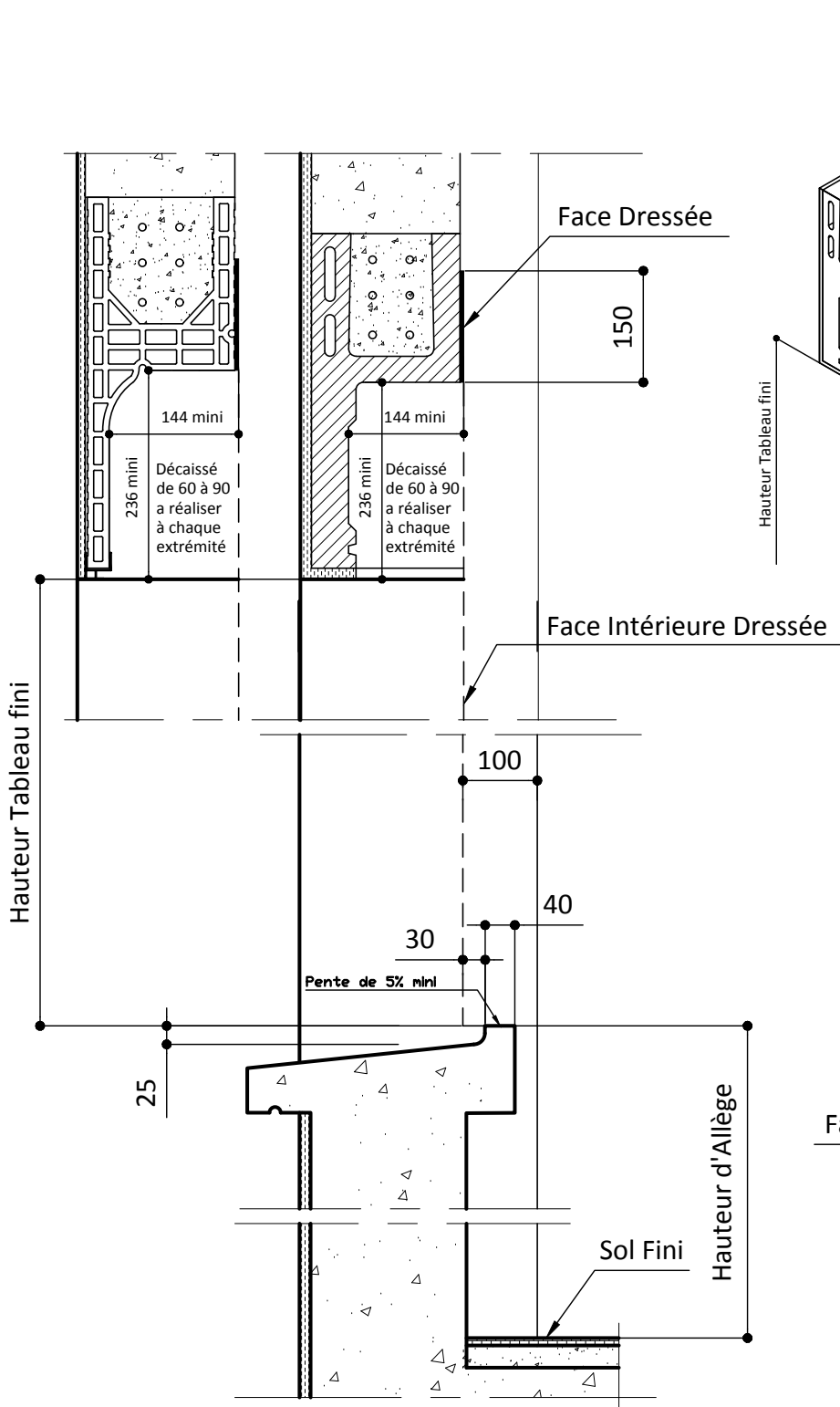



REPÈRE	TABLEAU FINI		SENS D'OUVERTURE	QTE
	HAUTEUR	LARGEUR		

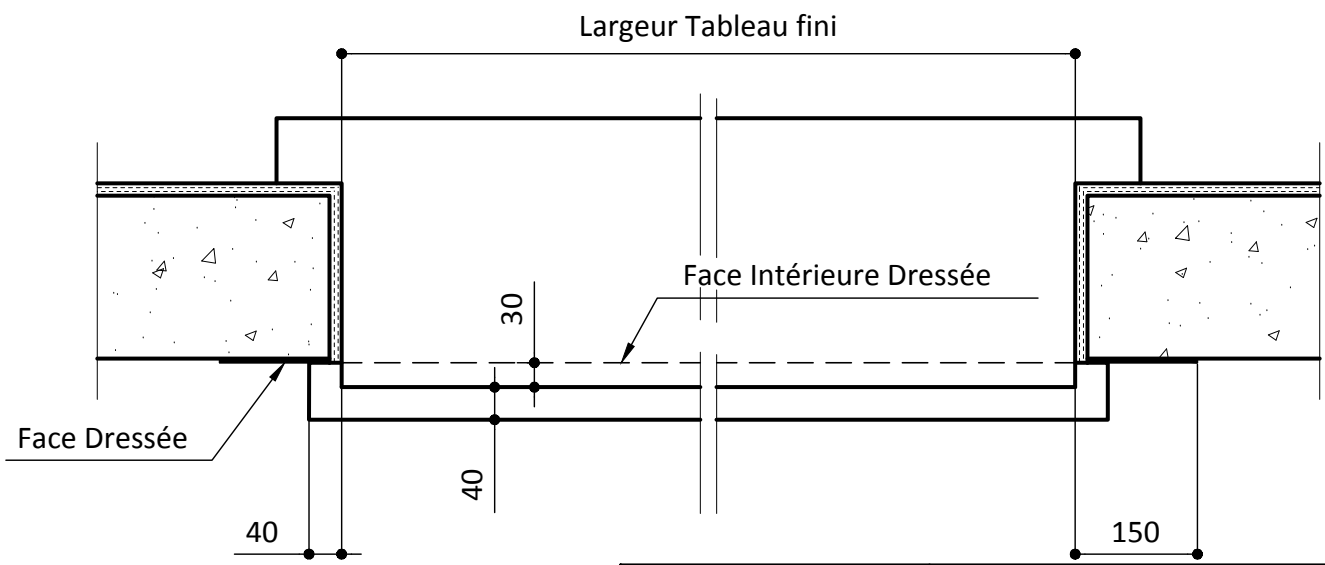

ATTENTION! UTILISER UN TYPE DE DEMI-COFFRE PRÉCONISÉ PAR NOTRE B.E



 	Désignation du plan : FRAPPE SUR ALLEGE - POSE 1D100 VR OPTIBAIE (pose dans demi-linteau)		
	Fichier : ResaCAIB_Pvc_P1.dwg		
	Des. : M.CHAUVIERE	Ech : 1 / 10	V7
	Date : 09/01/2018	N° :	10191

REPÈRE	TABLEAU FINI		SENS D'OUVERTURE	VITRAGE EXT / INT	OBSERVATIONS	QTE
	HAUTEUR	LARGEUR				

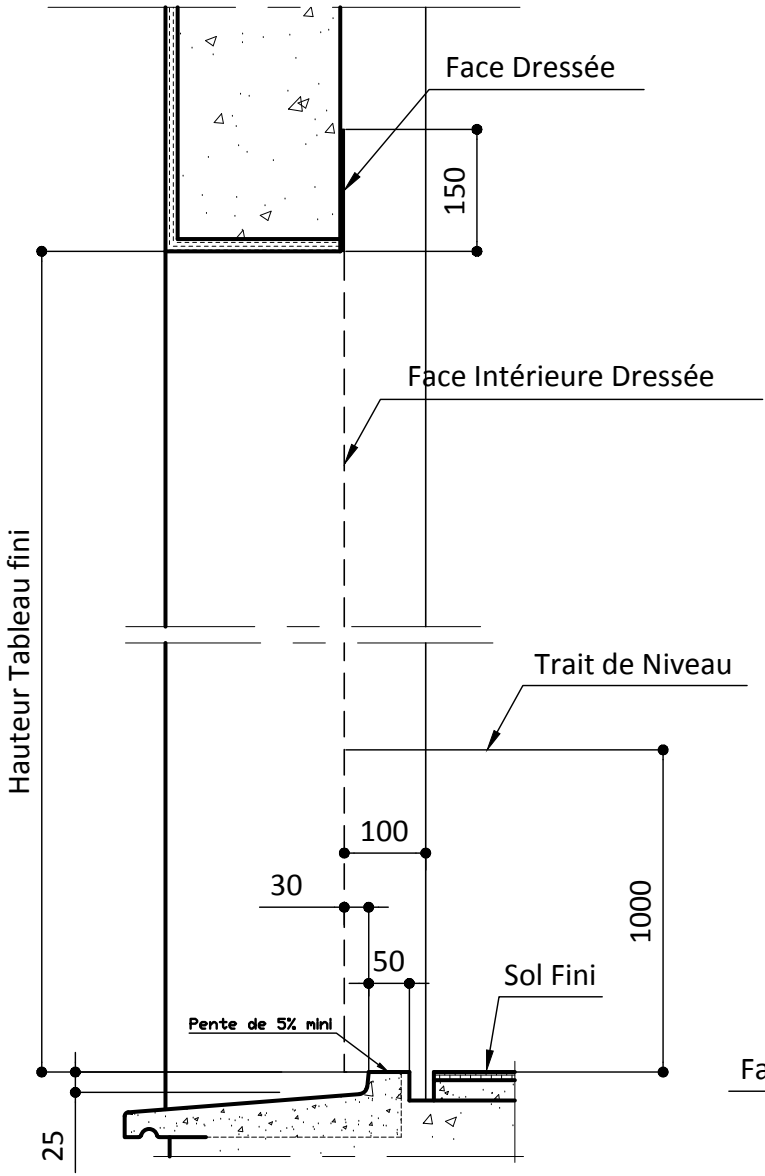

SEUIL STANDARD

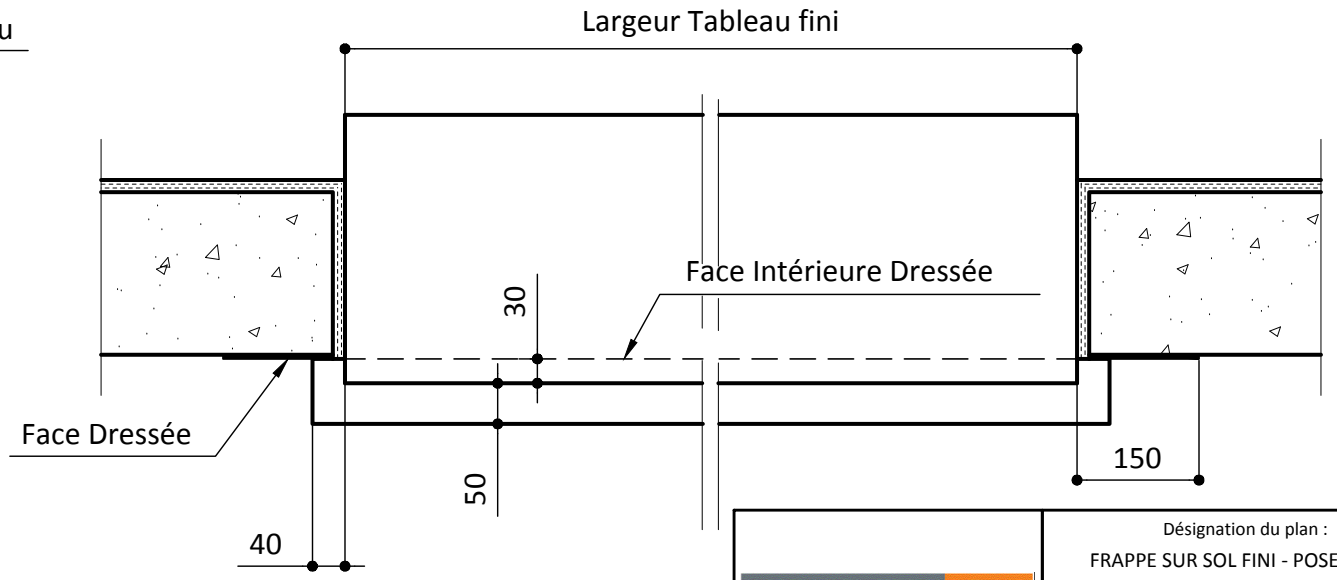

Désignation du plan :
 FRAPPE SUR SOL FINI - POSE 1D100
 SANS VR - VR EVIBAIE - VR TRADITIONNEL
 Fichier : ResaCAIB_Pvc_P1.dwg
 Des. : M.CHAUVIERE Ech : 1 / 10 W7
 Date : 09/01/2018 N° : 10196

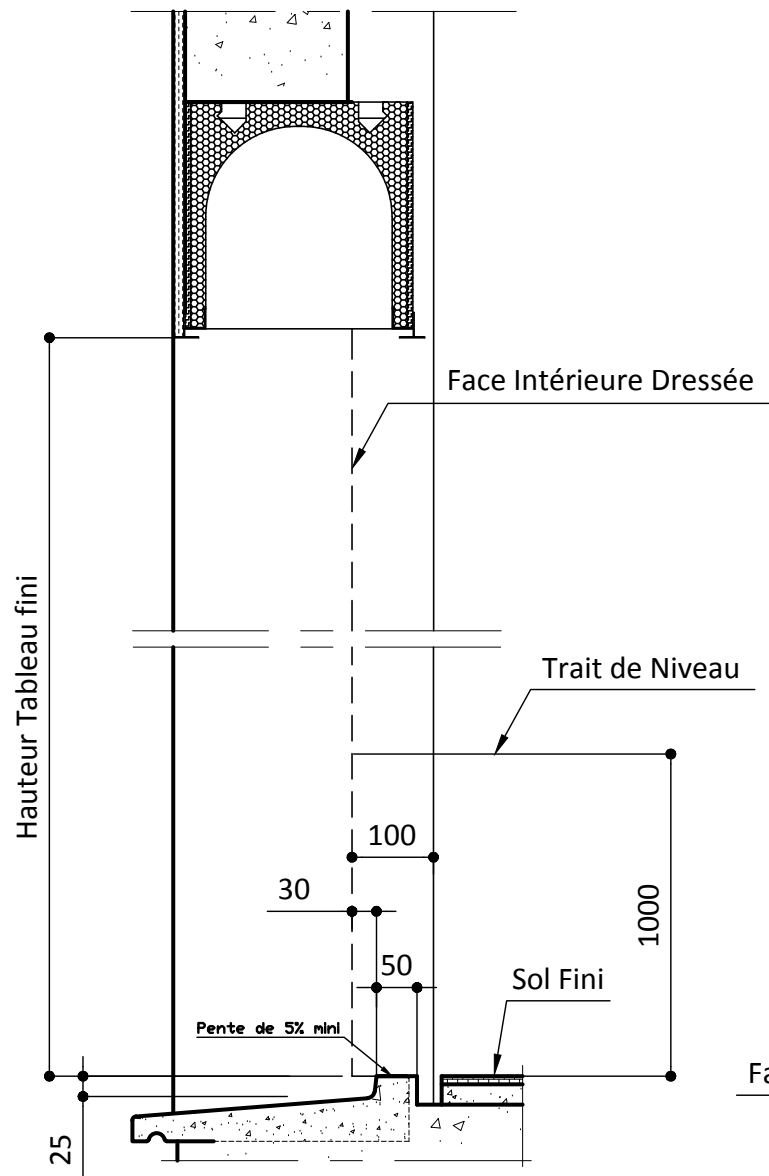

SEUIL STANDARD

REPERE	TABLEAU FINI		SENS D'OUVERTURE	VITRAGE EXT / INT	OBSERVATIONS	QTE
	HAUTEUR	LARGEUR				

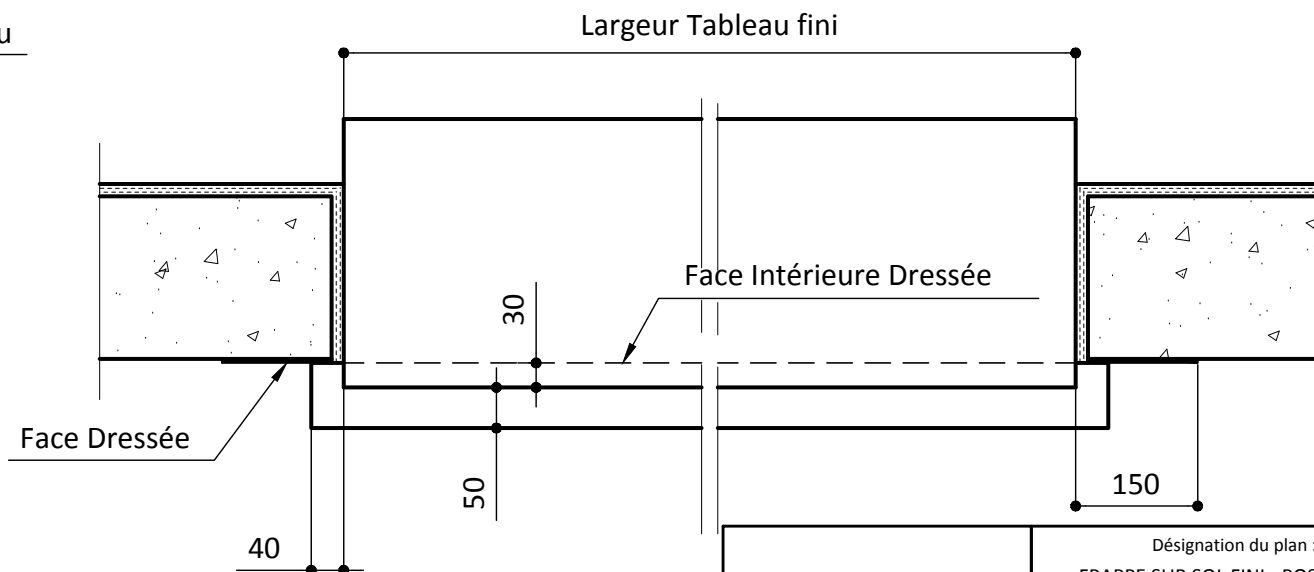

Désignation du plan :
 FRAPPE SUR SOL FINI - POSE 1D100
 VR PREFAB (enroulement ext. et int.)

Fichier : ResaCAIB_Pvc_P1.dwg

Des. : M.CHAUVIERE Ech : 1 / 10 X7

Date : 09/01/2018 N° : 10201

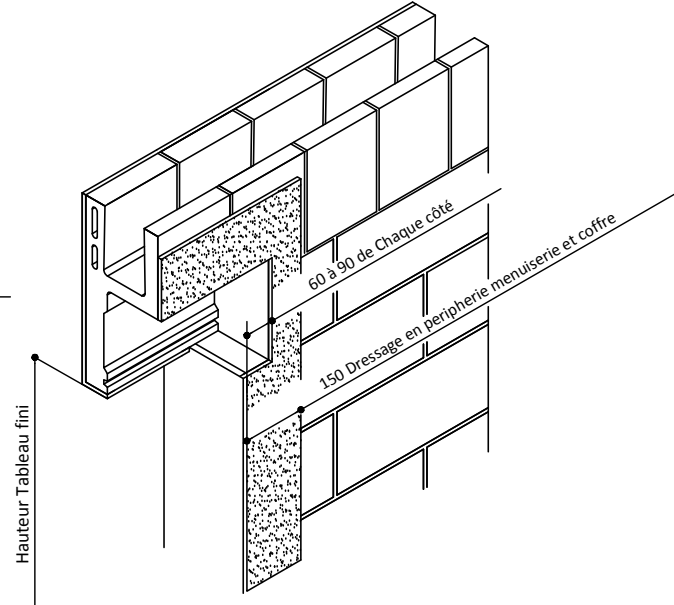
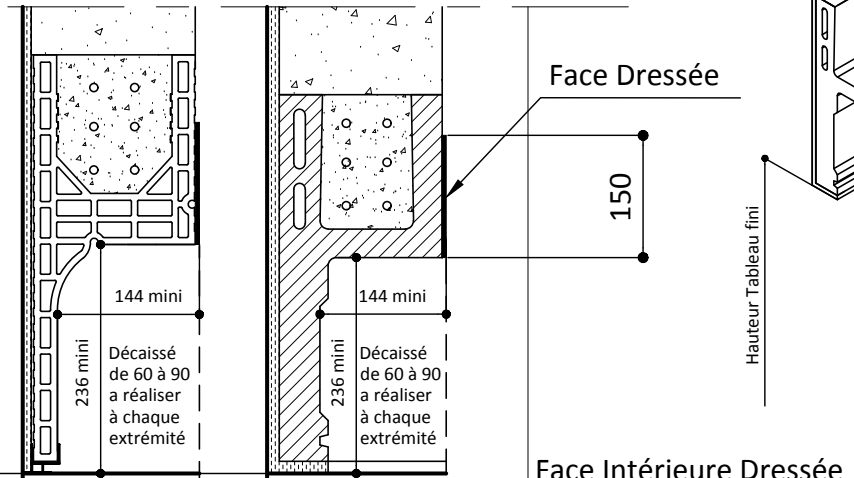

REPERE	TABLEAU FINI		SENS D'OUVERTURE	QTE
	HAUTEUR	LARGEUR		



ATTENTION! UTILISER UN TYPE DE DEMI-COFFRE PRÉCONISÉ PAR NOTRE B.E

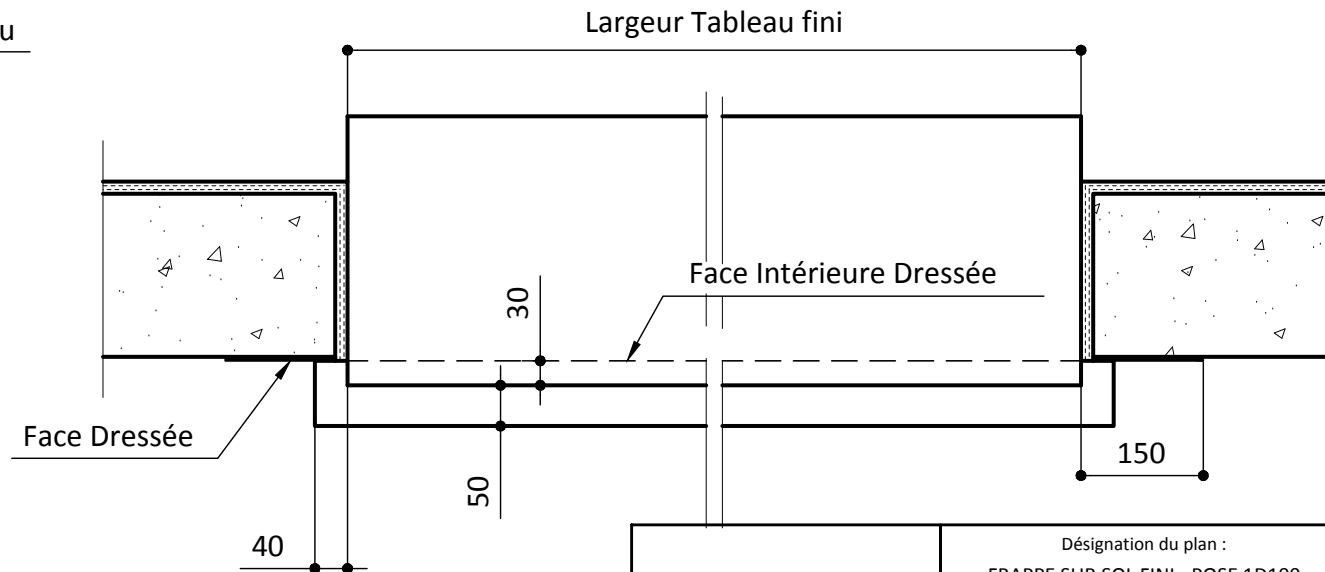
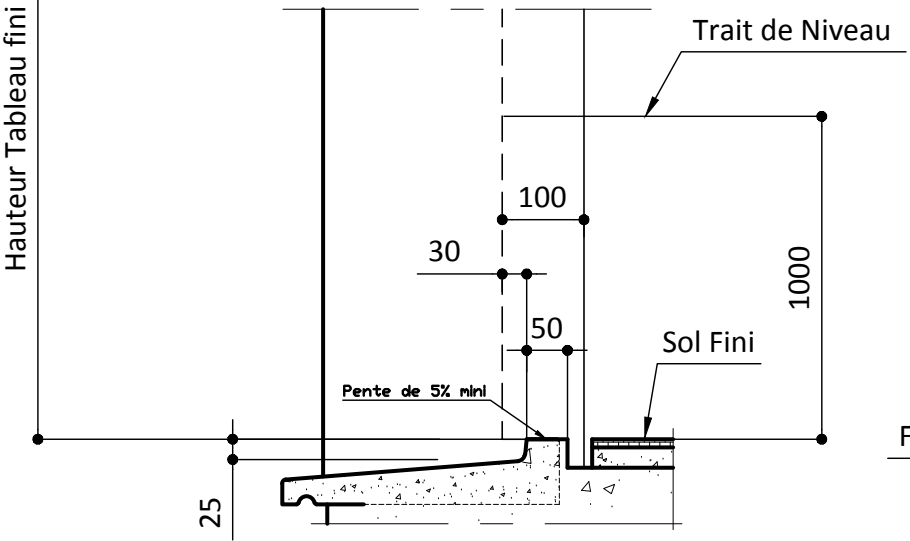

SEUIL STANDARD



Désignation du plan : FRAPPE SUR SOL FINI - POSE 1D100 VR OPTIBAIE (pose dans demi-linteau)		
Fichier : ResaCAIB_Pvc_P1.dwg		
Des. : M.CHAUVIERE	Ech : 1 / 10	Y7
Date : 09/01/2018	N° :	10206

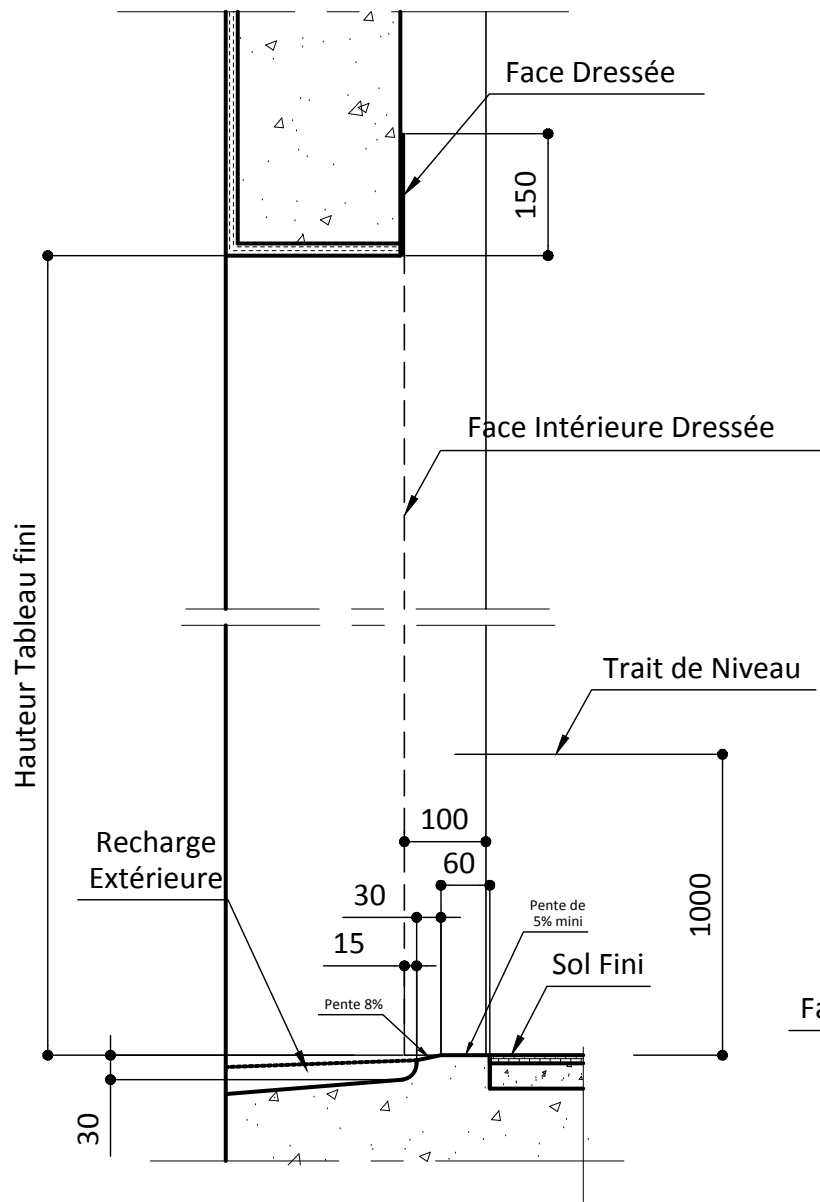

SEUIL PMR

REPÈRE	TABLEAU FINI		SENS D'OUVERTURE	VITRAGE EXT / INT	OBSERVATIONS	QTE
	HAUTEUR	LARGEUR				

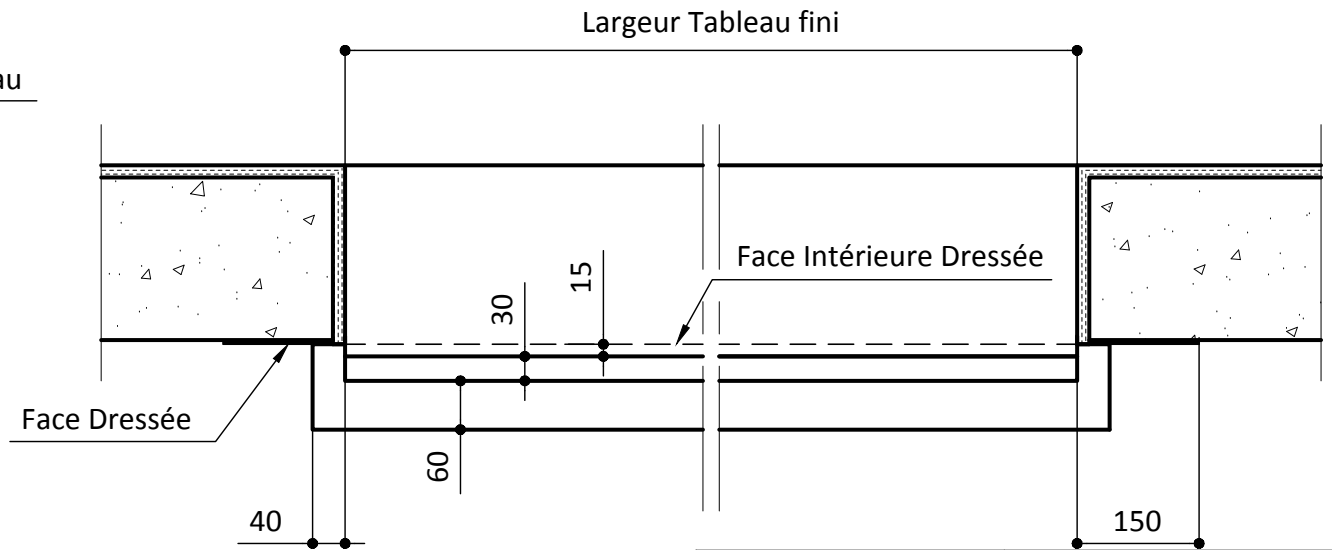

Désignation du plan :
 FRAPPE SEUIL PMR - POSE 1D100
 VR EVIBAIE - VR TRADITIONNEL

Fichier : ResaCAIB_Pvc_P1.dwg

Des. : M.CHAUVIERE Ech : 1 / 10 BB7

Date : 09/01/2018 N° : 10221

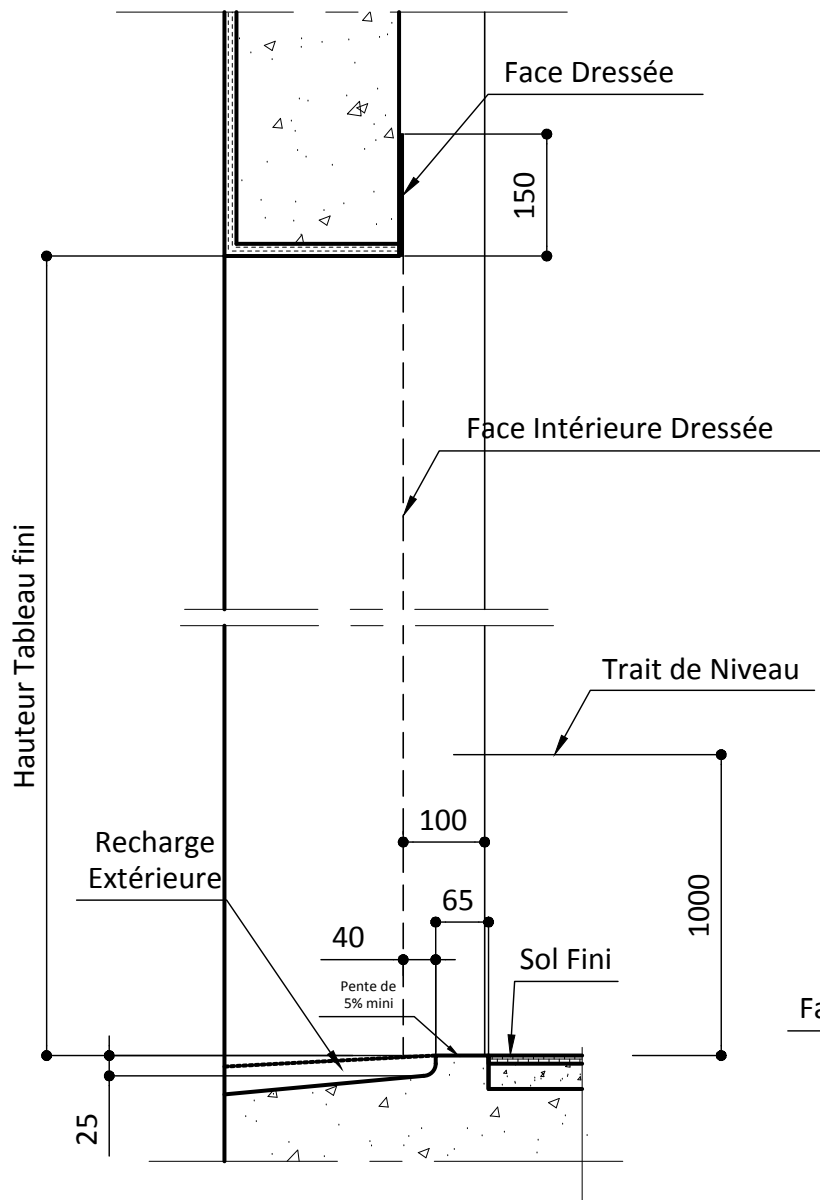

SEUIL PMR

REPÈRE	TABLEAU FINI		SENS D'OUVERTURE	VITRAGE EXT / INT	OBSERVATIONS	QTE
	HAUTEUR	LARGEUR				

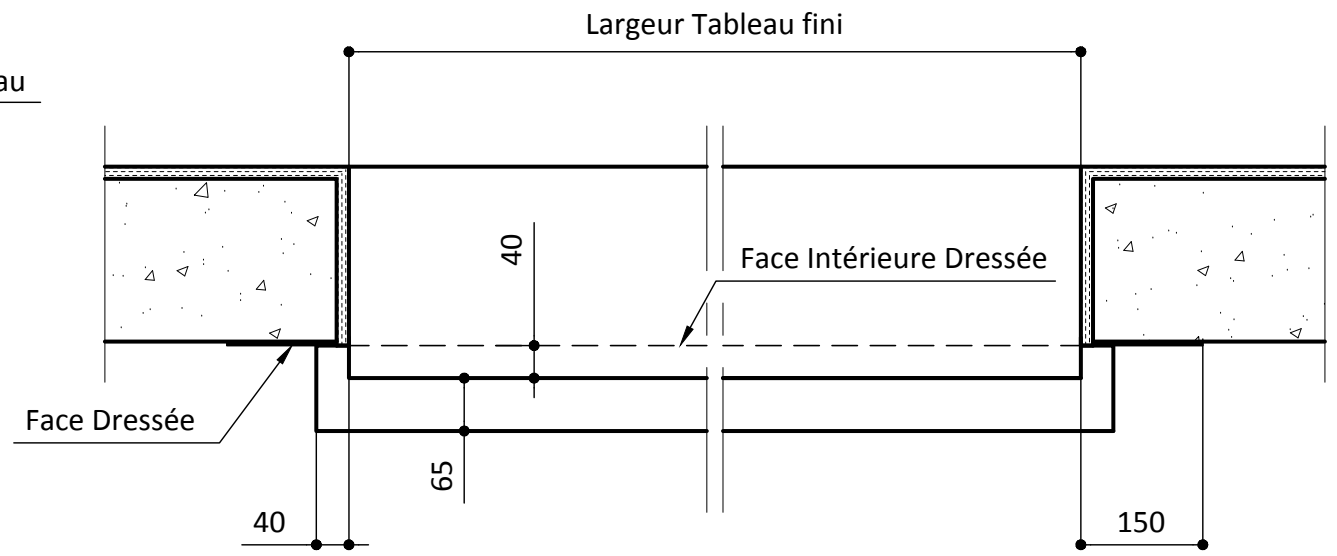

Désignation du plan :
FRAPPE SEUIL PMR - POSE 1D100
SANS VR

Fichier : ResaCAIB_Pvc_P1.dwg

Des. : M.CHAUVIERE Ech : 1 / 10 CC7

Date : 09/01/2018 N° : 10226

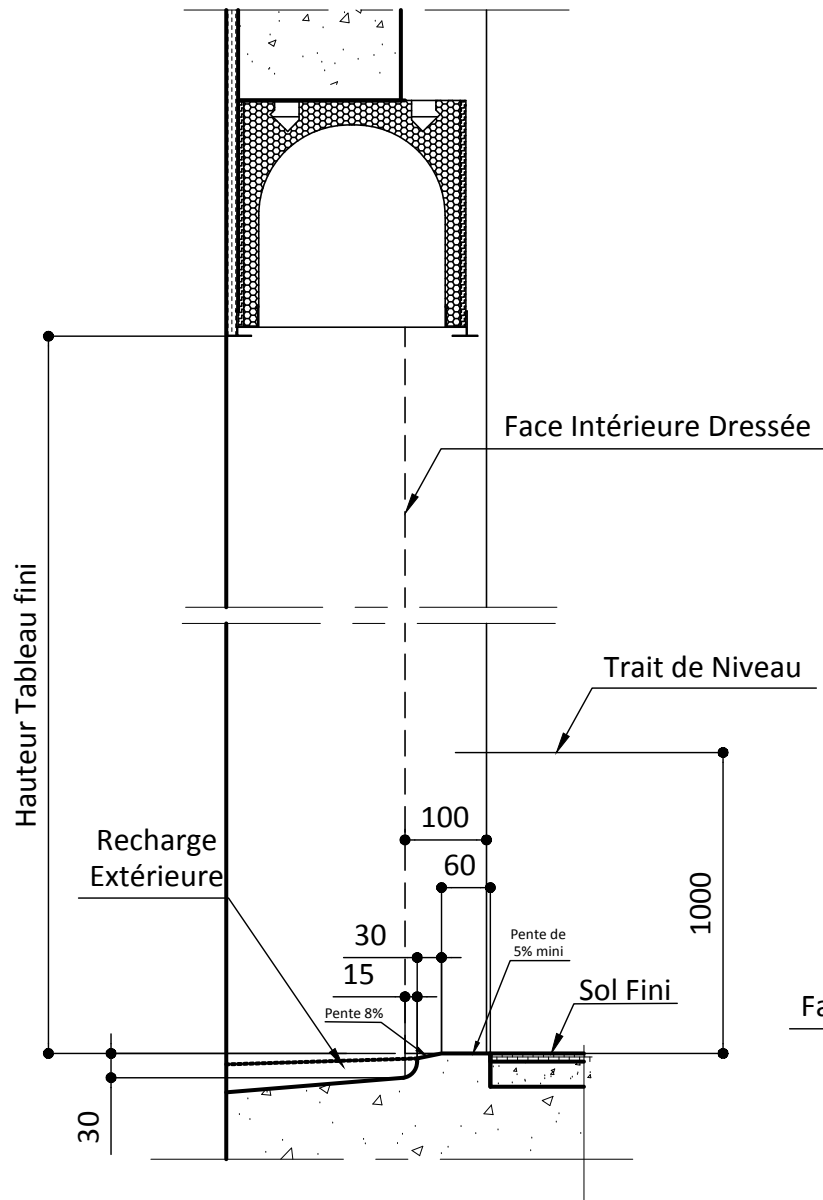

SEUIL PMR

REPERE	TABLEAU FINI		SENS D'OUVERTURE	VITRAGE EXT / INT	OBSERVATIONS	QTE
	HAUTEUR	LARGEUR				

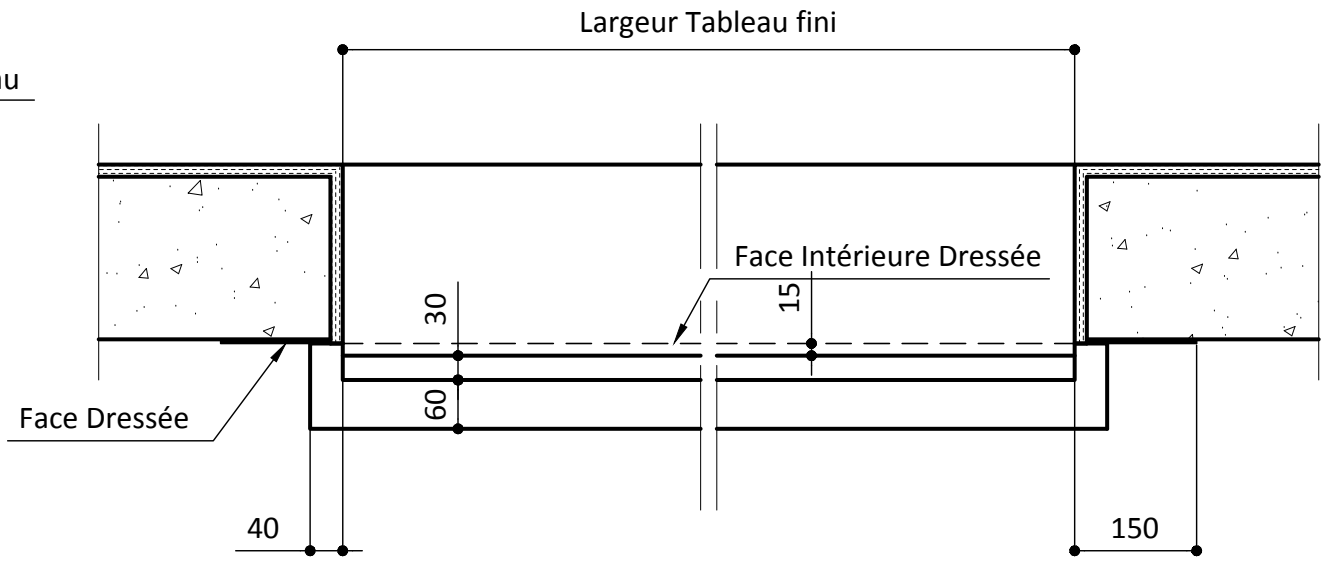

Désignation du plan :
 FRAPPE SEUIL PMR - POSE 1D100
 VR PREFE (enroulement ext. et int.)

Fichier : ResaCAIB_Pvc_P1.dwg

Des. : M.CHAUVIERE Ech : 1 / 10 DD7

Date : 09/01/2018 N° : 10231

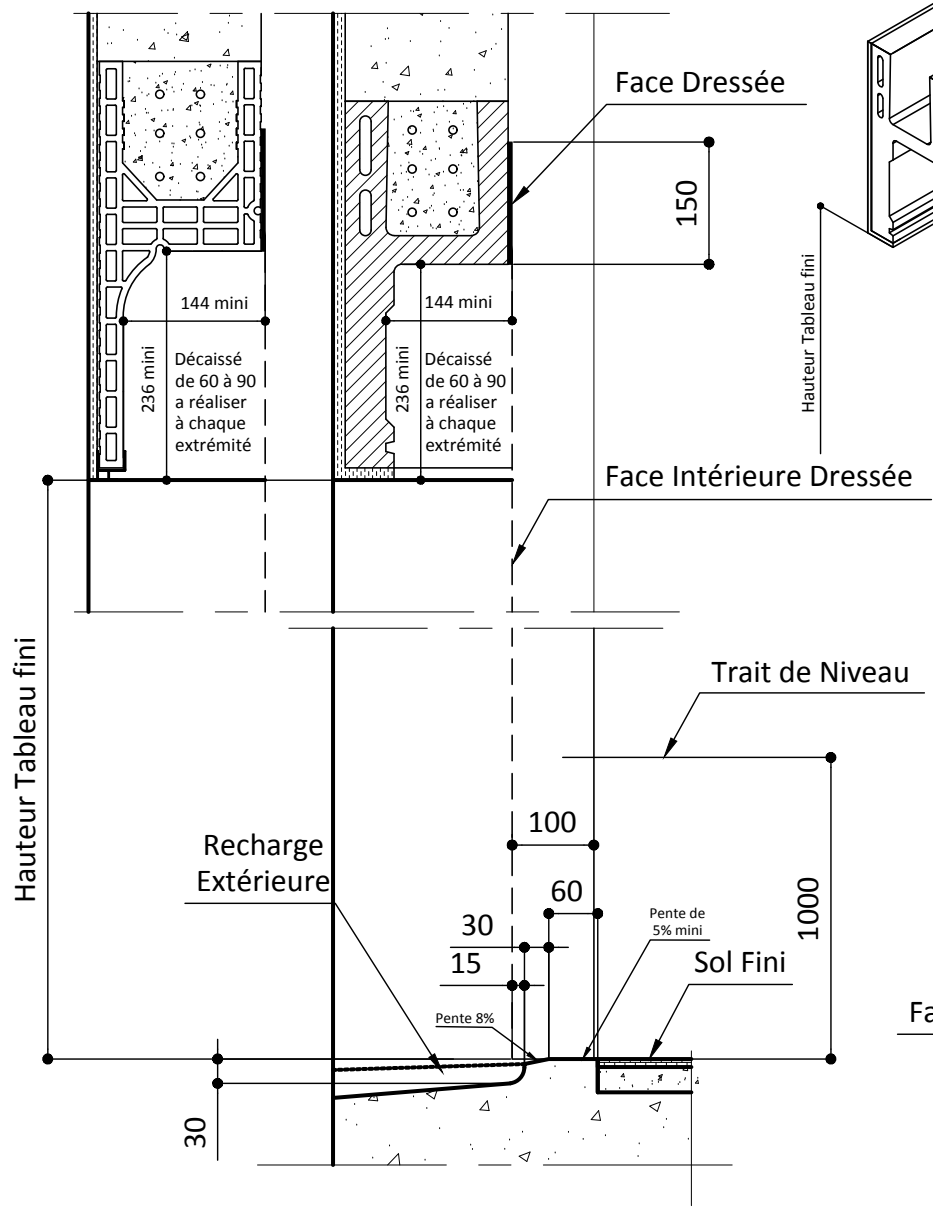

SEUIL PMR

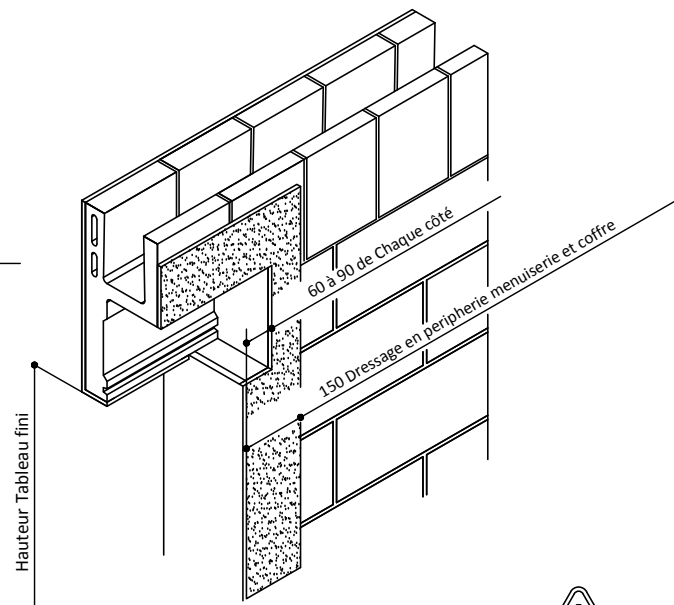

REPÈRE	TABLEAU FINI		SENS D'OUVERTURE	QTE
	HAUTEUR	LARGEUR		



ATTENTION! UTILISER UN TYPE DE DEMI-COFFRE PRÉCONISÉ PAR NOTRE B.E

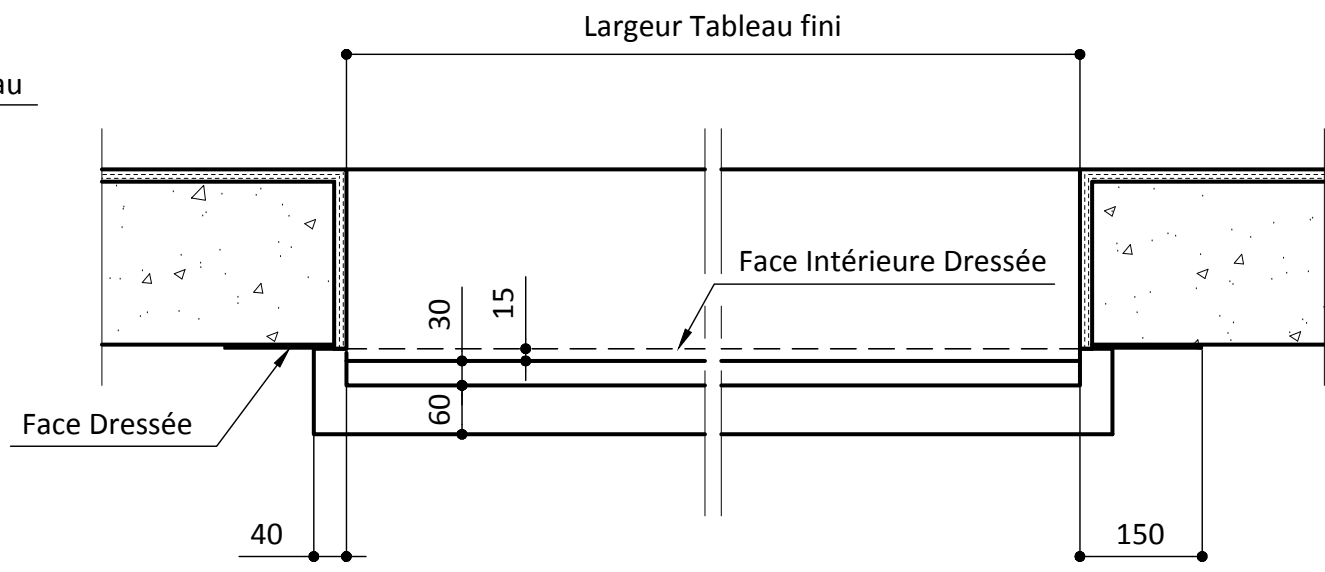

Désignation du plan :		
FRAPPE SEUIL PMR - POSE 1D100		
VR OPTIBAIE (pose dans demi-linteau)		
Fichier : ResaCAIB_Pvc_P1.dwg		
Des. : M.CHAUVIERE	Ech : 1 / 10	EE7
Date : 09/01/2018	N° :	10236

RESERVATIONS MAÇONNERIE
SI SEUILS ELARGIS en DOUBLAGE de 100mm

POSITIONNER L'APPUI MAÇONNERIE EN FONCTION DU SEUIL CHOISI

SUR ALLEGE
MAÇONNERIE

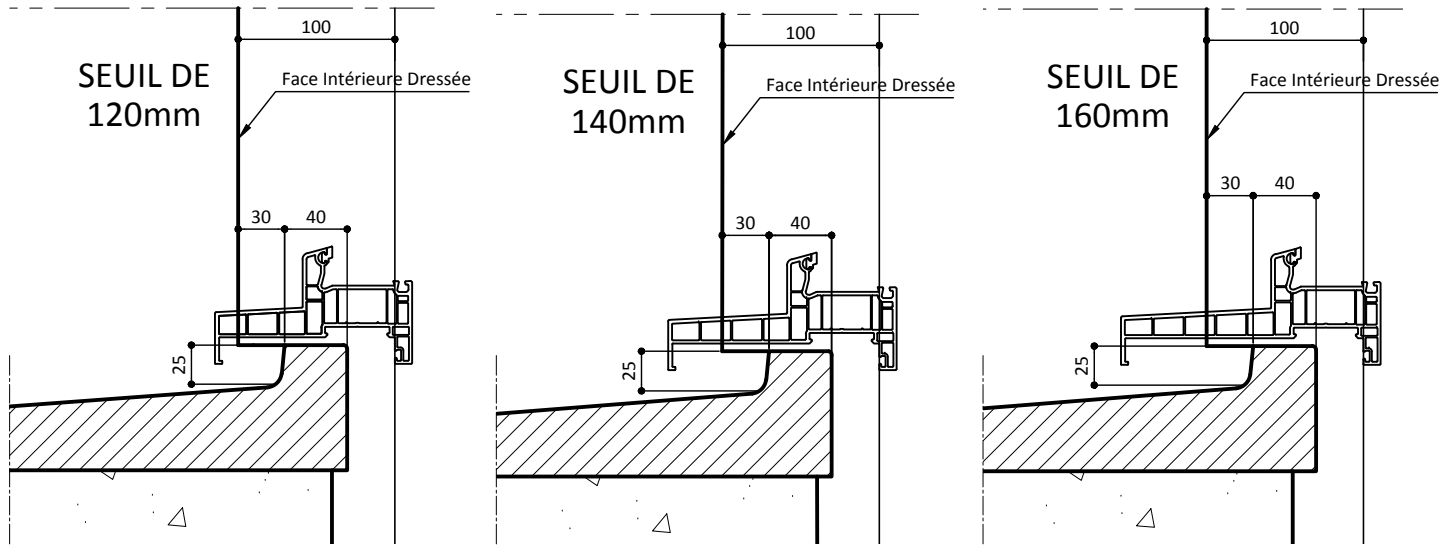

SUR SOL FINI

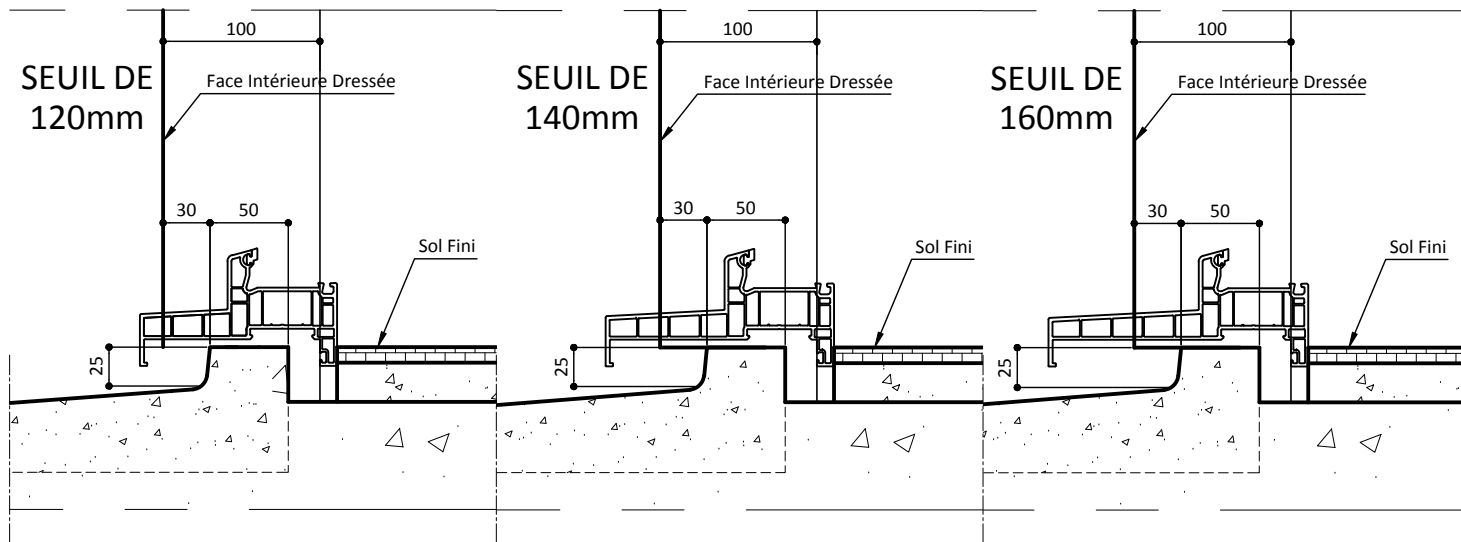

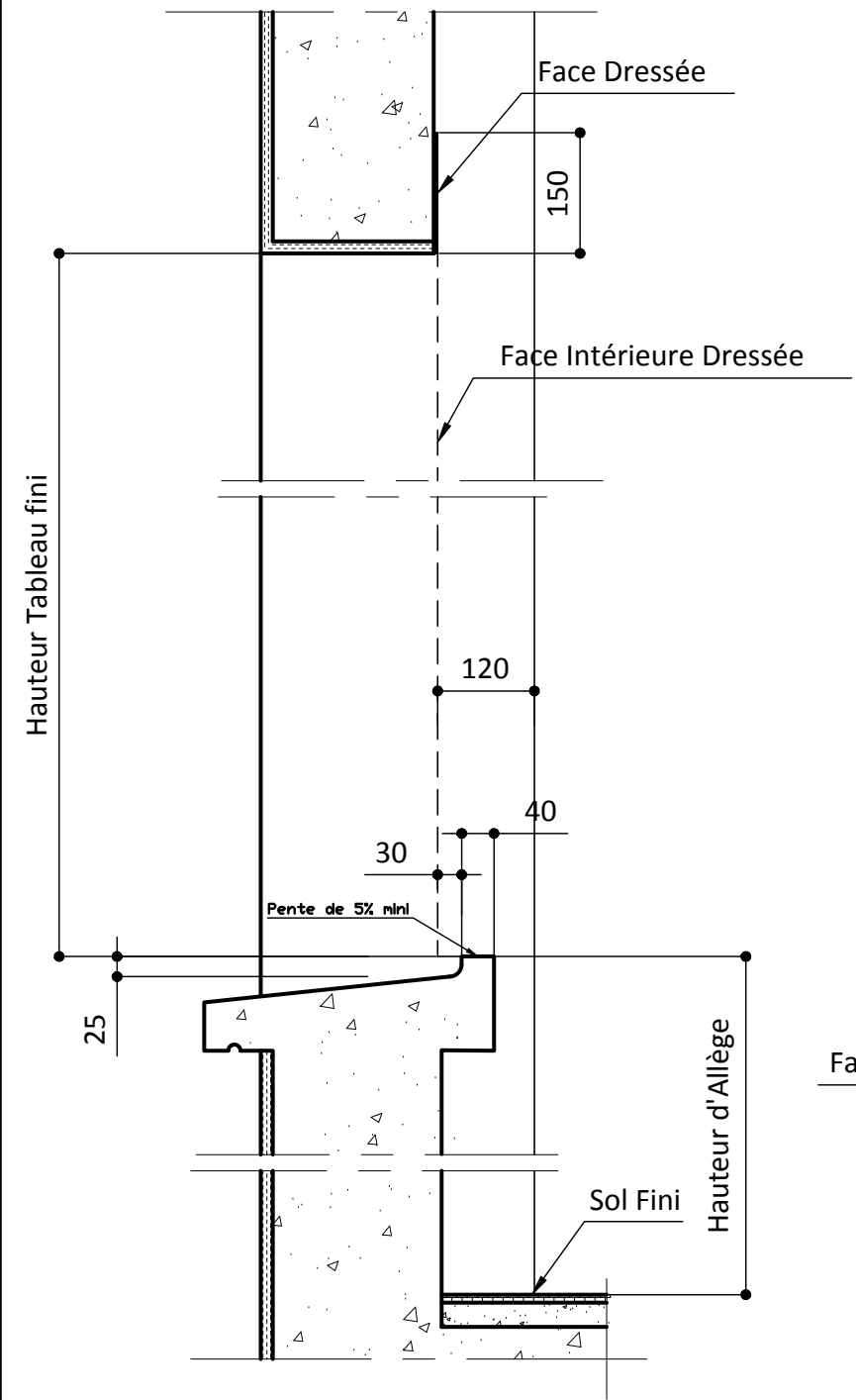

Désignation du plan :	
FRAPPE SEUIL ELARGI - POSE 1D100 SUR ALLEGE ET SOL FINI	
Fichier : ResaCAIB_Pvc_P1.dwg	
Des. : M.CHAUVIERE	Ech : 1 / 5 I17
Date : 09/01/2018	N° : 10256

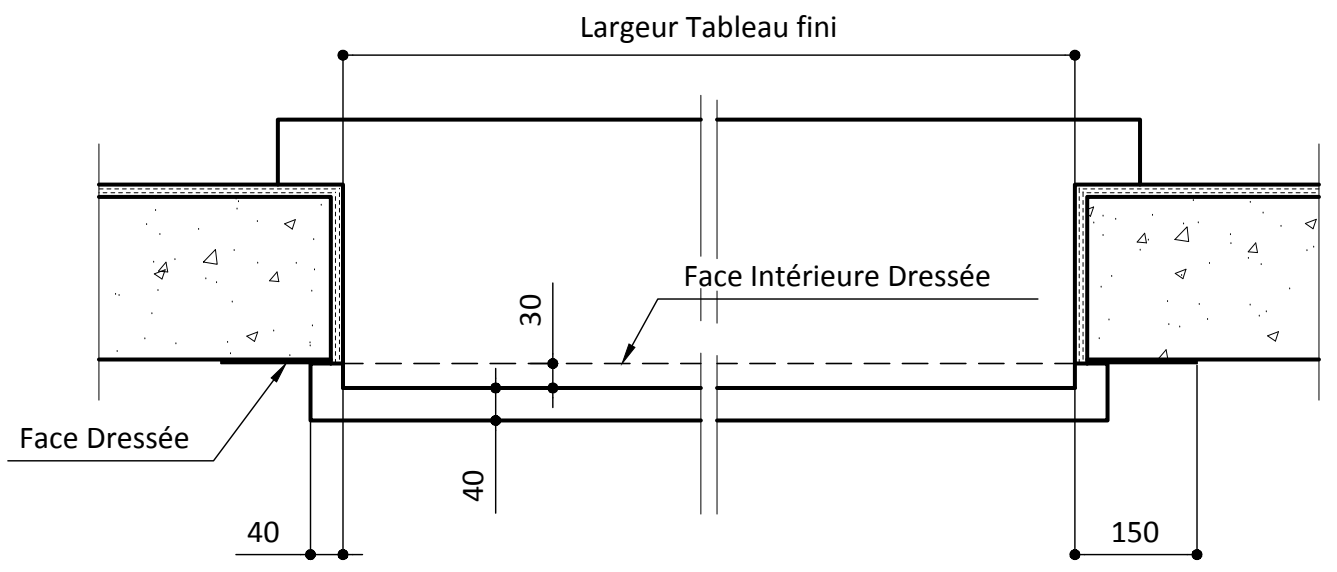

REPÈRE	TABLEAU FINI		SENS D'OUVERTURE	VITRAGE EXT / INT	OBSERVATIONS	QTE
	HAUTEUR	LARGEUR				







Désignation du plan :
FRAPPE SUR ALLEGE - POSE 1D120
SANS VR - VR EVIBAIE - VR TRADITIONNEL

Fichier : ResaCAIB_Pvc_P1.dwg

Des. : M.CHAUVIERE Ech : 1 / 10 T8

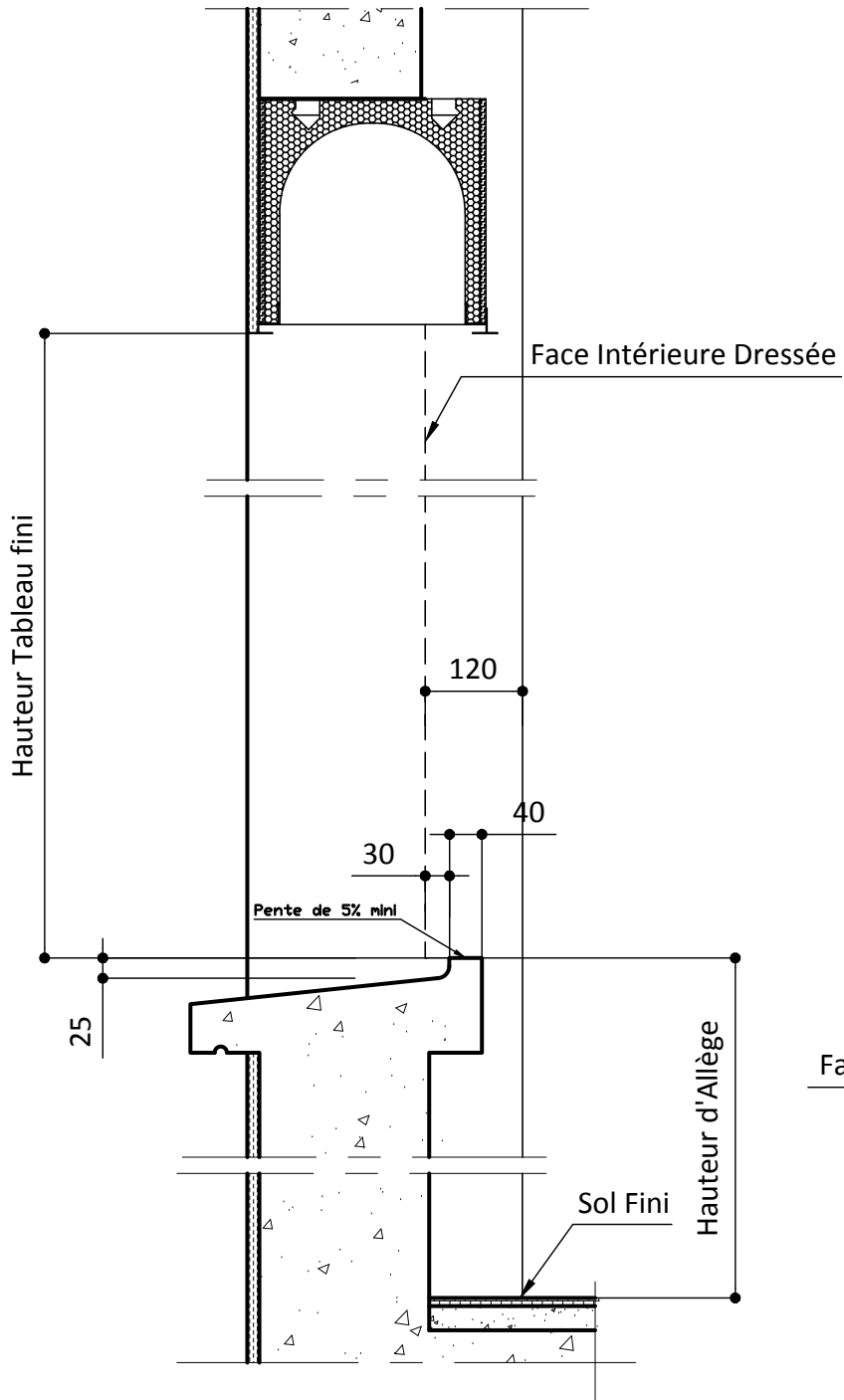
Date : 09/01/2018 N° : 10271



REPERE	TABLEAU FINI		SENS D'OUVERTURE	VITRAGE EXT / INT	OBSERVATIONS	QTE
	HAUTEUR	LARGEUR				

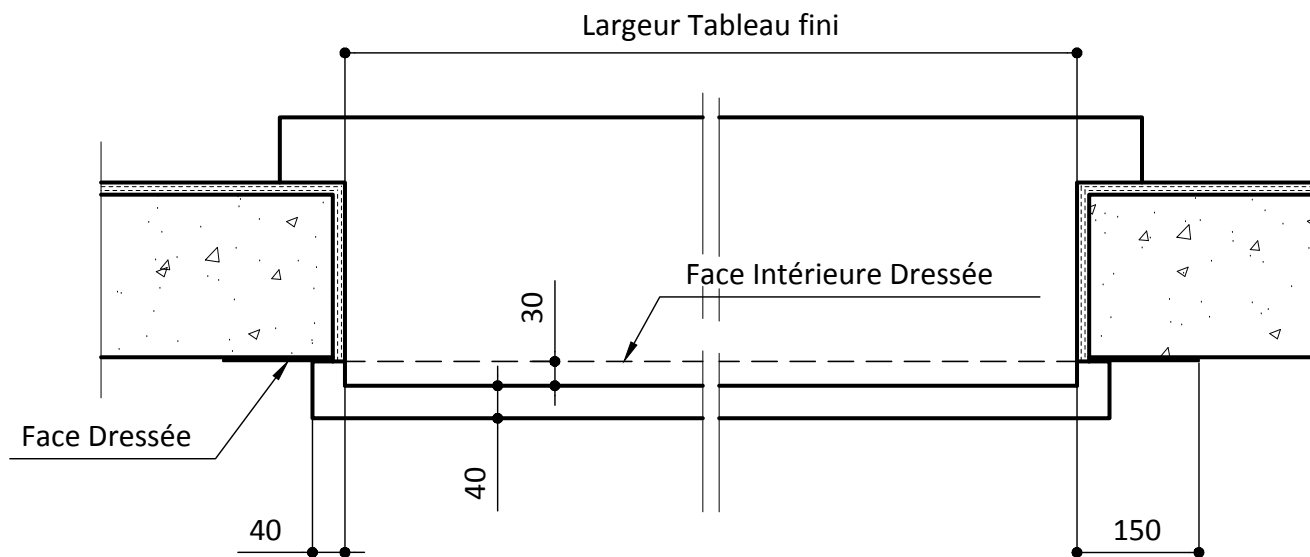

Désignation du plan :
 FRAPPE SUR ALLEGE - POSE 1D120
 VR PREFA (enroulement ext. et int.)

Fichier : ResaCAIB_Pvc_P1.dwg

Des. : M.CHAUVIERE Ech : 1 / 10 U8

Date : 09/01/2018 N° : 10276

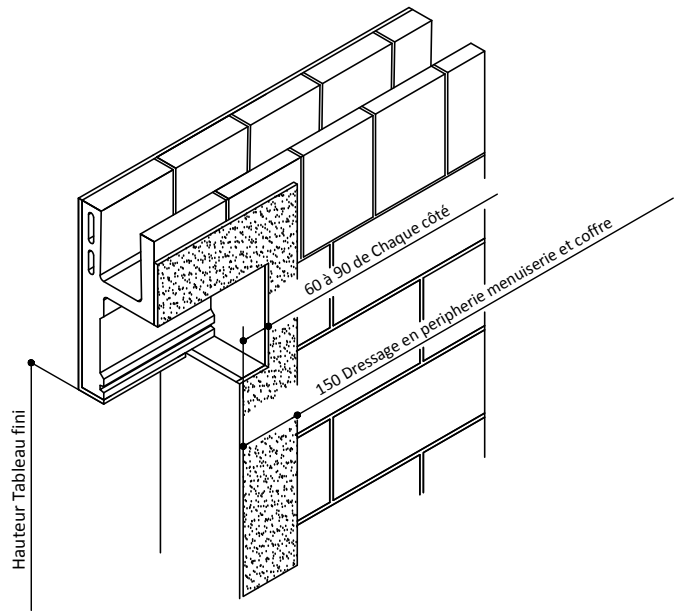
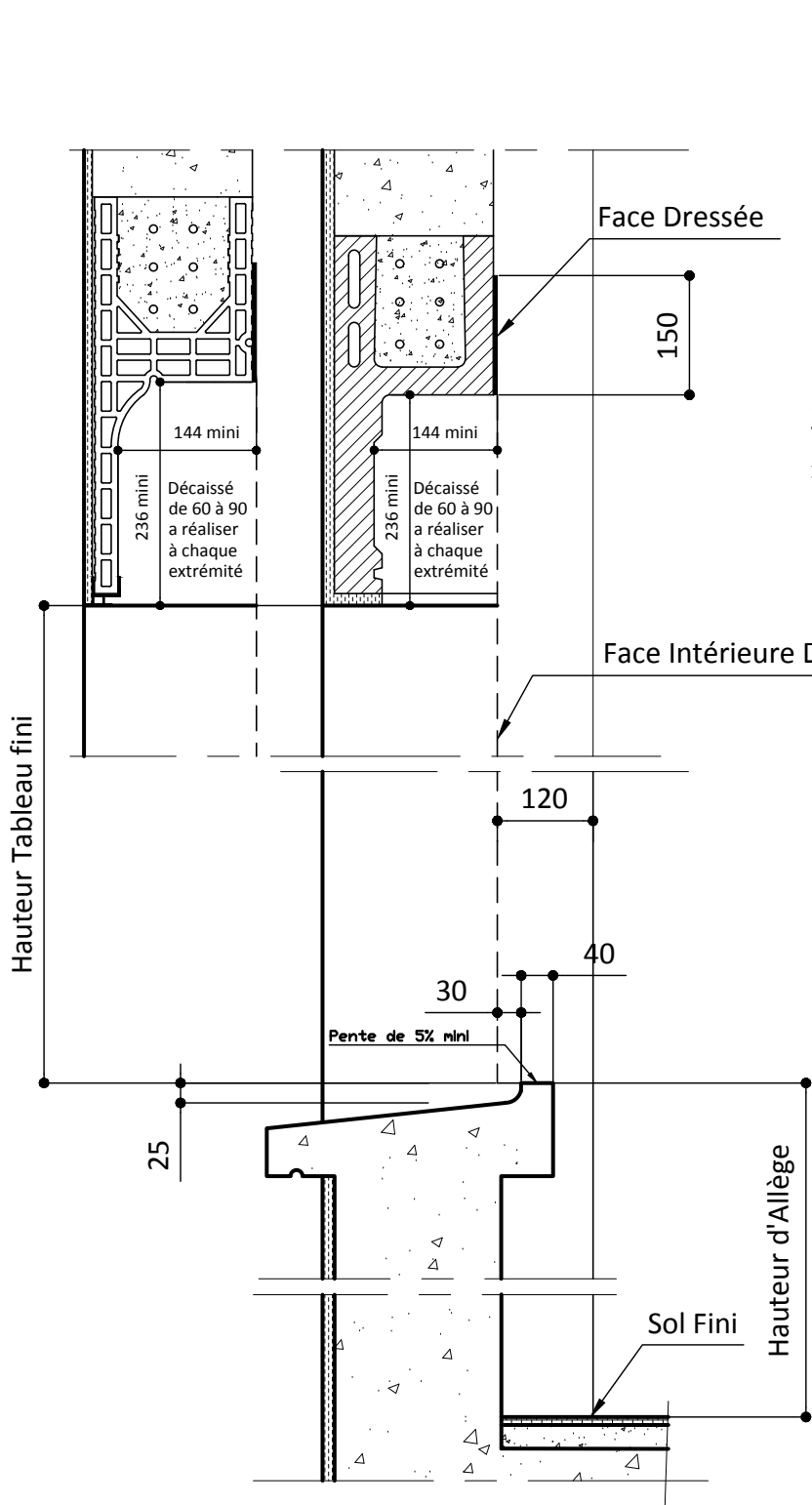

REPÈRE	TABLEAU FINI		SENS D'OUVERTURE	QTE
	HAUTEUR	LARGEUR		



ATTENTION! UTILISER UN TYPE DE DEMI-COFFRE PRÉCONISÉ PAR NOTRE B.E

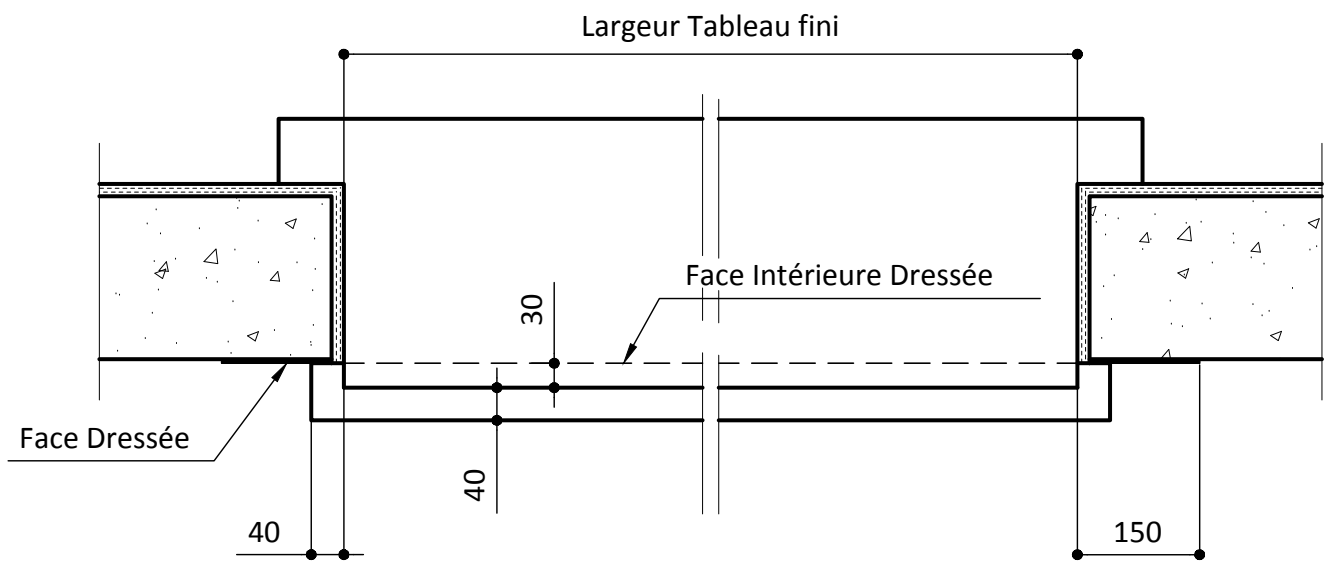

Désignation du plan :
 FRAPPE SUR ALLEGE - POSE 1D120
 VR OPTIBAIE (pose dans demi-linteau)

Fichier : ResaCAIB_Pvc_P1.dwg

Des. : M.CHAUVIERE Ech : 1 / 10 V8

Date : 09/01/2018 N° : 10281

REPÈRE	TABLEAU FINI		SENS D'OUVERTURE	VITRAGE EXT / INT	OBSERVATIONS	QTE
	HAUTEUR	LARGEUR				

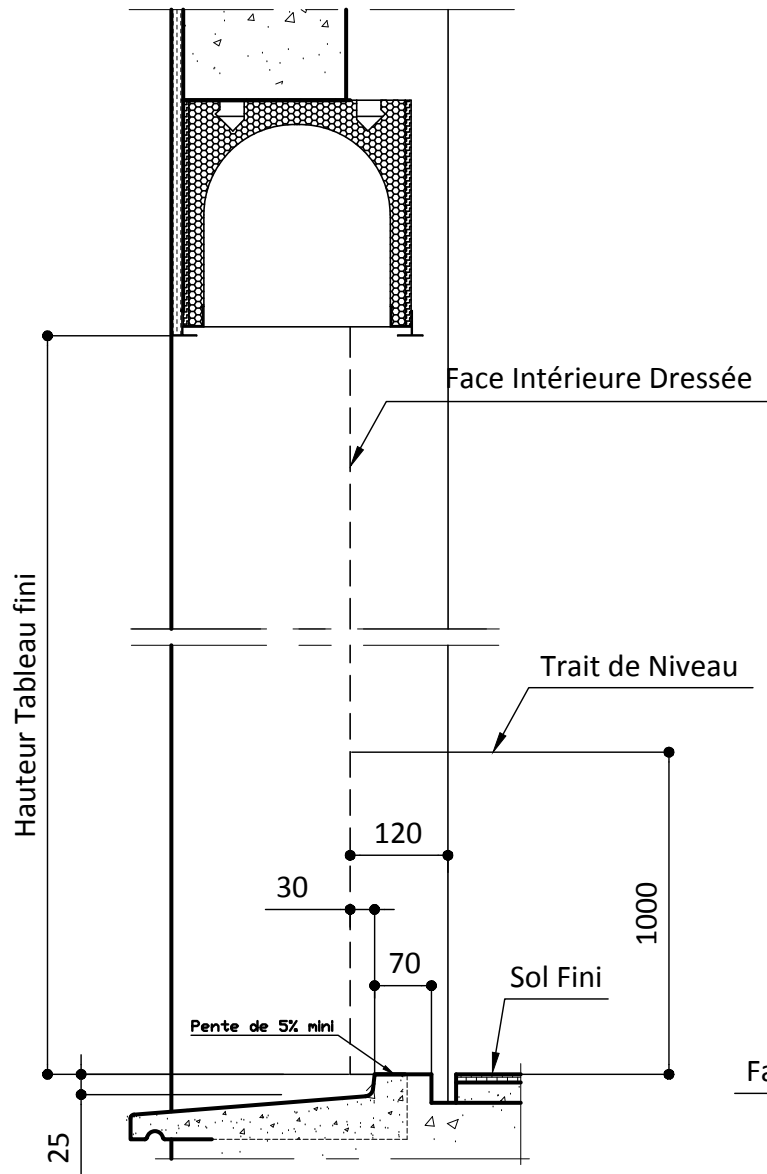

SEUIL STANDARD

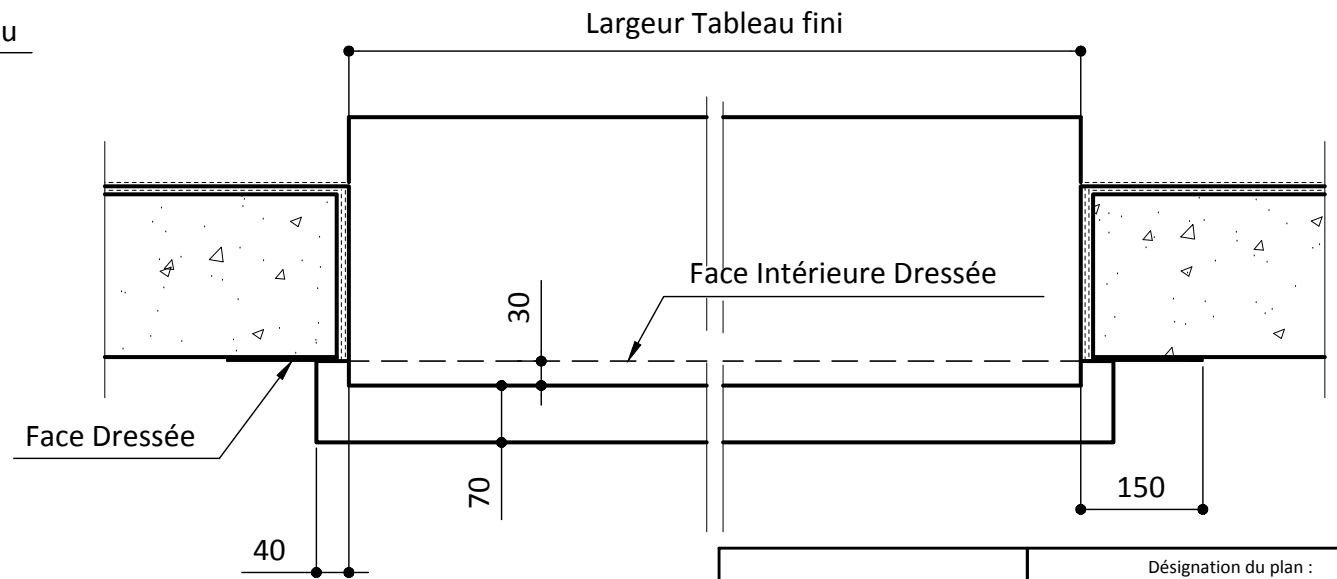

Désignation du plan :
FRAPPE SUR SOL FINI - POSE 1D120
VR PREFE (enroulement ext. et int.)
Fichier : ResaCAIB_Pvc_P1.dwg
Des. : M.CHAUVIERE Ech : 1 / 10 X8
Date : 09/01/2018 N° : 10291

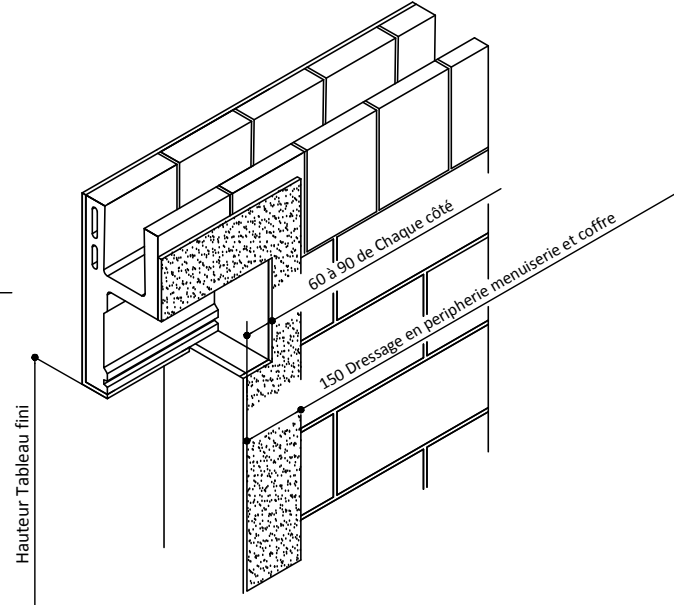

REPÈRE	TABLEAU FINI		SENS D'OUVERTURE	QTE
	HAUTEUR	LARGEUR		



ATTENTION! UTILISER UN TYPE DE DEMI-COFFRE PRÉCONISÉ PAR NOTRE B.E

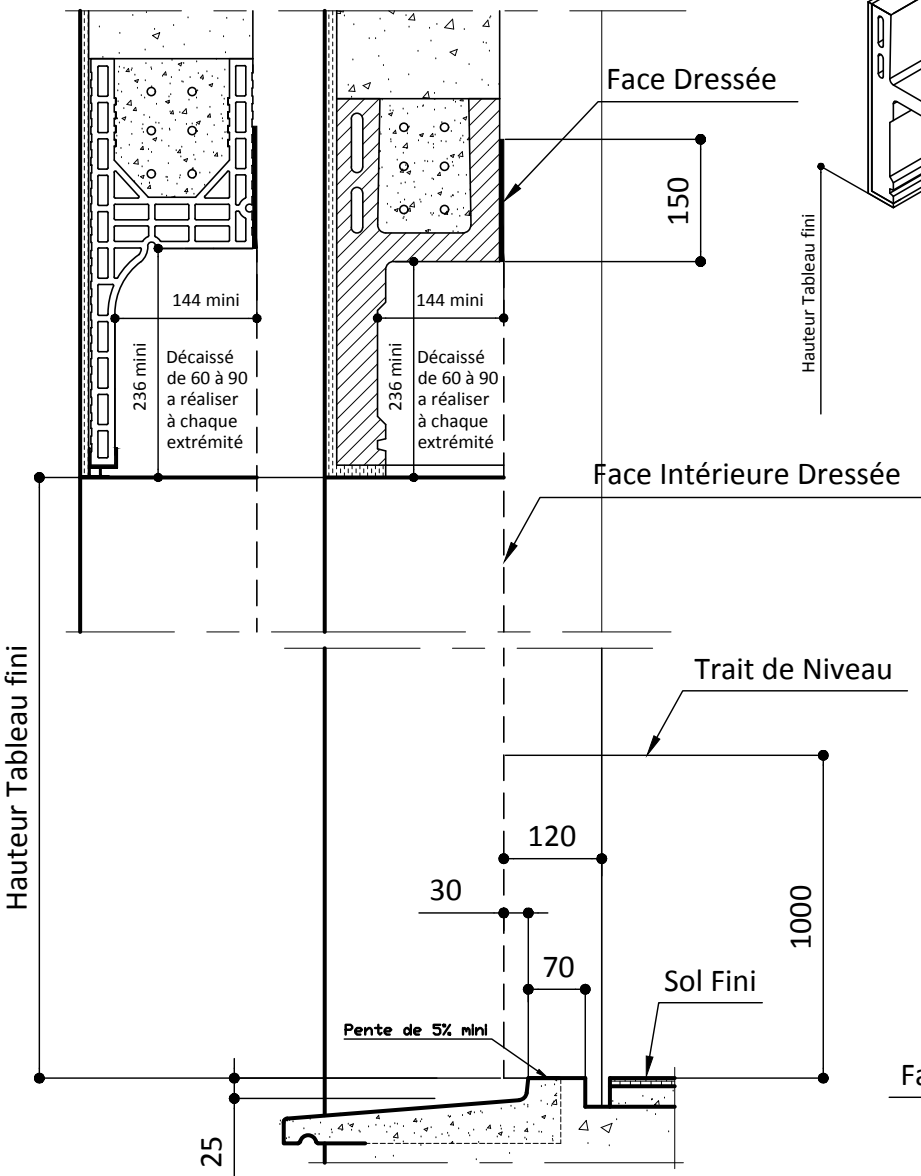

SEUIL STANDARD

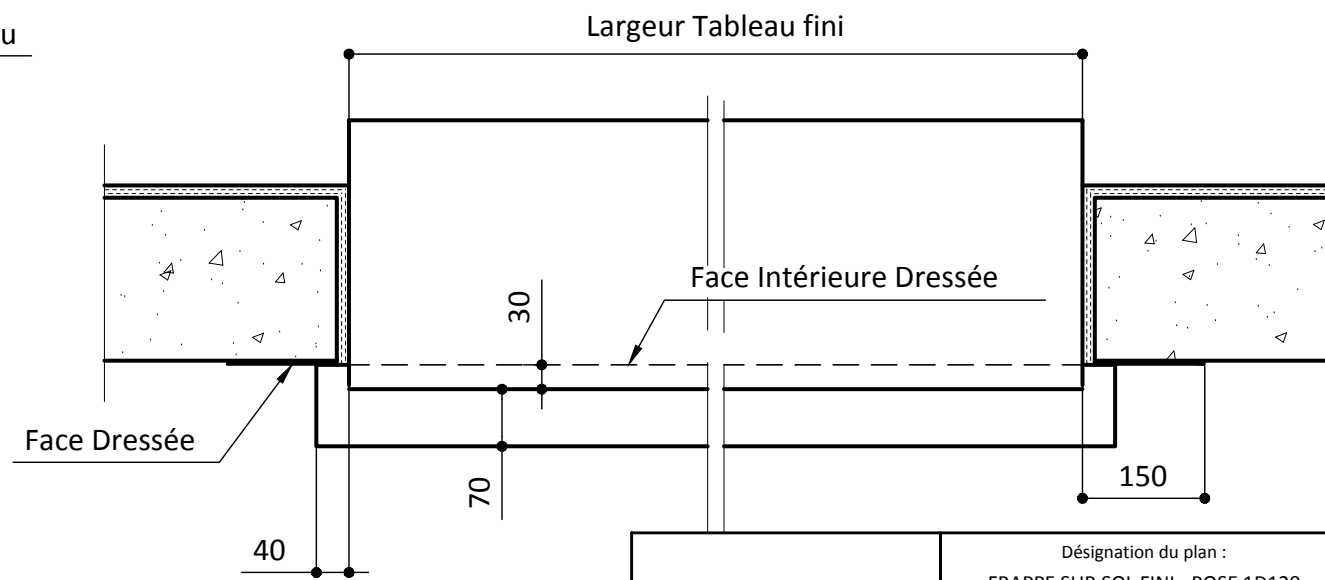

Désignation du plan :
 FRAPPE SUR SOL FINI - POSE 1D120
 VR OPTIBAIE (pose dans demi-linteau)

Fichier : ResaCAIB_Pvc_P1.dwg

Des. : M.CHAUVIERE Ech : 1 / 10 Y8

Date : 09/01/2018 N° : 10296

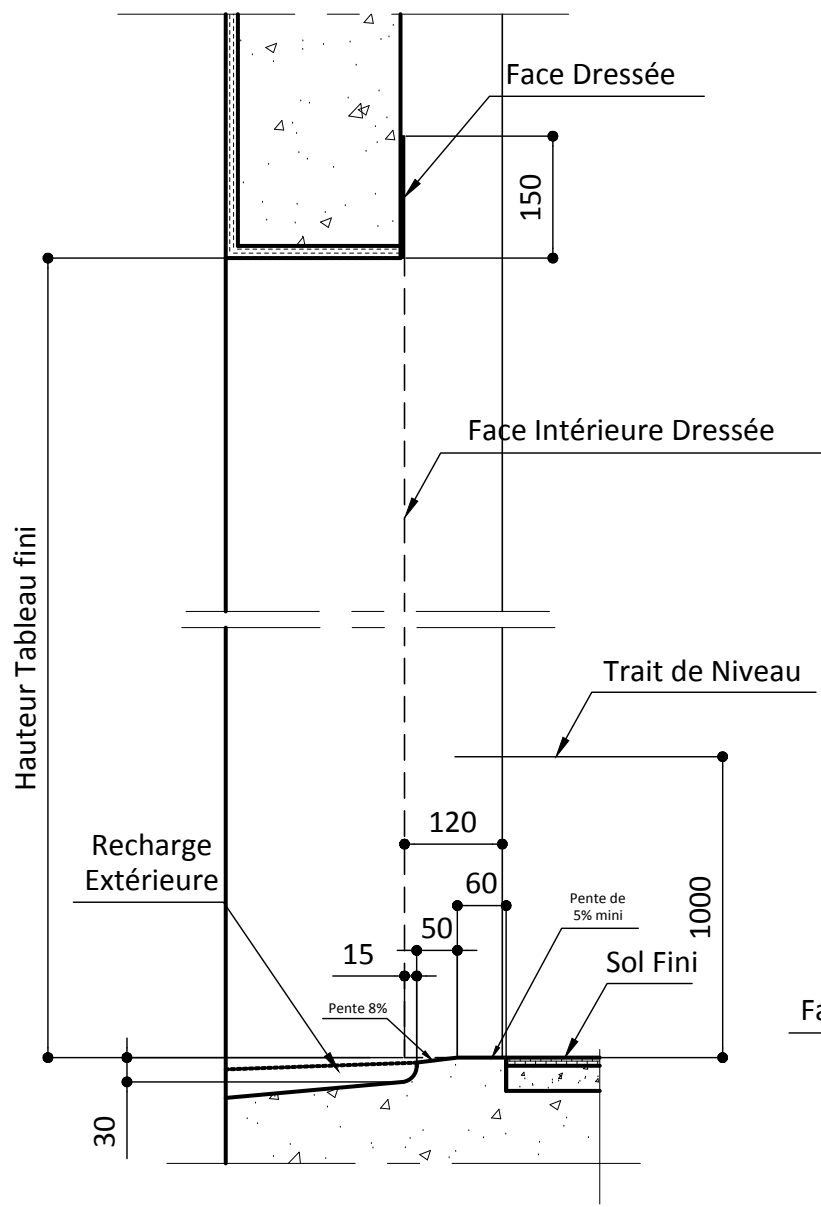

SEUIL PMR

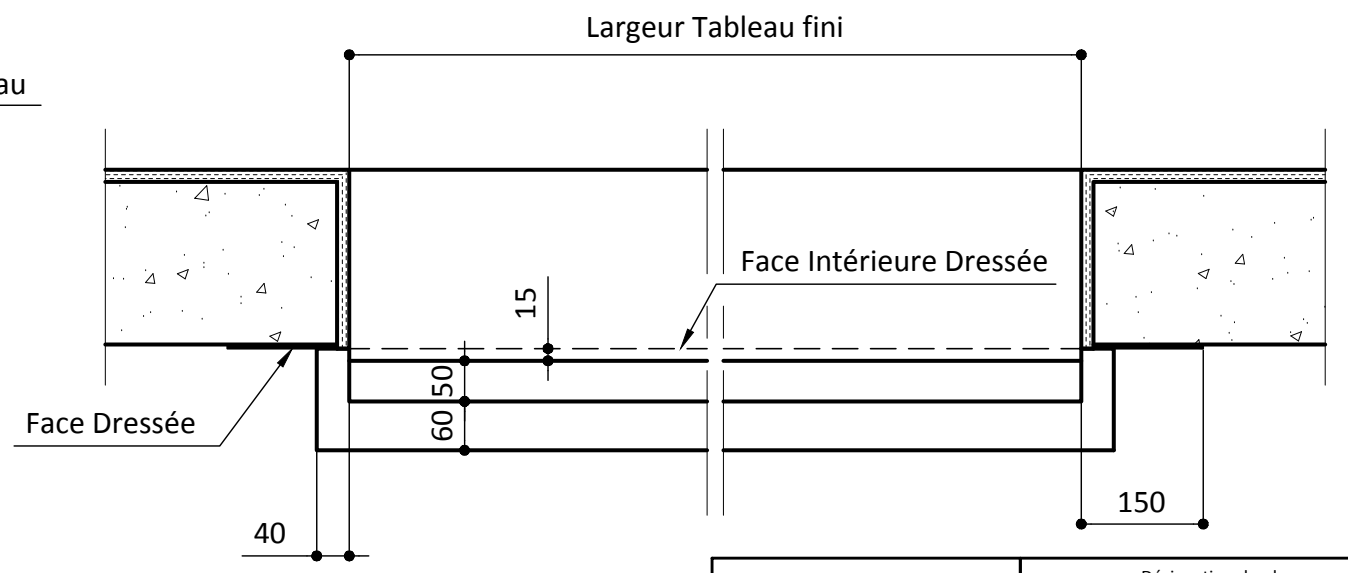

REPERE	TABLEAU FINI		SENS D'OUVERTURE	VITRAGE EXT / INT	OBSERVATIONS	QTE
	HAUTEUR	LARGEUR				



Désignation du plan :
 FRAPPE SEUIL PMR - POSE 1D120
 VR EVIBAIE - VR TRADITIONNEL

Fichier : ResaCAIB_Pvc_P1.dwg

Des. : M.CHAUVIERE Ech : 1 / 10 BB8

Date : 09/01/2018 N° : 10311

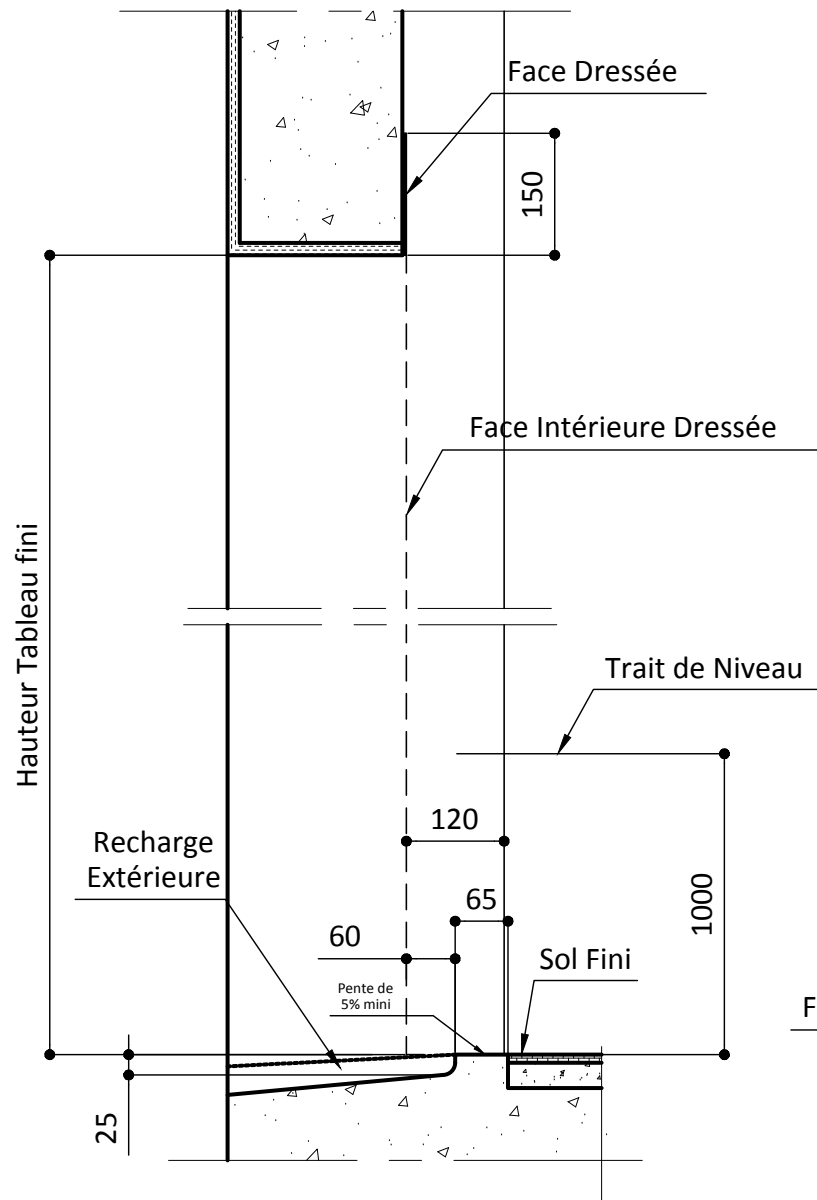

SEUIL PMR

REPÈRE	TABLEAU FINI		SENS D'OUVERTURE	VITRAGE EXT / INT	OBSERVATIONS	QTE
	HAUTEUR	LARGEUR				

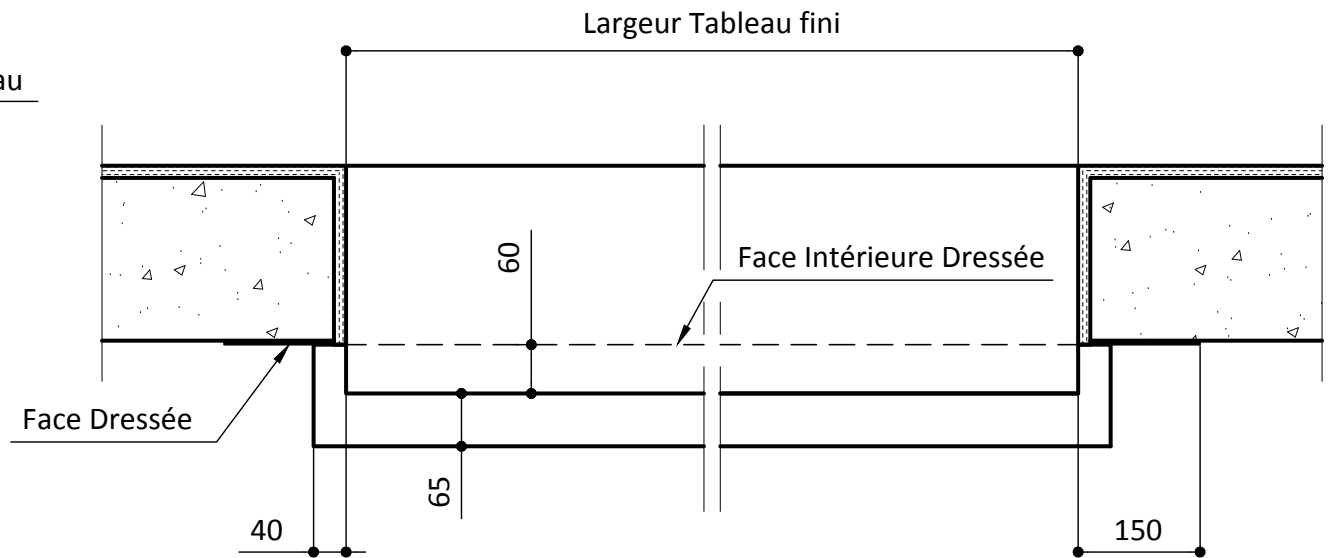

Désignation du plan :
 FRAPPE SEUIL PMR - POSE 1D120
 SANS VR

Fichier : ResaCAIB_Pvc_P1.dwg

Des. : M.CHAUVIERE Ech : 1 / 10 CC8

Date : 09/01/2018 N° : 10316

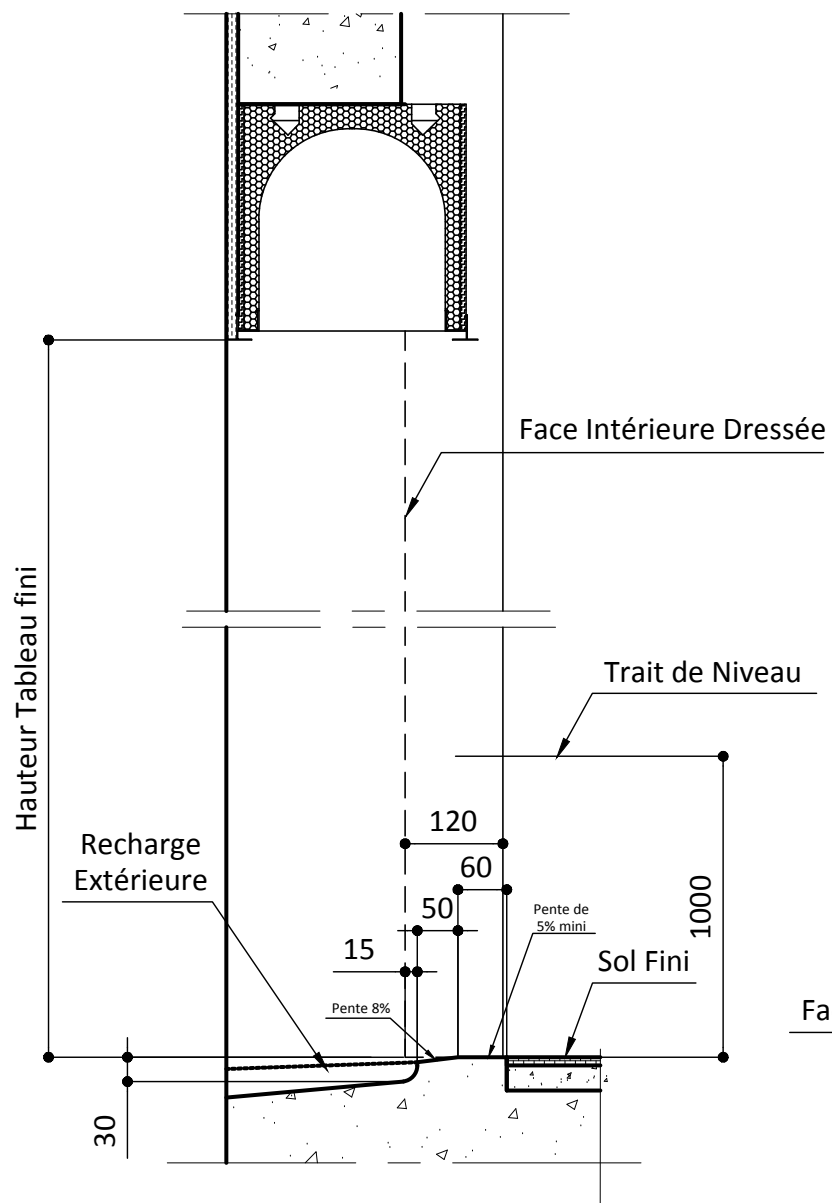

SEUIL PMR

REPERE	TABLEAU FINI		SENS D'OUVERTURE	VITRAGE EXT / INT	OBSERVATIONS	QTE
	HAUTEUR	LARGEUR				

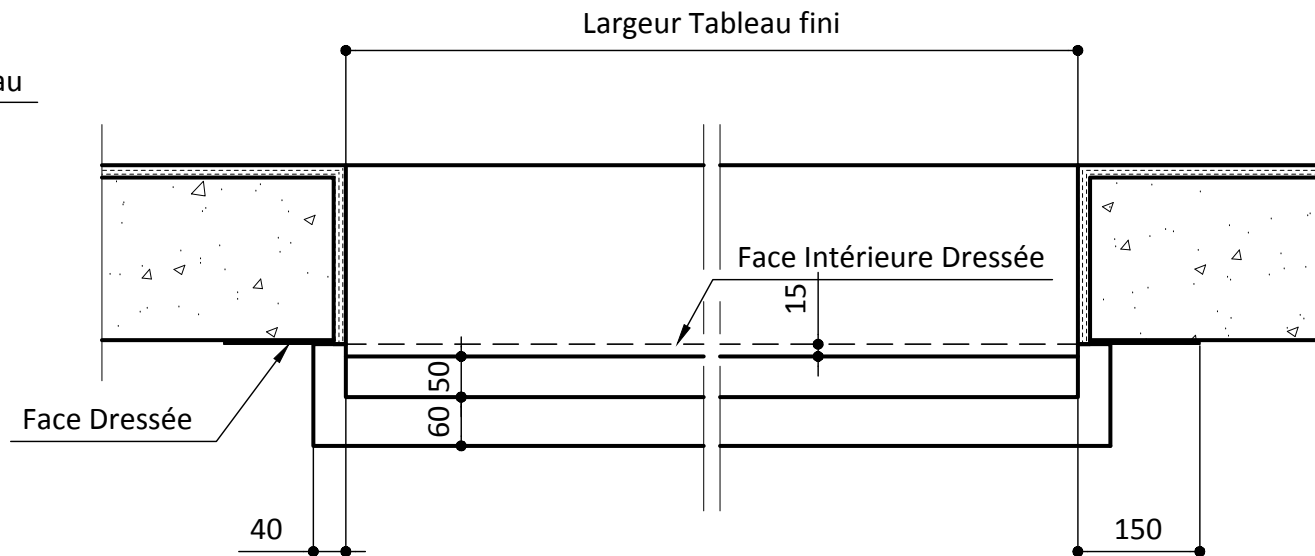

Désignation du plan :
 FRAPPE SEUIL PMR - POSE 1D120
 VR PREFA (enroulement ext. et int.)
 Fichier : ResaCAIB_Pvc_P1.dwg
 Des. : M.CHAUVIERE Ech : 1 / 10 DD8
 Date : 09/01/2018 N° : 10321

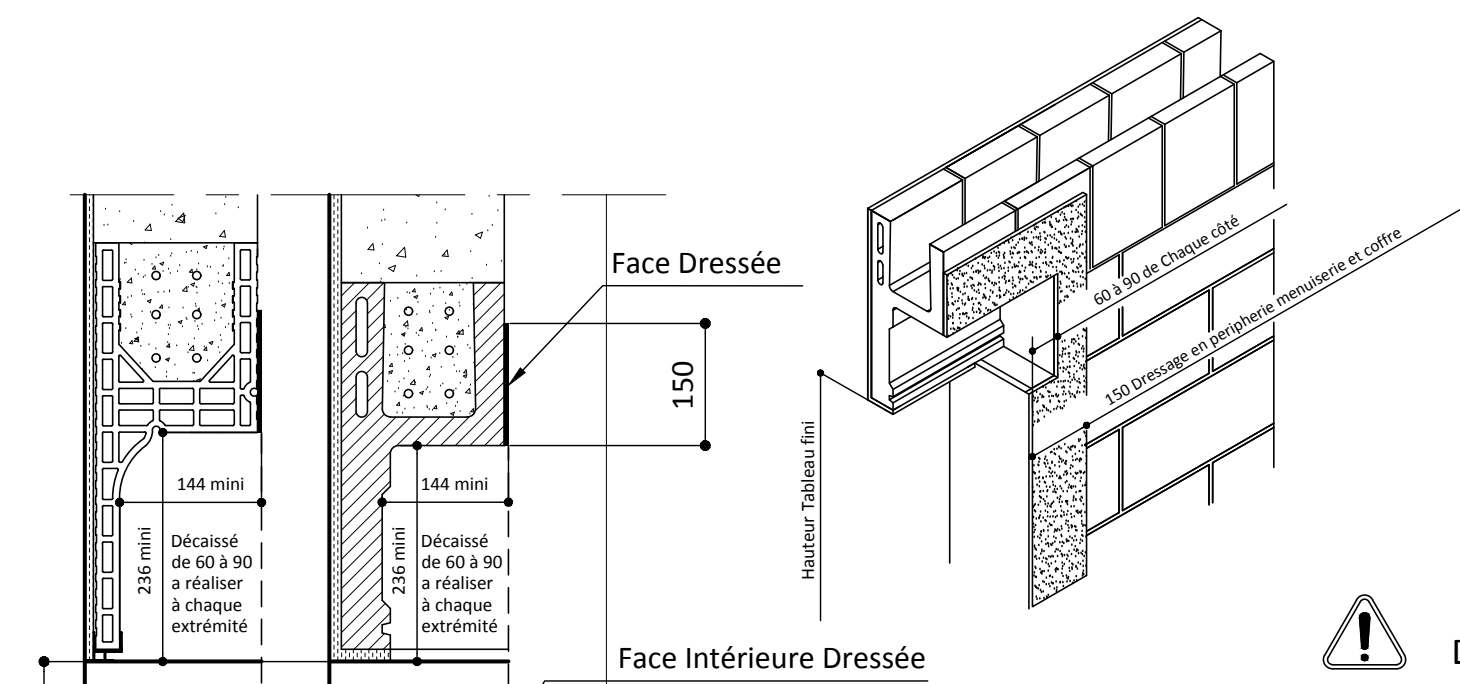

REPÈRE	TABLEAU FINI		SENS D'OUVERTURE	QTE
	HAUTEUR	LARGEUR		

ATTENTION! UTILISER UN TYPE DE DEMI-COFFRE PRÉCONISÉ PAR NOTRE B.E

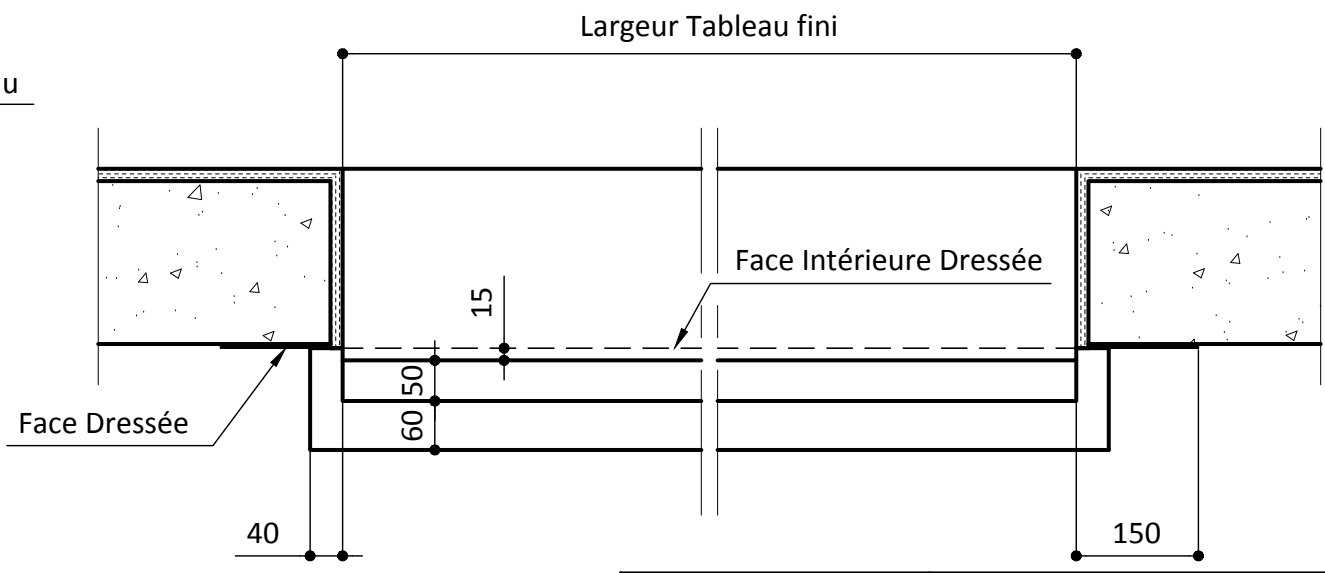
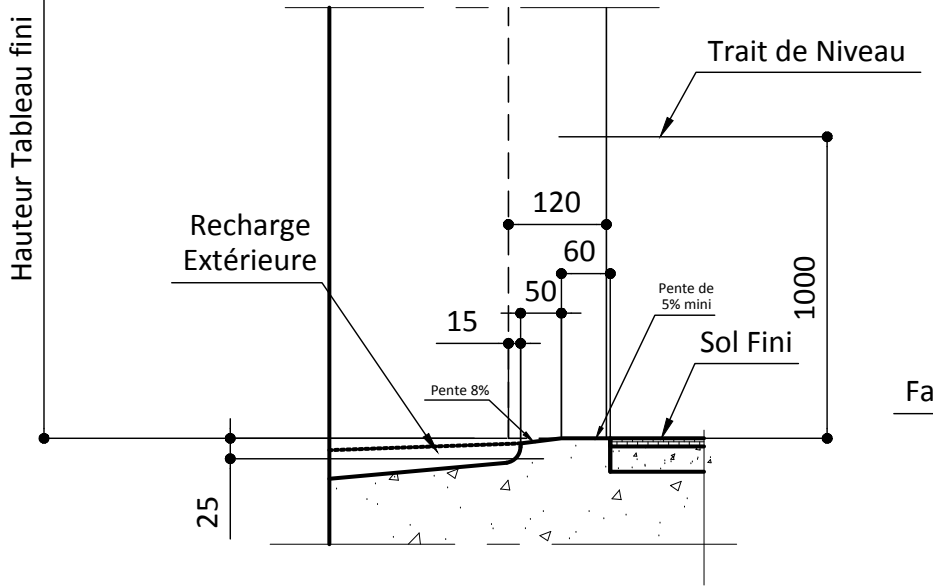

SEUIL PMR



Désignation du plan : FRAPPE SEUIL PMR - POSE 1D120 VR OPTIBAIE (pose dans demi-linteau)		
Fichier : ResaCAIB_Pvc_P1.dwg		
Des. : M.CHAUVIERE	Ech : 1 / 10	EE8
Date : 09/01/2018	N° :	10326

RESERVATIONS MAÇONNERIE
SI SEUILS ELARGIS en DOUBLAGE de 120mm

POSITIONNER L'APPUI MAÇONNERIE EN FONCTION DU SEUIL CHOISI

SUR ALLEGE
MAÇONNERIE

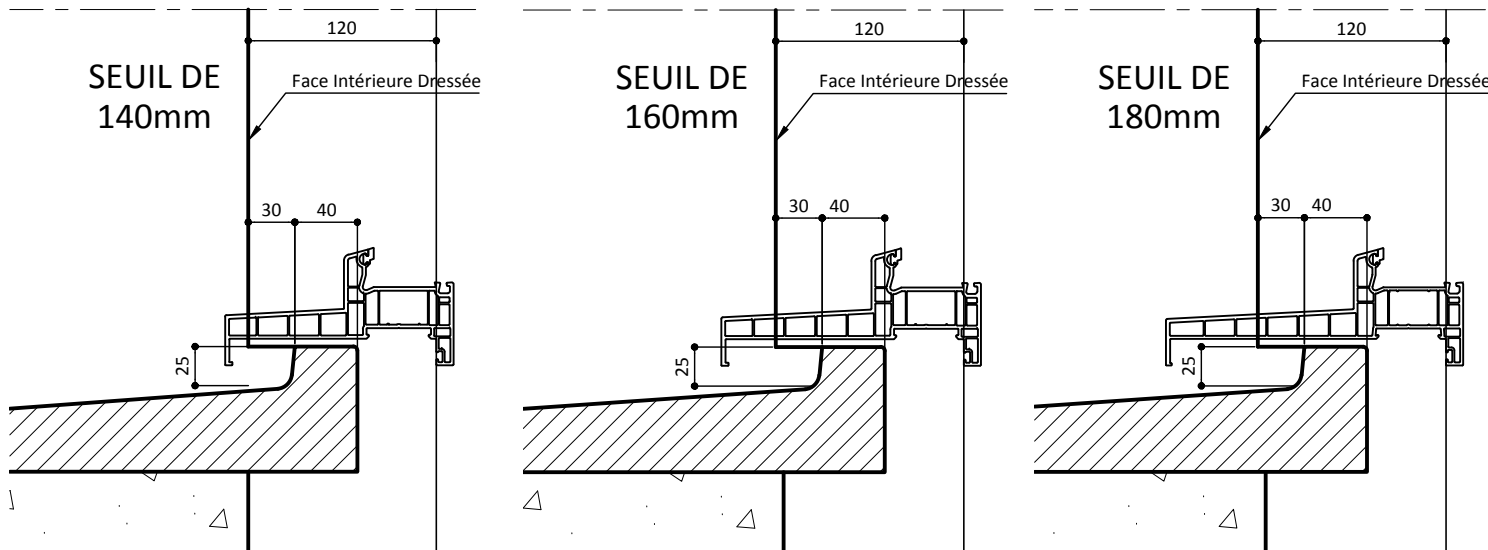

SUR SOL FINI

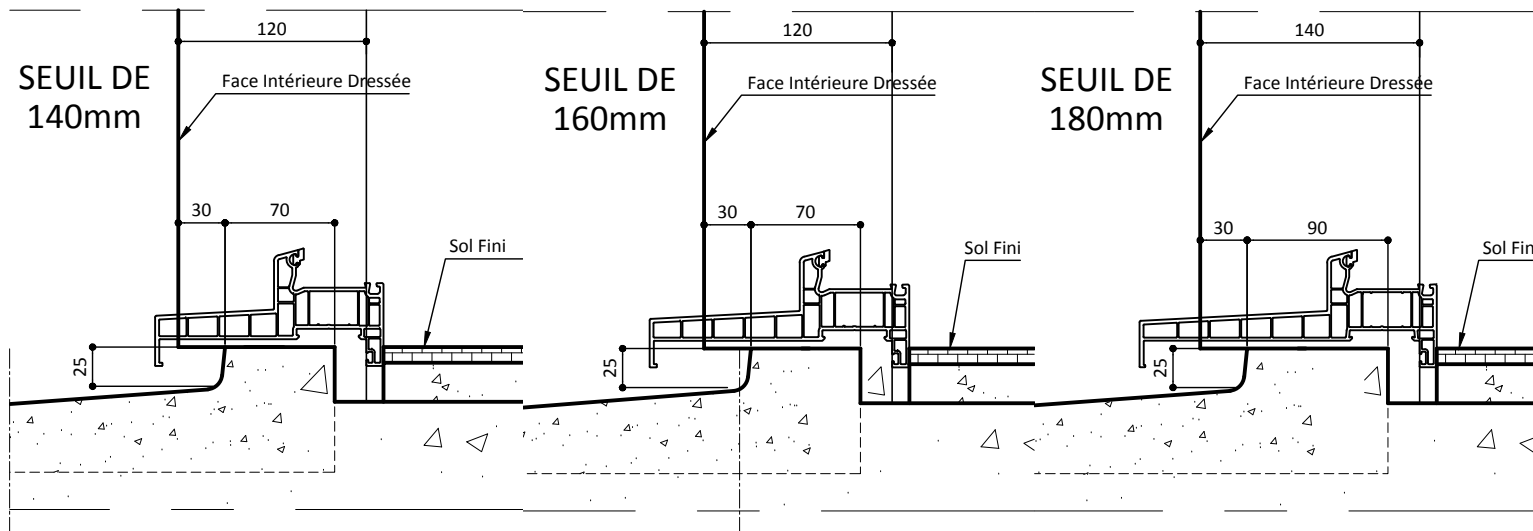

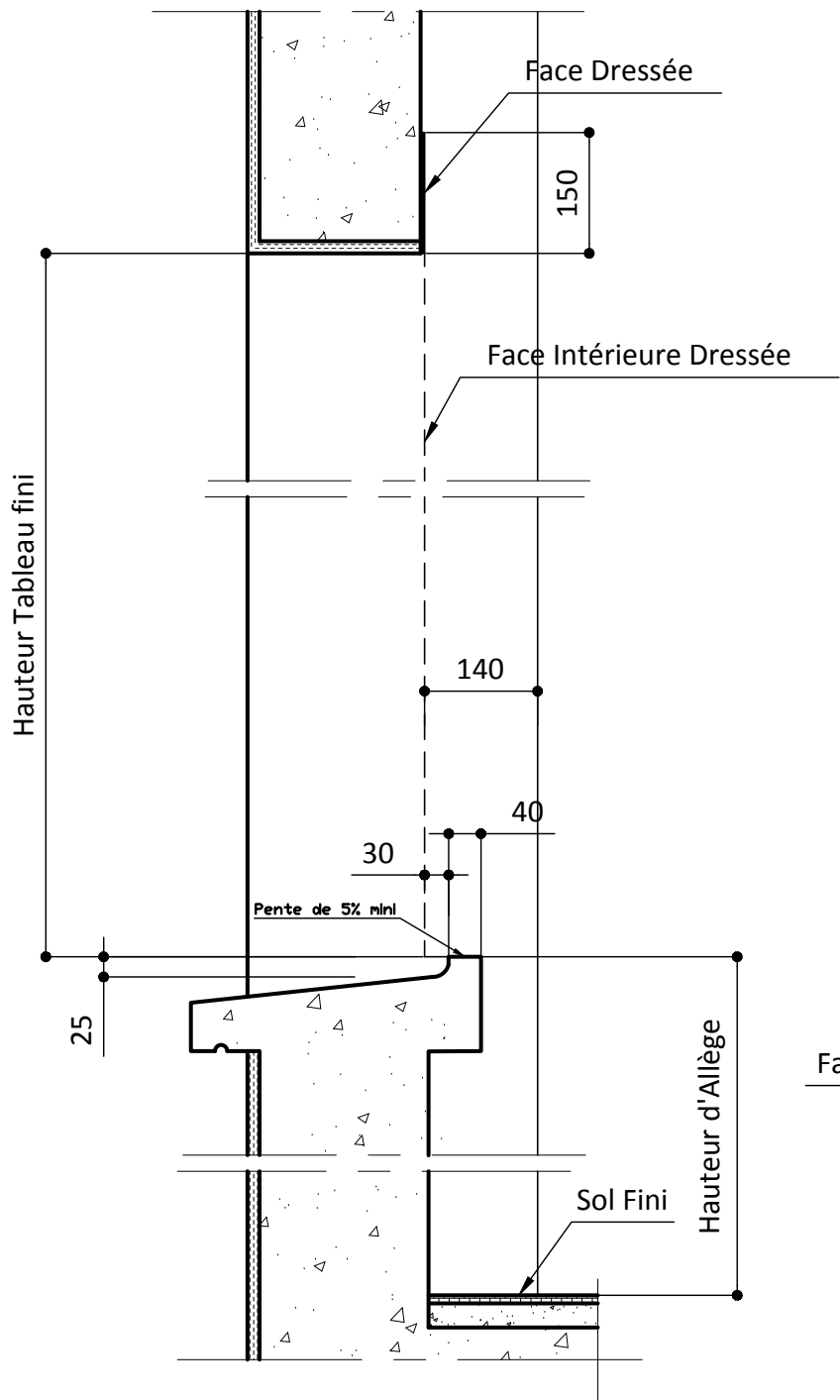

Désignation du plan :	
FRAPPE SEUIL ELARGI - POSE 1D120 SUR ALLEGE ET SOL FINI	
Fichier : ResaCAIB_Pvc_P1.dwg	
Des. : M.CHAUVIERE	Ech : 1 / 5 I18
Date : 09/01/2018	N° : 10346

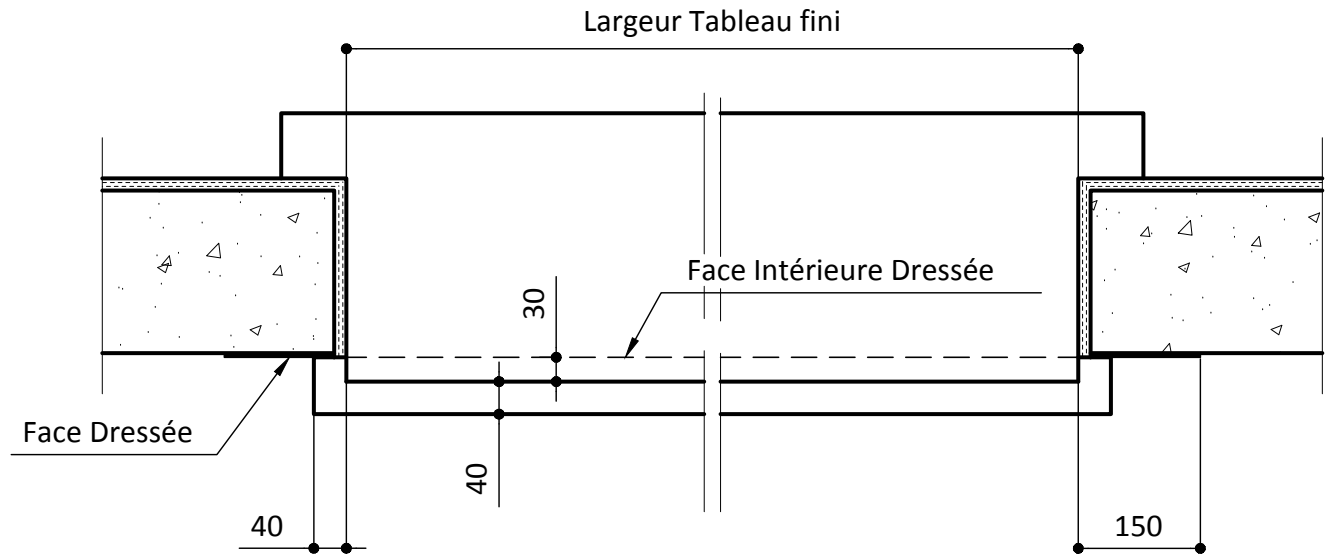

REPÈRE	TABLEAU FINI		SENS D'OUVERTURE	VITRAGE EXT / INT	OBSERVATIONS	QTE
	HAUTEUR	LARGEUR				



 	Désignation du plan : FRAPPE SUR ALLEGE - POSE 1D140 SANS VR - VR EVIBAIE - VR TRADITIONNEL	
	Fichier : ResaCAIB_Pvc_P1.dwg	
Des. : M.CHAUVIERE	Ech : 1 / 10	T9
Date : 09/01/2018	N° :	10361

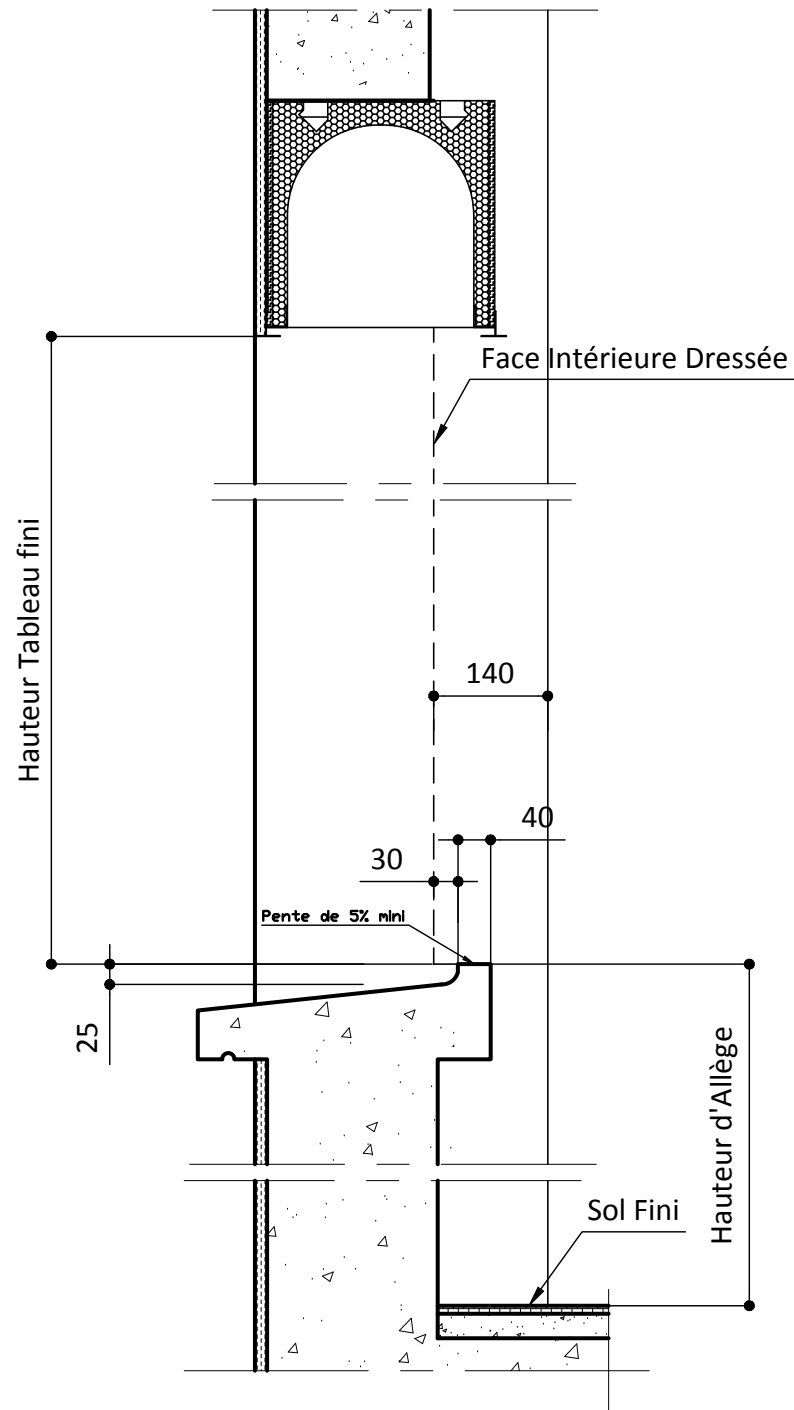

REPERE	TABLEAU FINI		SENS D'OUVERTURE	VITRAGE EXT / INT	OBSERVATIONS	QTE
	HAUTEUR	LARGEUR				

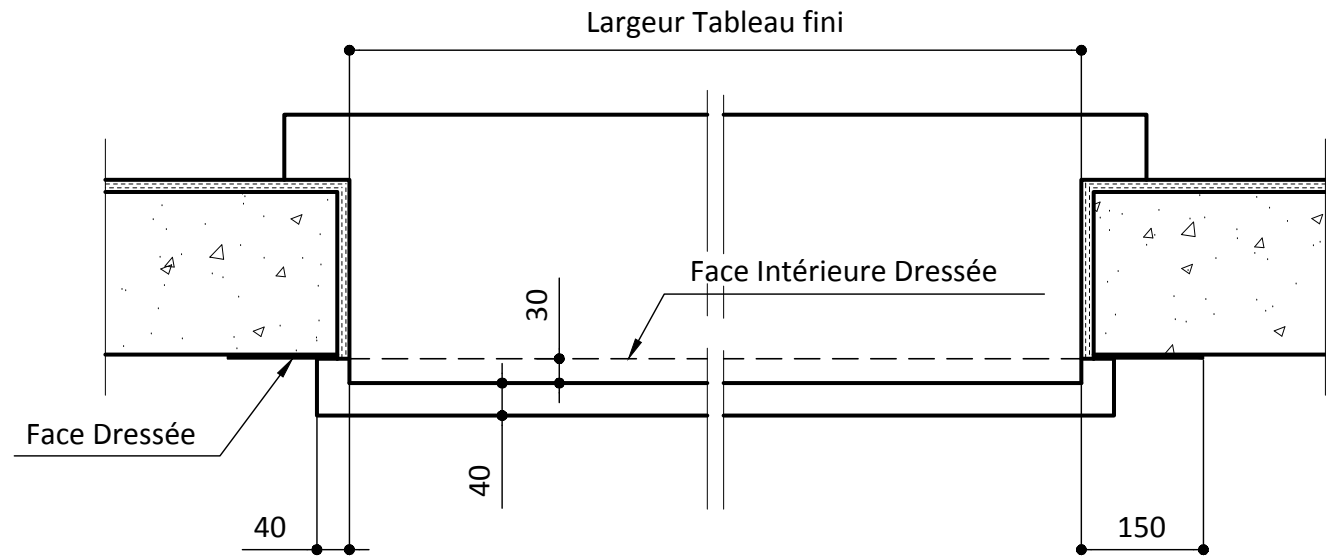

Désignation du plan :
 FRAPPE SUR ALLEGE - POSE 1D140
 VR PREFA (enroulement ext. et int.)

Fichier : ResaCAIB_Pvc_P1.dwg

Des. : M.CHAUVIERE Ech : 1 / 10 U9

Date : 09/01/2018 N° : 10366

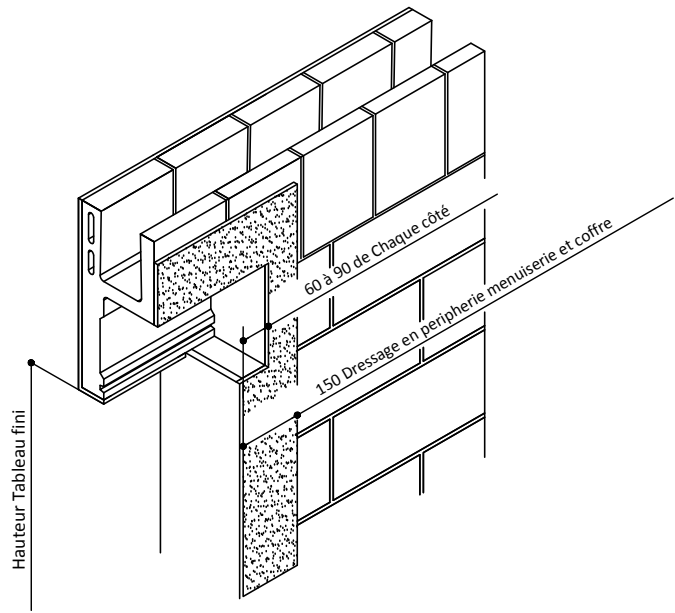
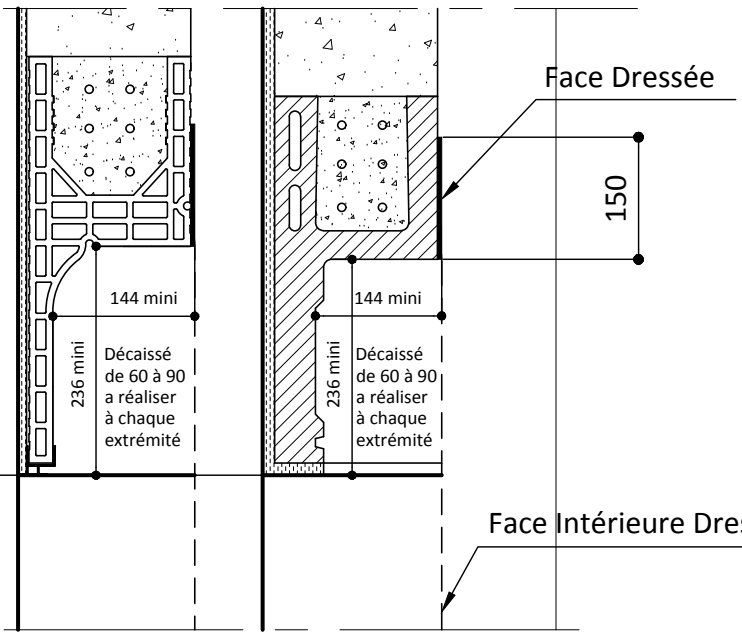

REPÈRE	TABLEAU FINI		SENS D'OUVERTURE	QTE
	HAUTEUR	LARGEUR		



ATTENTION! UTILISER UN TYPE DE DEMI-COFFRE PRÉCONISÉ PAR NOTRE B.E

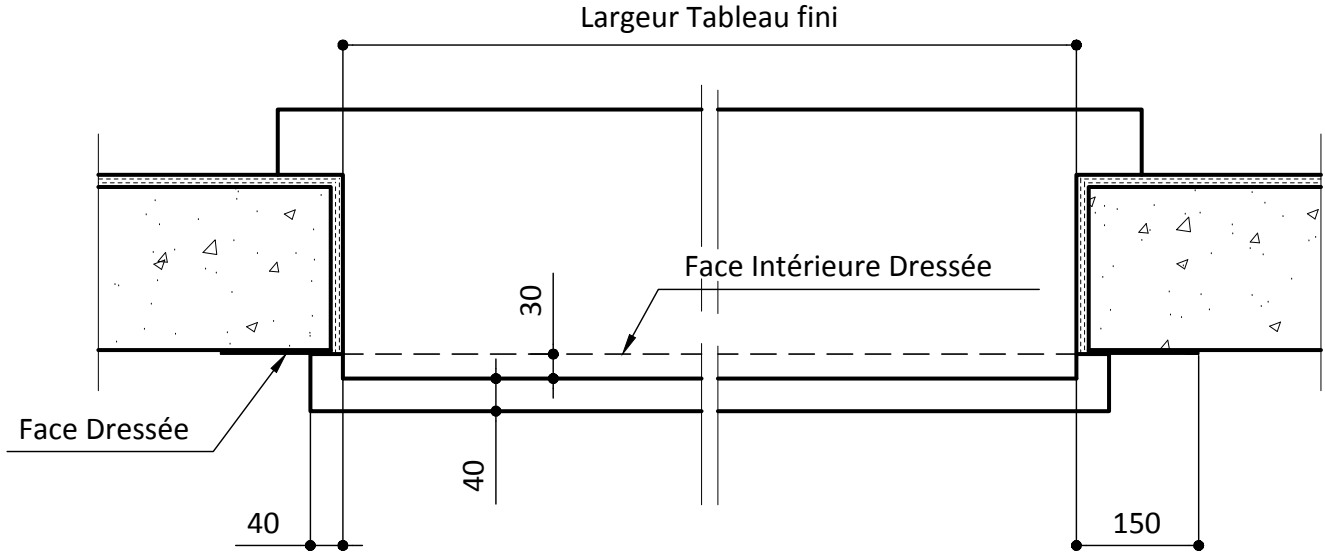
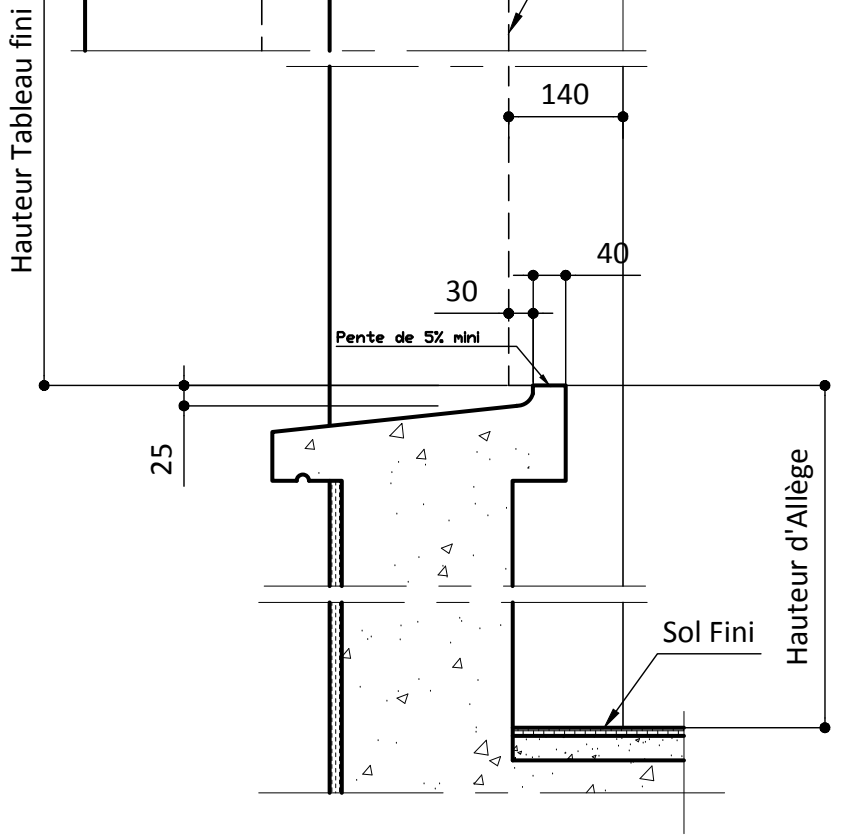

Désignation du plan :
 FRAPPE SUR ALLEGE - POSE 1D140
 VR OPTIBAIÉ (pose dans demi-linteau)
 Fichier : ResaCAIB_Pvc_P1.dwg
 Des. : M.CHAUVIERE Ech : 1 / 10 V9
 Date : 09/01/2018 N° : 10371

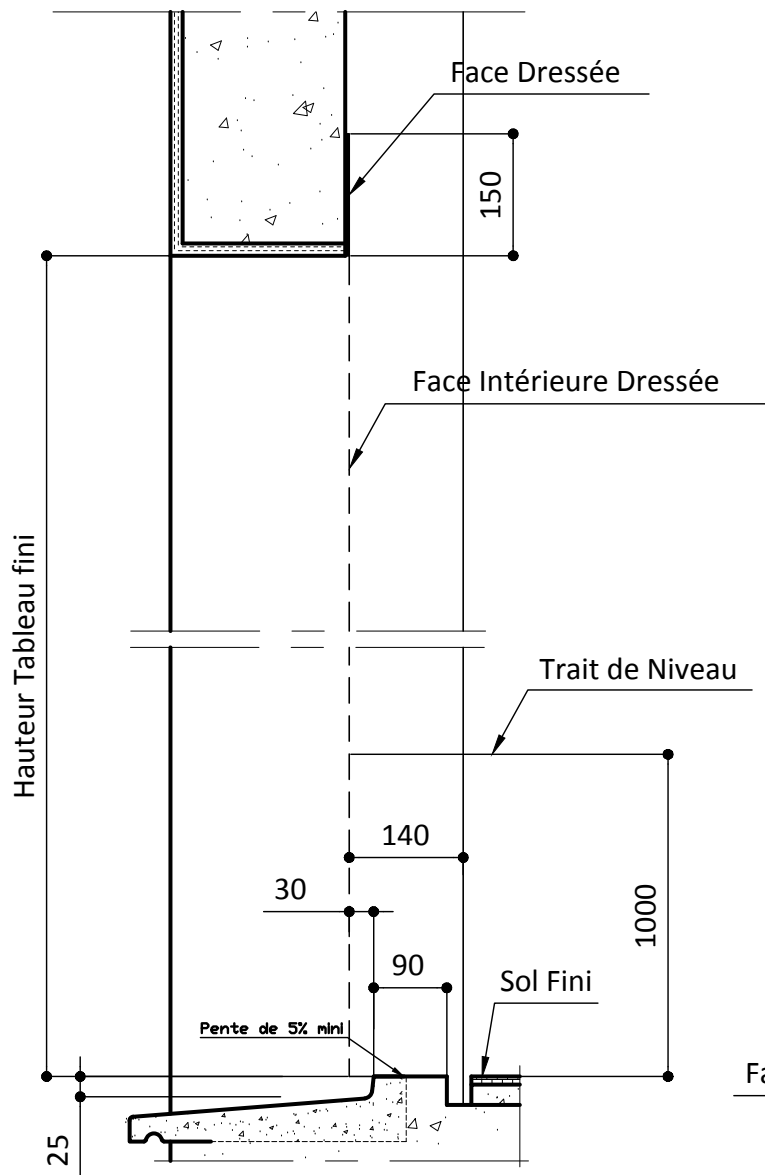

SEUIL STANDARD

REPÈRE	TABLEAU FINI		SENS D'OUVERTURE	VITRAGE EXT / INT	OBSERVATIONS	QTE
	HAUTEUR	LARGEUR				

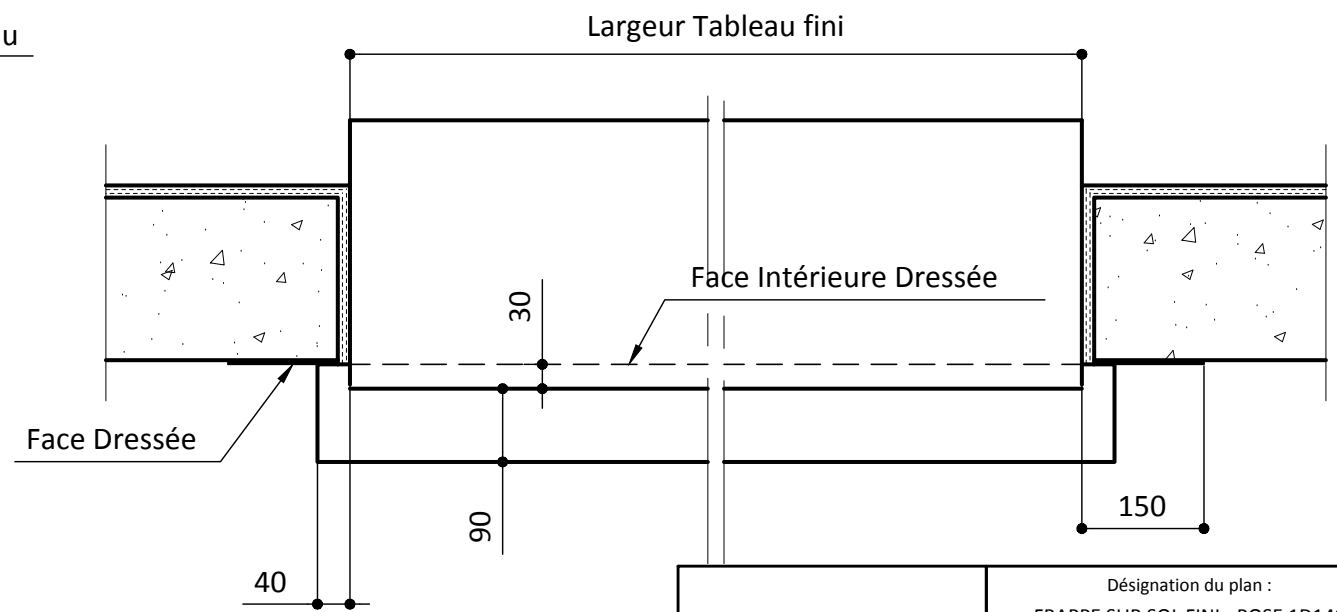

Désignation du plan :
 FRAPPE SUR SOL FINI - POSE 1D140
 SANS VR - VR EVIBAIE - VR TRADITIONNEL
 Fichier : ResaCAIB_Pvc_P1.dwg
 Des. : M.CHAUVIERE Ech : 1 / 10 W9
 Date : 09/01/2018 N° : 10376

REPÈRE	TABLEAU FINI		SENS D'OUVERTURE	VITRAGE EXT / INT	OBSERVATIONS	QTE
	HAUTEUR	LARGEUR				

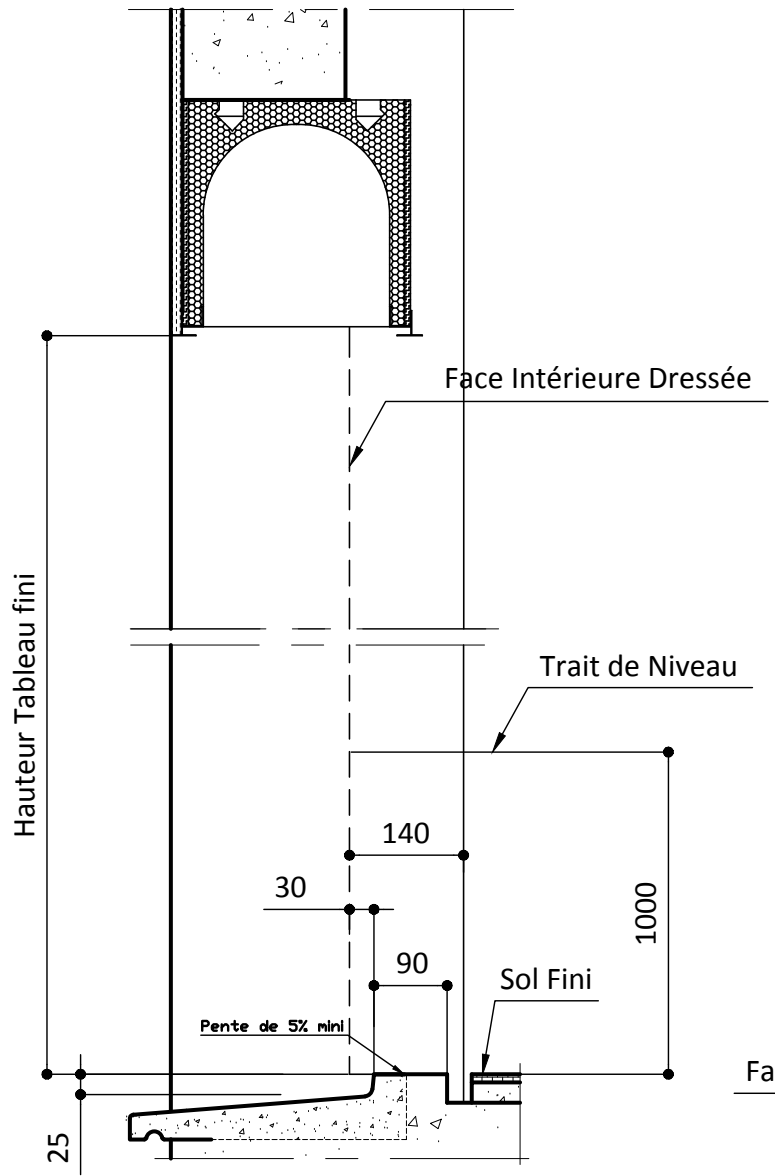

SEUIL STANDARD

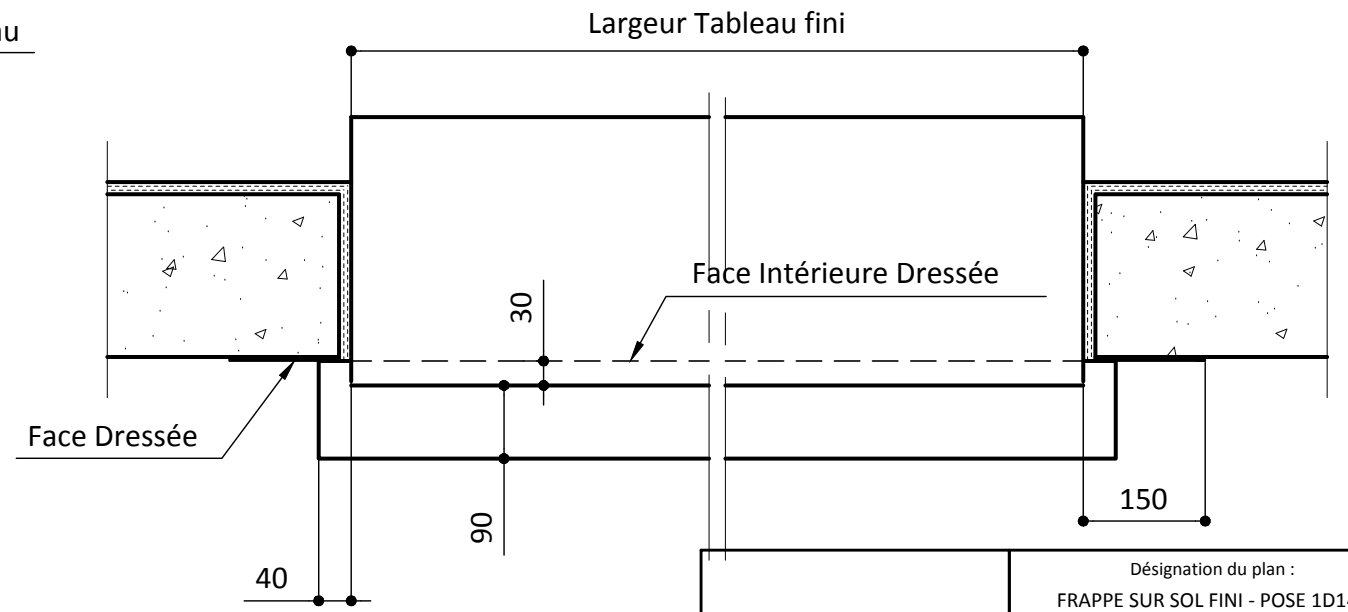

Désignation du plan :
FRAPPE SUR SOL FINI - POSE 1D140
VR PREFE (enroulement ext. et int.)

Fichier : ResaCAIB_Pvc_P1.dwg

Des. : M.CHAUVIERE Ech : 1 / 10 X9
Date : 09/01/2018 N° : 10381

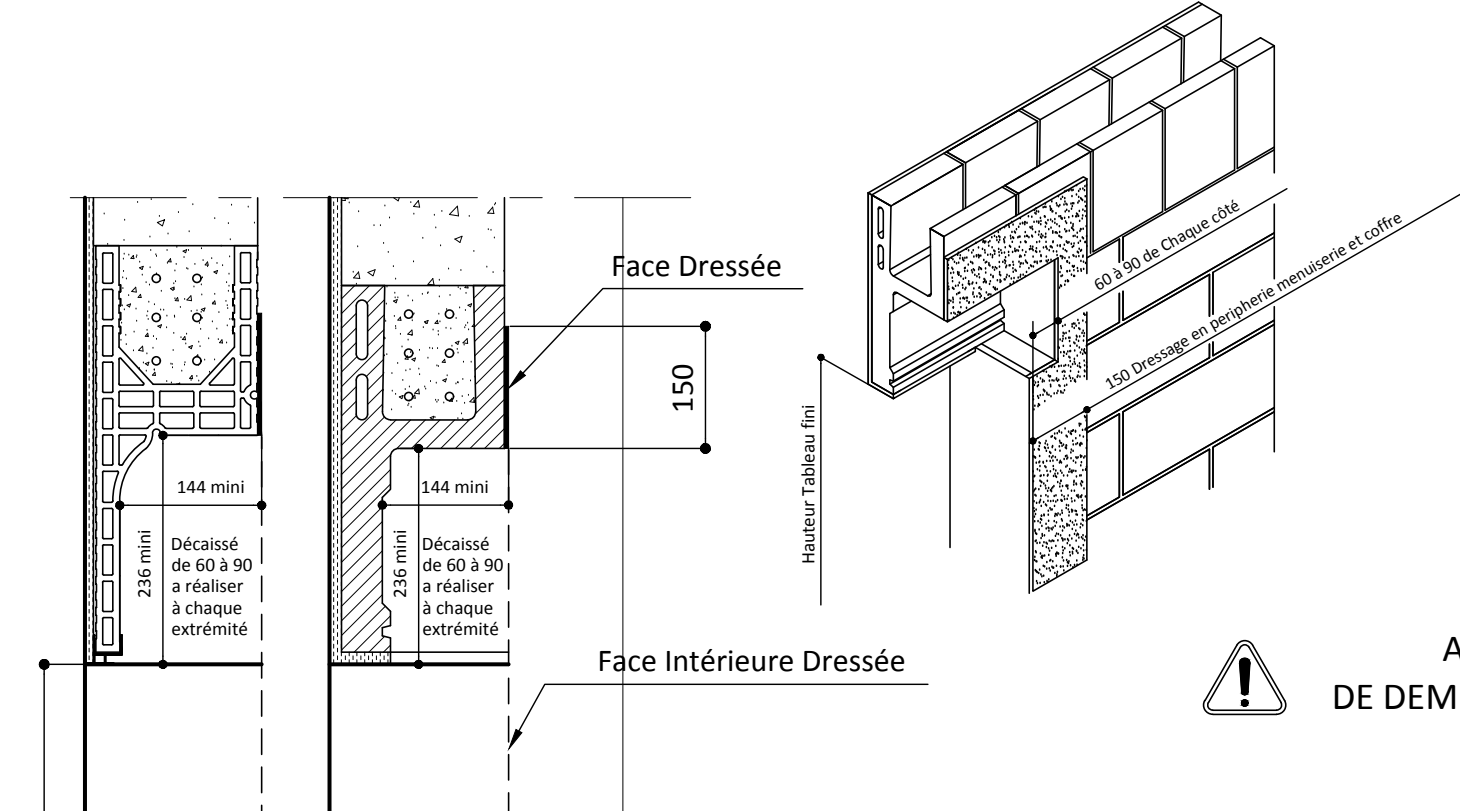

REPÈRE	TABLEAU FINI		SENS D'OUVERTURE	QTE
	HAUTEUR	LARGEUR		



ATTENTION! UTILISER UN TYPE DE DEMI-COFFRE PRÉCONISÉ PAR NOTRE B.E

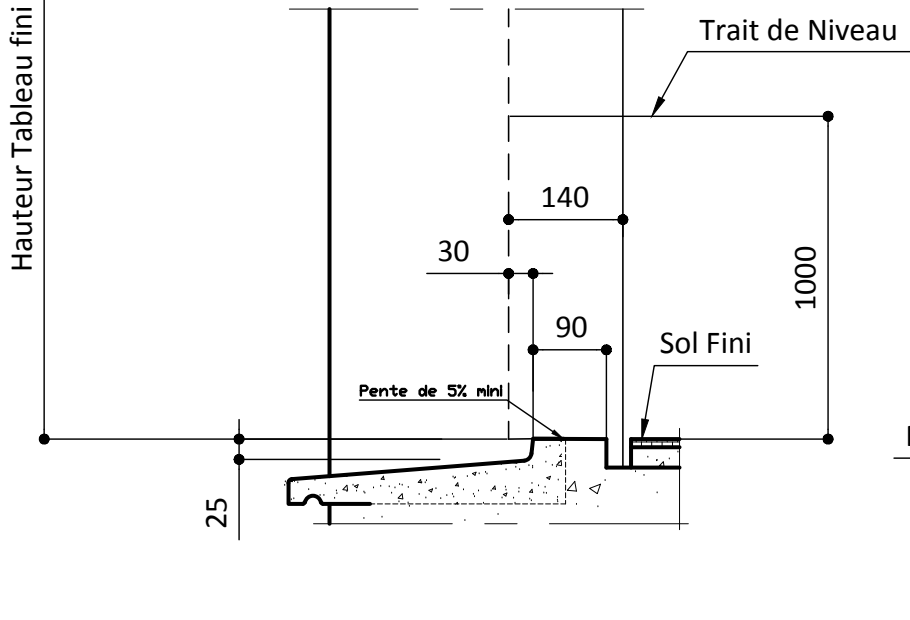

SEUIL STANDARD

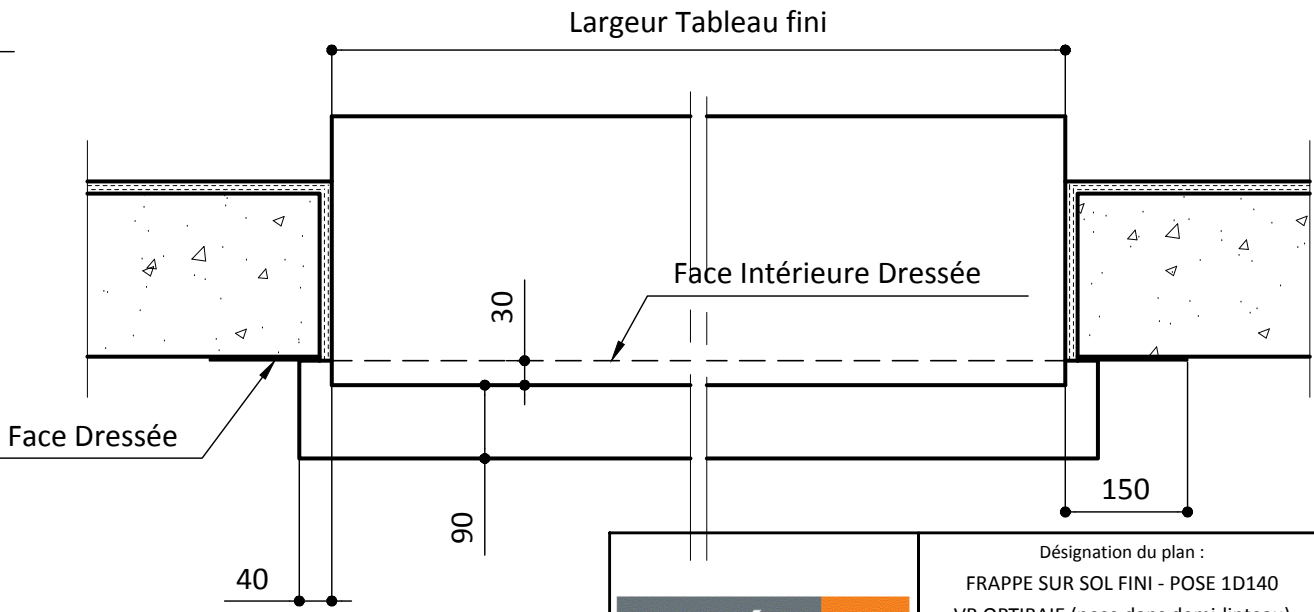

Désignation du plan : FRAPPE SUR SOL FINI - POSE 1D140 VR OPTIBAIÉ (pose dans demi-linteau)		
Fichier : ResaCAIB_Pvc_P1.dwg		
Des. : M.CHAUVIERE	Ech : 1 / 10	Y9
Date : 09/01/2018	N° :	10386

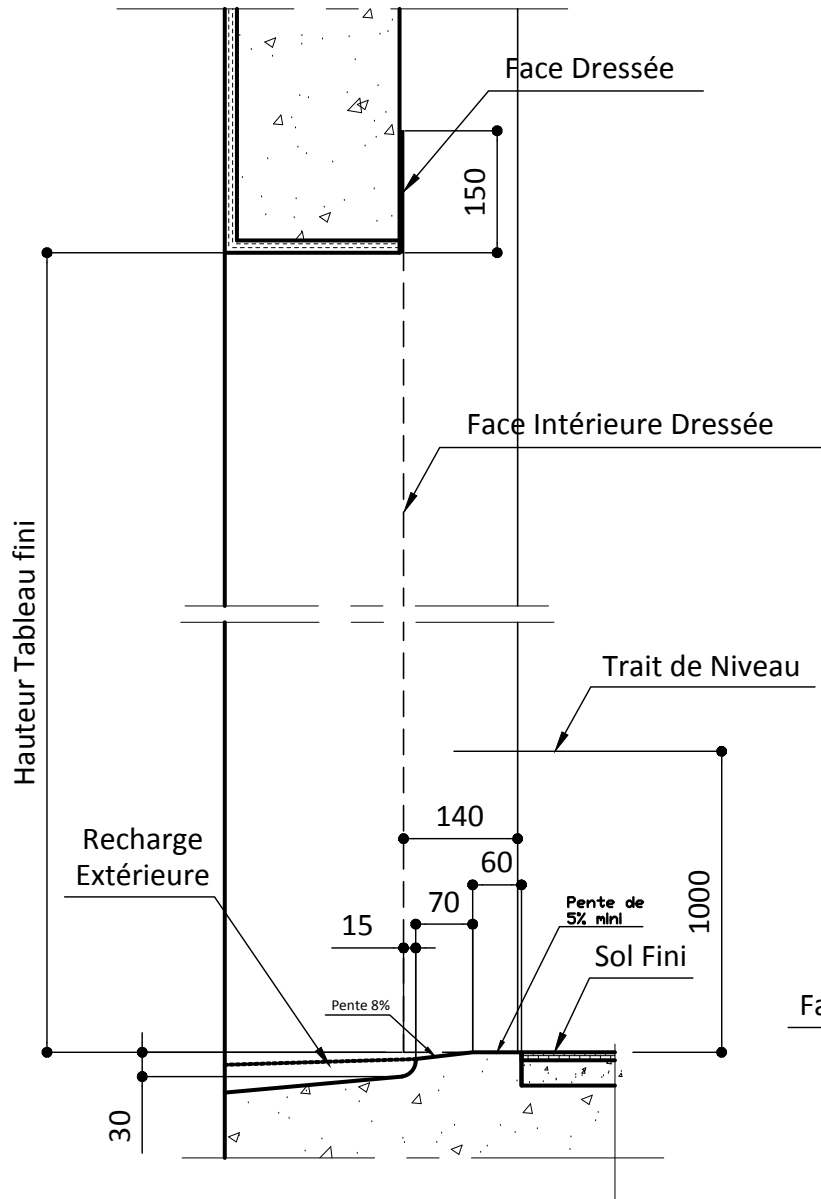

SEUIL PMR

REPÈRE	TABLEAU FINI		SENS D'OUVERTURE	VITRAGE EXT / INT	OBSERVATIONS	QTE
	HAUTEUR	LARGEUR				

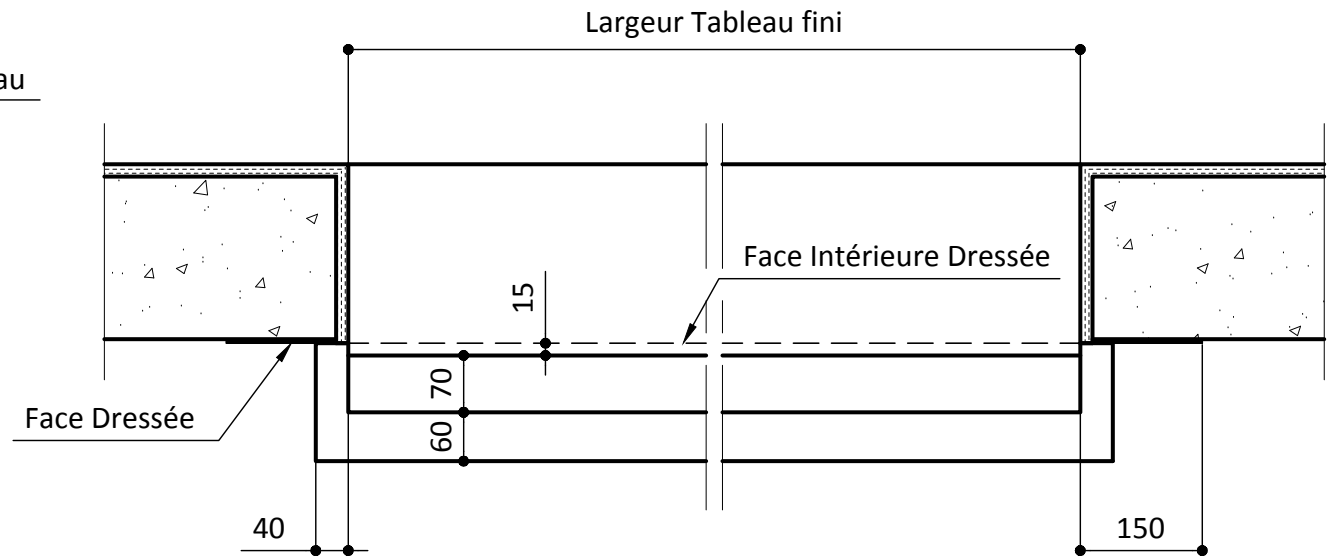

Désignation du plan :
 FRAPPE SEUIL PMR - POSE 1D140
 VR EVIBAIE - VR TRADITIONNEL

Fichier : ResaCAIB_Pvc_P1.dwg

Des. : M.CHAUVIERE Ech : 1 / 10 BB9

Date : 09/01/2018 N° : 10401

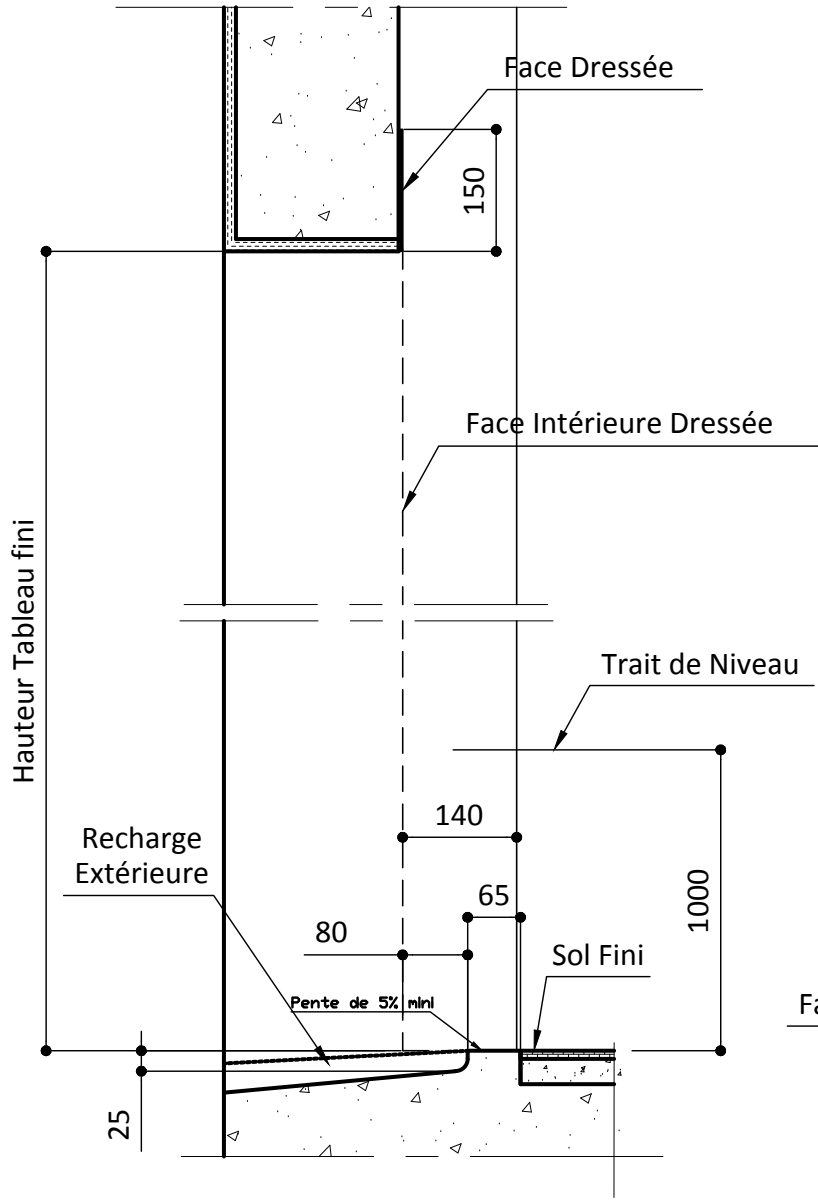

SEUIL PMR

REPÈRE	TABLEAU FINI		SENS D'OUVERTURE	VITRAGE EXT / INT	OBSERVATIONS	QTE
	HAUTEUR	LARGEUR				

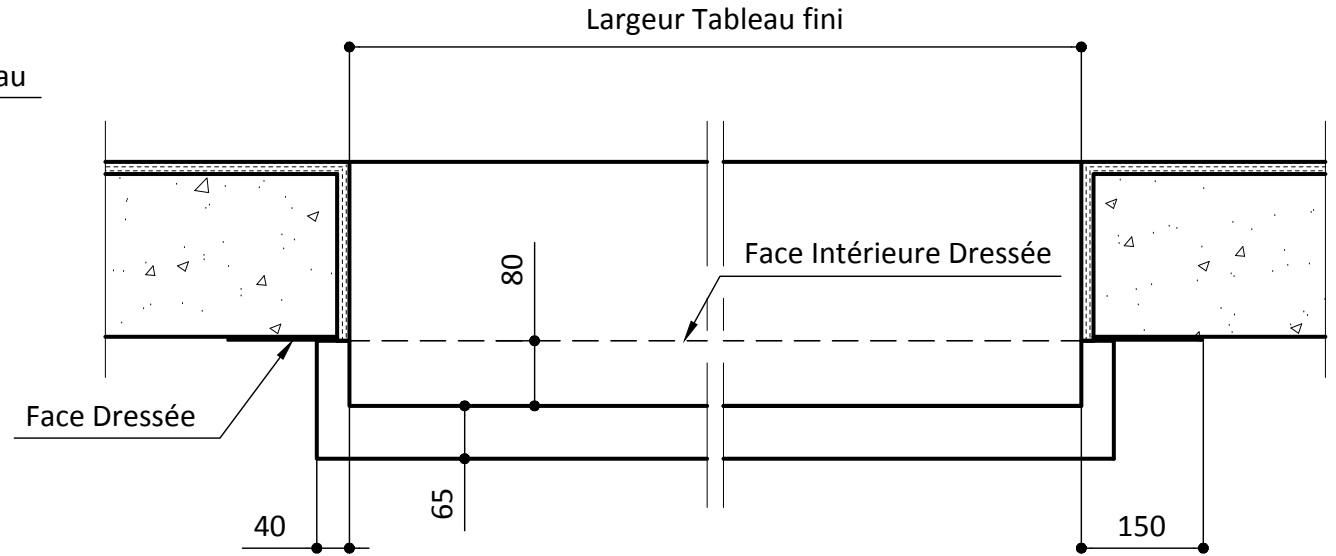

Désignation du plan :
 FRAPPE SEUIL PMR - POSE 1D140
 SANS VR

Fichier : ResaCAIB_Pvc_P1.dwg

Des. : M.CHAUVIERE Ech : 1 / 10 CC9

Date : 09/01/2018 N° : 10406

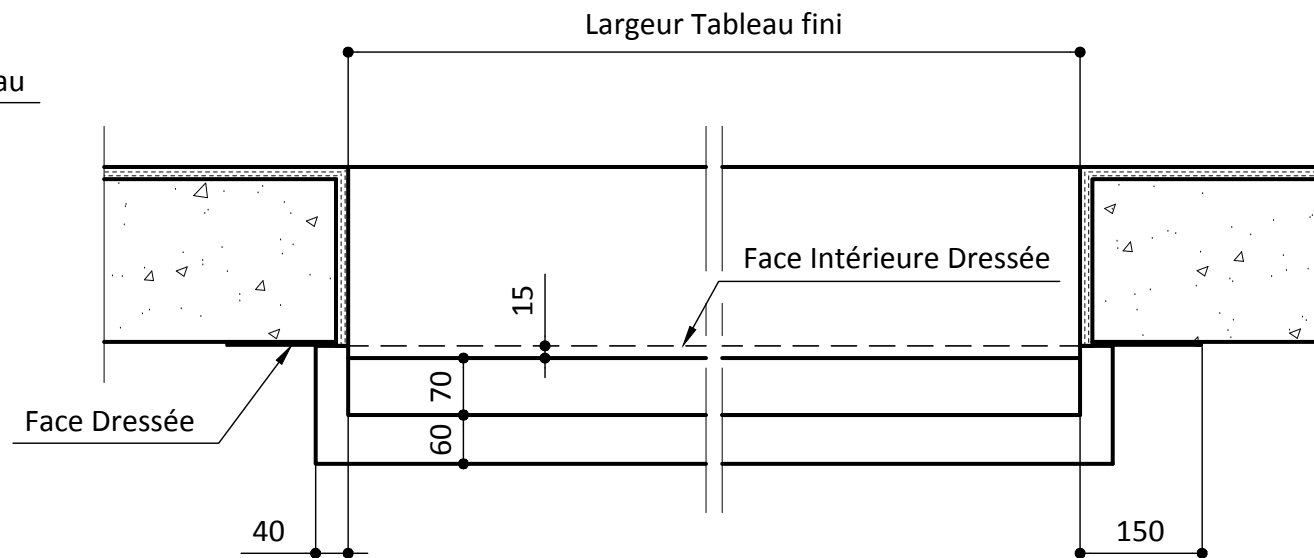
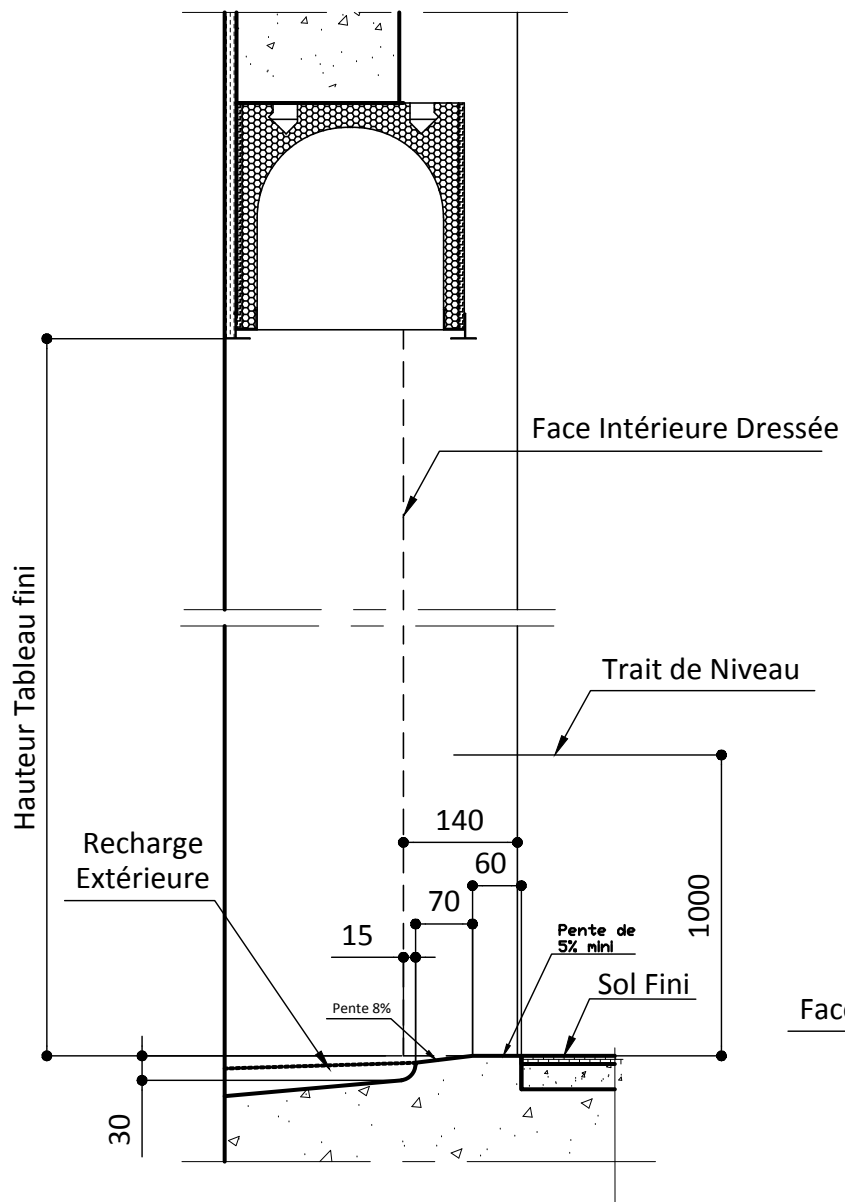

REPERE	TABLEAU FINI		SENS D'OUVERTURE	VITRAGE EXT / INT	OBSERVATIONS	QTE
	HAUTEUR	LARGEUR				



Désignation du plan :
 FRAPPE SEUIL PMR - POSE 1D140
 VR PREFA (enroulement ext. et int.)

Fichier : ResaCAIB_Pvc_P1.dwg

Des. : M.CHAUVIERE Ech : 1 / 10 DD9

Date : 09/01/2018 N° : 10411

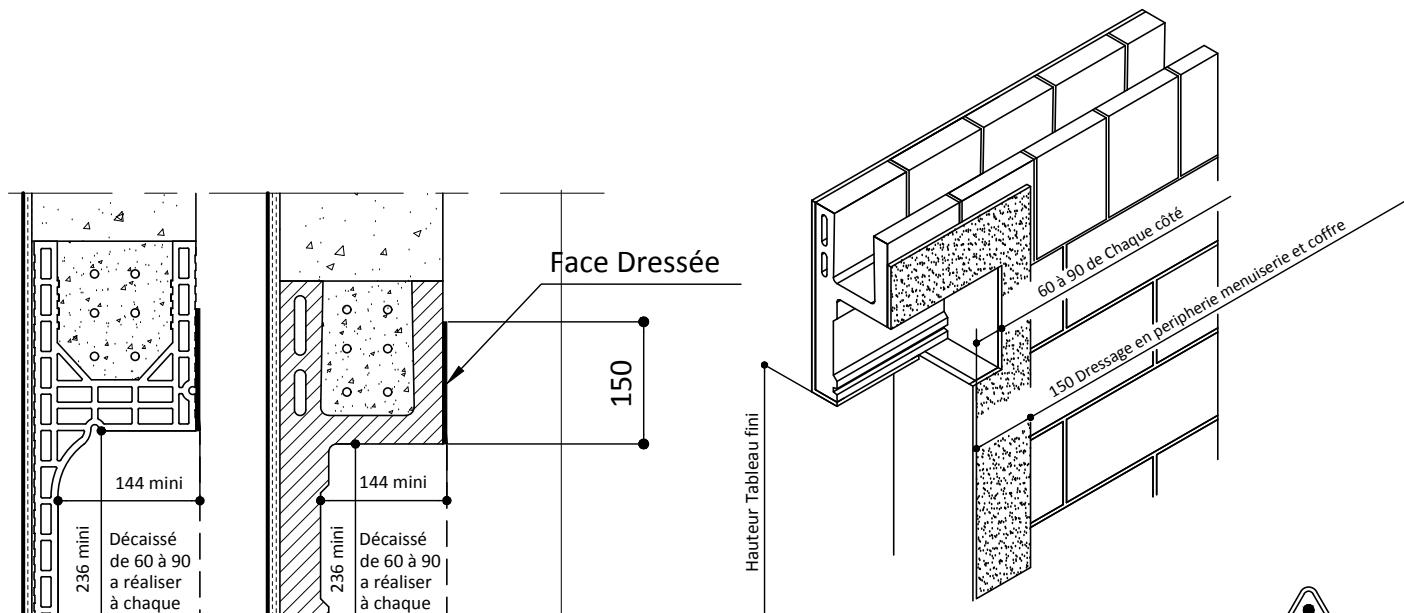

REPÈRE	TABLEAU FINI		SENS D'OUVERTURE	QTE
	HAUTEUR	LARGEUR		

ATTENTION! UTILISER UN TYPE DE DEMI-COFFRE PRÉCONISÉ PAR NOTRE B.E

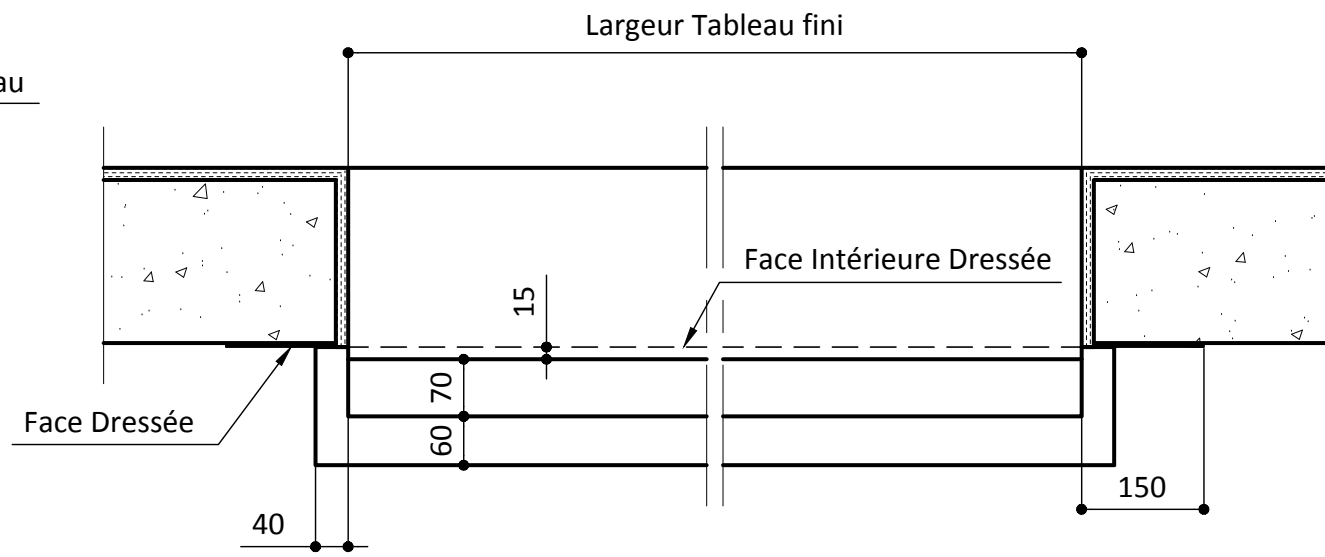
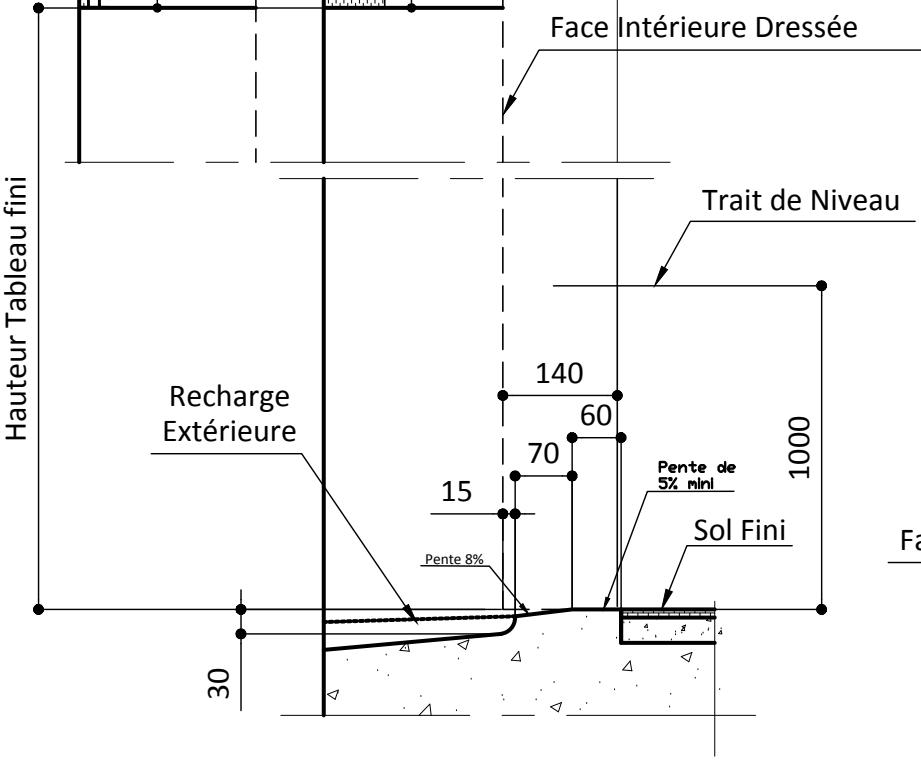

Désignation du plan : FRAPPE SEUIL PMR - POSE 1D140 VR OPTIBAIE (pose dans demi-linteau)		
Fichier : ResaCAIB_Pvc_P1.dwg		
Des. : M.CHAUVIERE	Ech : 1 / 10	EE9
Date : 09/01/2018	N° :	10416

RESERVATIONS MAÇONNERIE
SI SEUILS ELARGIS en DOUBLAGE de 140mm

POSITIONNER L'APPUI MAÇONNERIE EN FONCTION DU SEUIL CHOISI

SUR ALLEGE
MAÇONNERIE

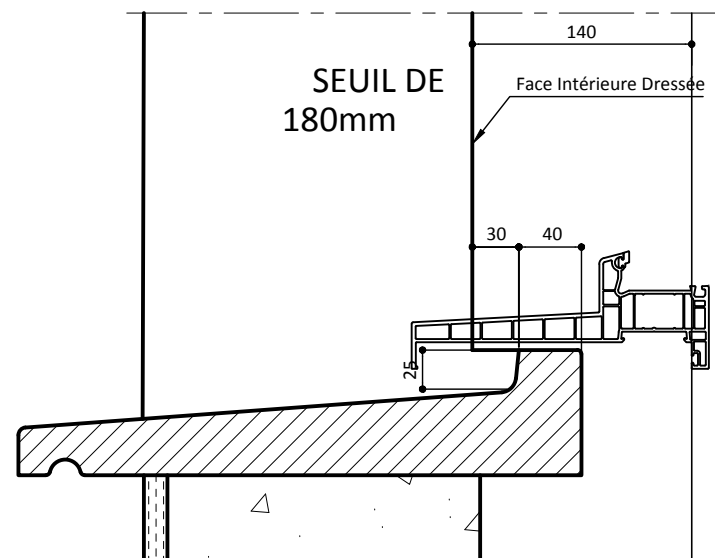
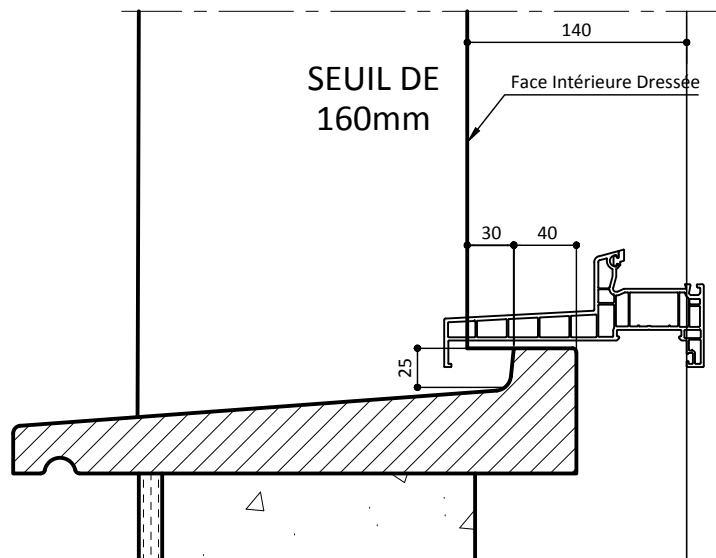

SUR SOL FINI

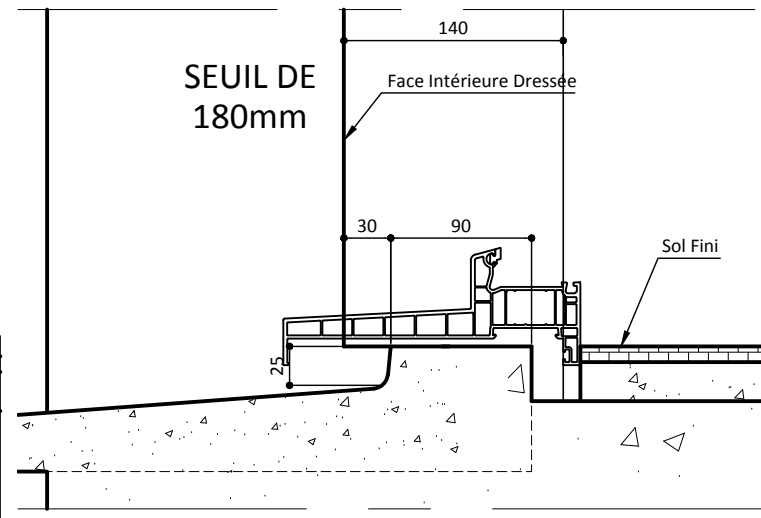
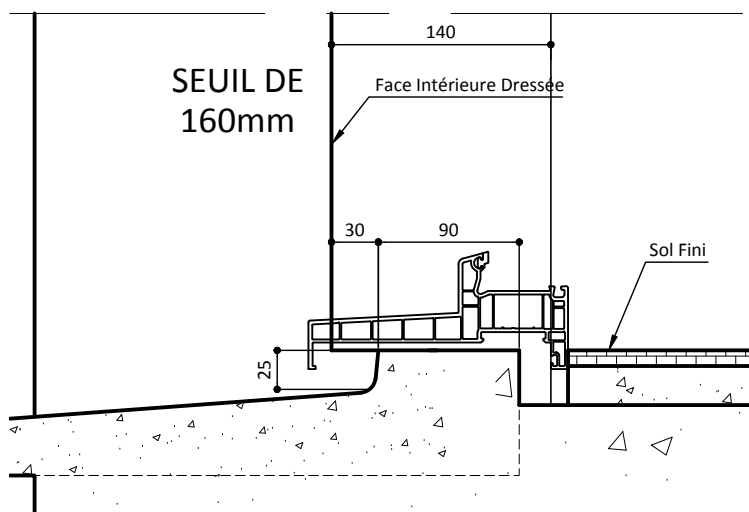

Désignation du plan :
FRAPPE SEUIL ELARGI - POSE 1D140
SUR ALLEGE ET SOL FINI

Fichier : ResaCAIB_Pvc_P1.dwg

Des. : M.CHAUVIERE

Ech : 1 / 5 I19

Date : 09/01/2018

N° : 10436

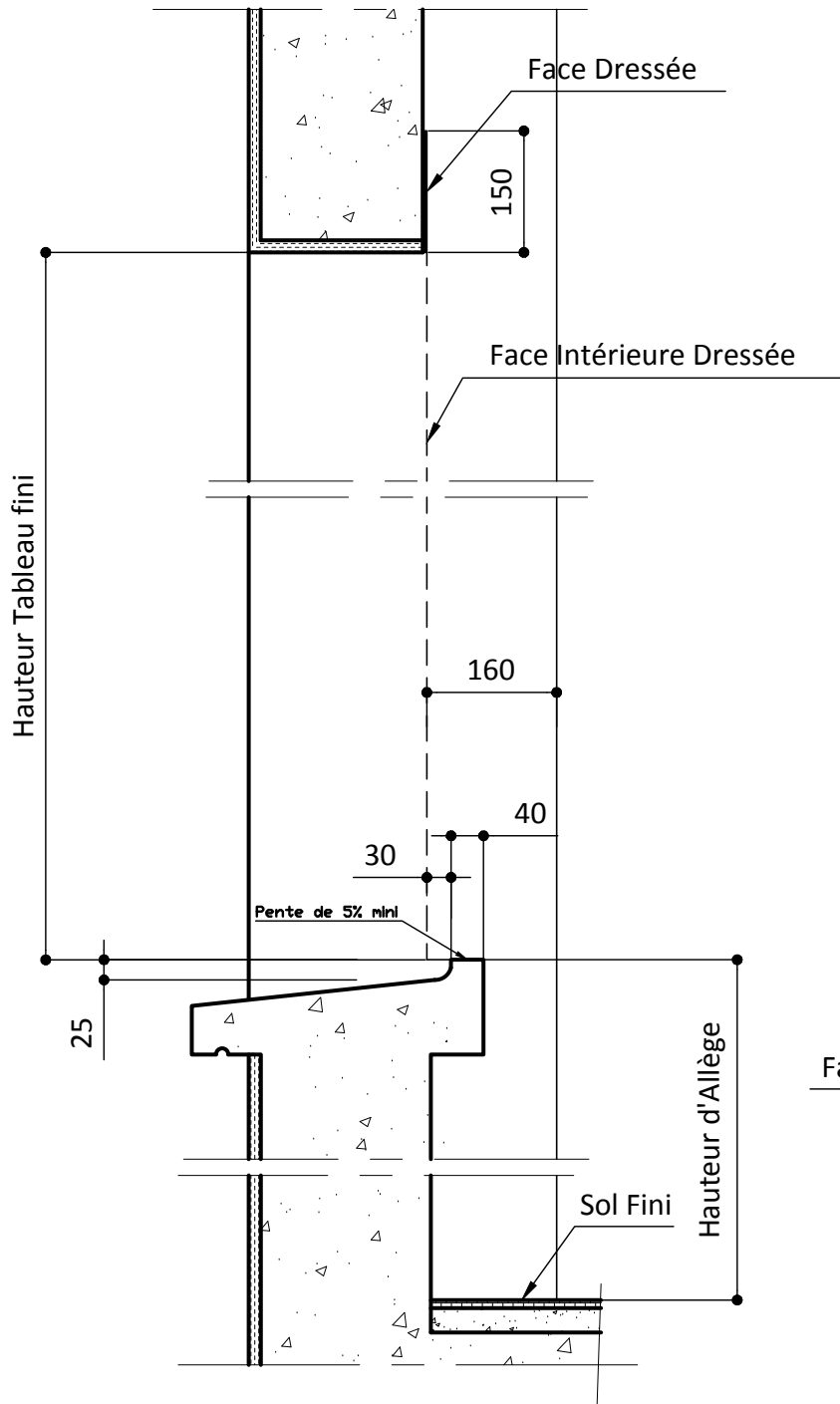

REPERE	TABLEAU FINI		SENS D'OUVERTURE	VITRAGE EXT / INT	OBSERVATIONS	QTE
	HAUTEUR	LARGEUR				

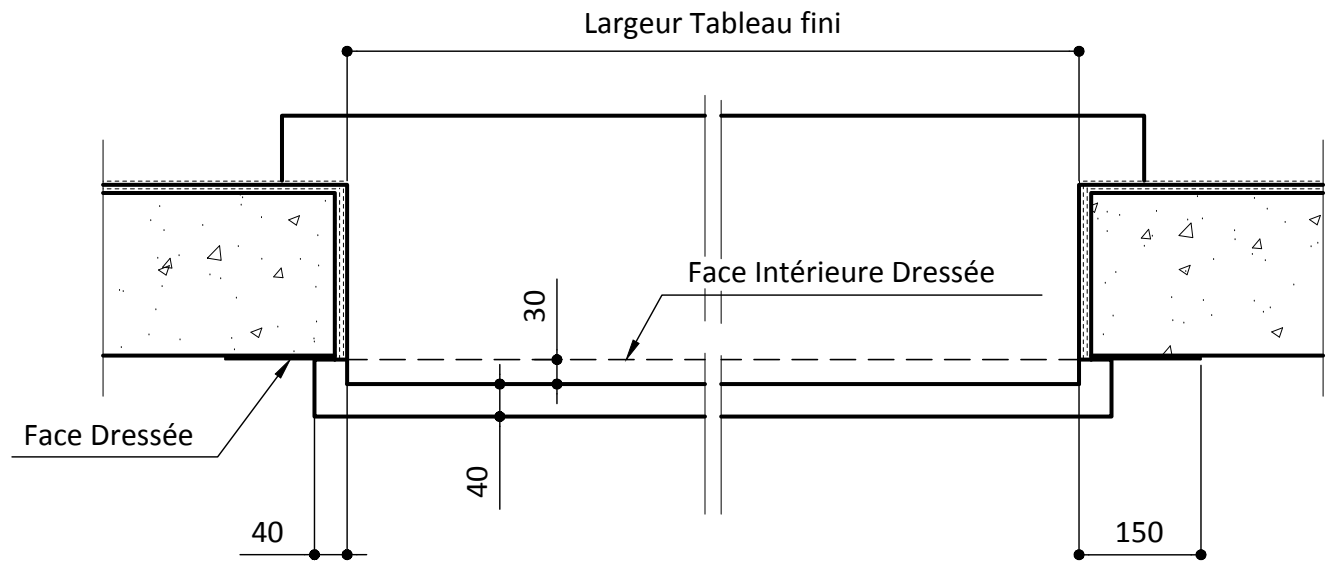

Désignation du plan :
 FRAPPE SUR ALLEGE - POSE 1D160
 SANS VR - VR EVIBAIE - VR TRADITIONNEL
 Fichier : ResaCAIB_Pvc_P1.dwg
 Des. : M.CHAUVIERE Ech : 1 / 10 T10
 Date : 09/01/2018 N° : 10451

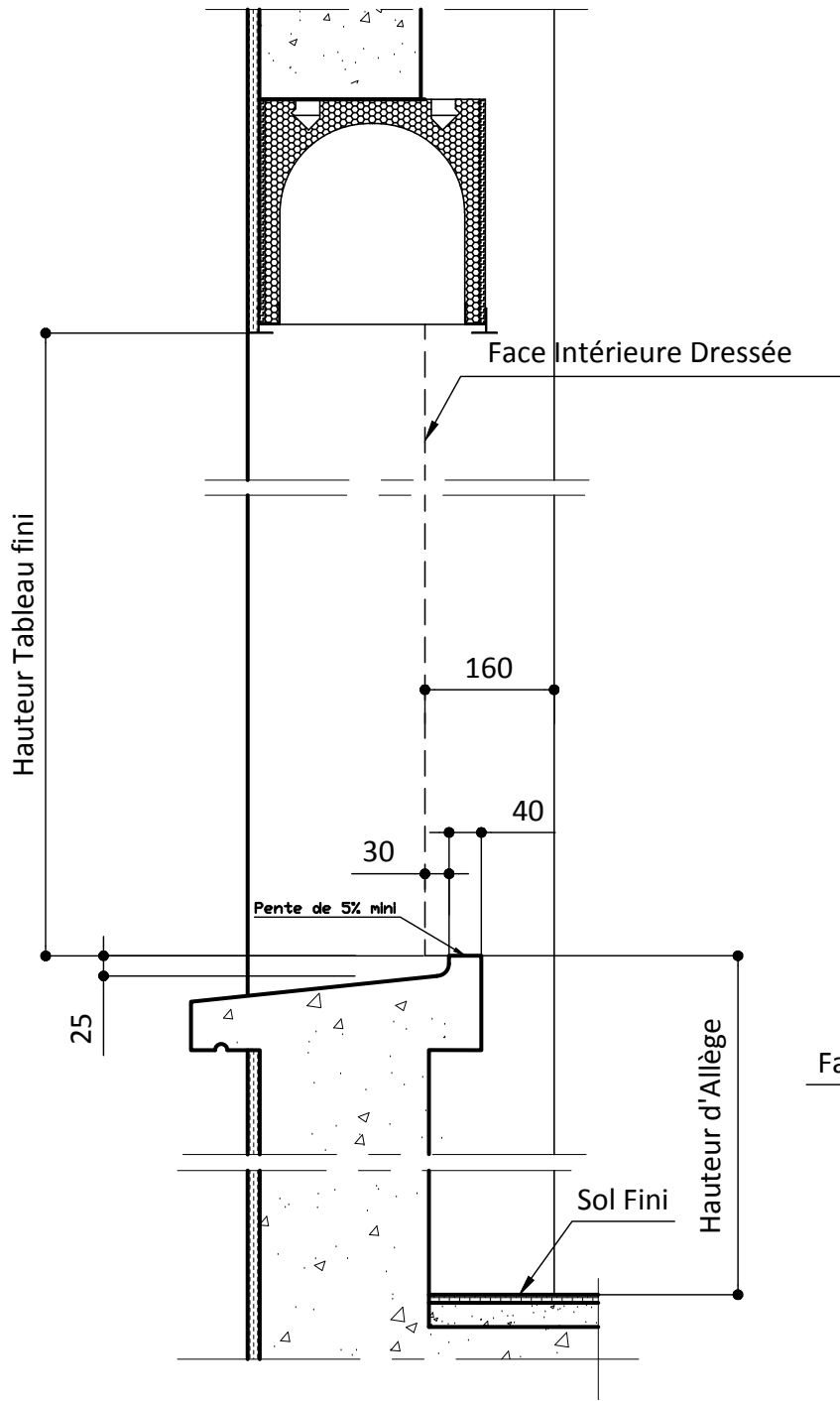

REPÈRE	TABLEAU FINI		SENS D'OUVERTURE	VITRAGE EXT / INT	OBSERVATIONS	QTE
	HAUTEUR	LARGEUR				

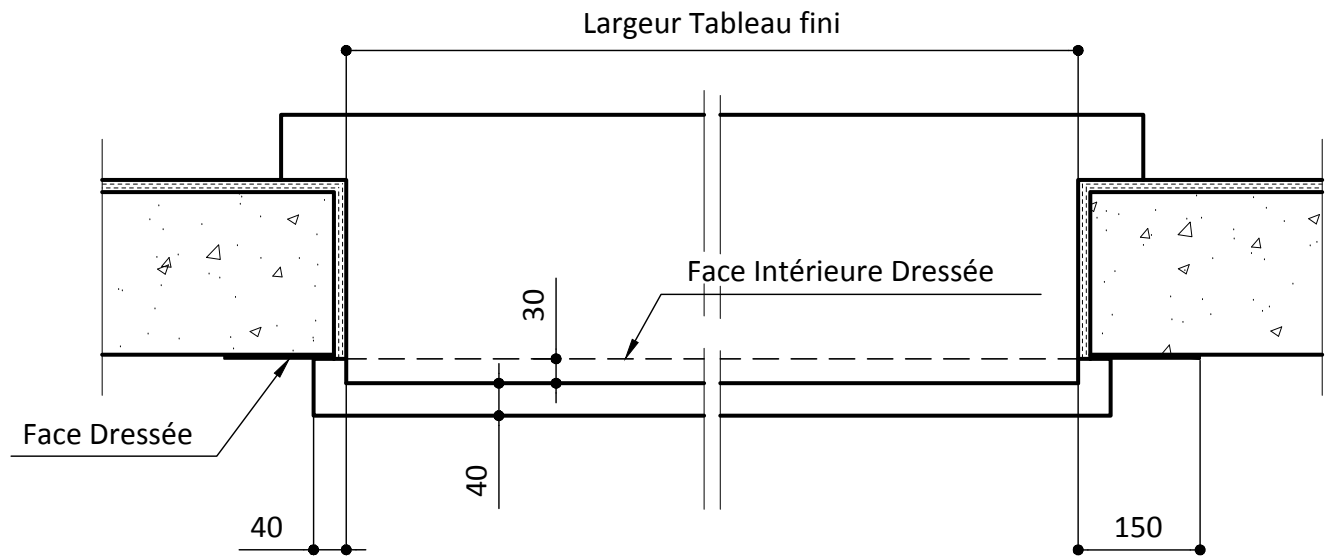

Désignation du plan :
 FRAPPE SUR ALLEGE - POSE 1D160
 VR PREFE (enroulement ext. et int.)

Fichier : ResaCAIB_Pvc_P1.dwg

Des. : M.CHAUVIERE Ech : 1 / 10 U10

Date : 09/01/2018 N° : 10456

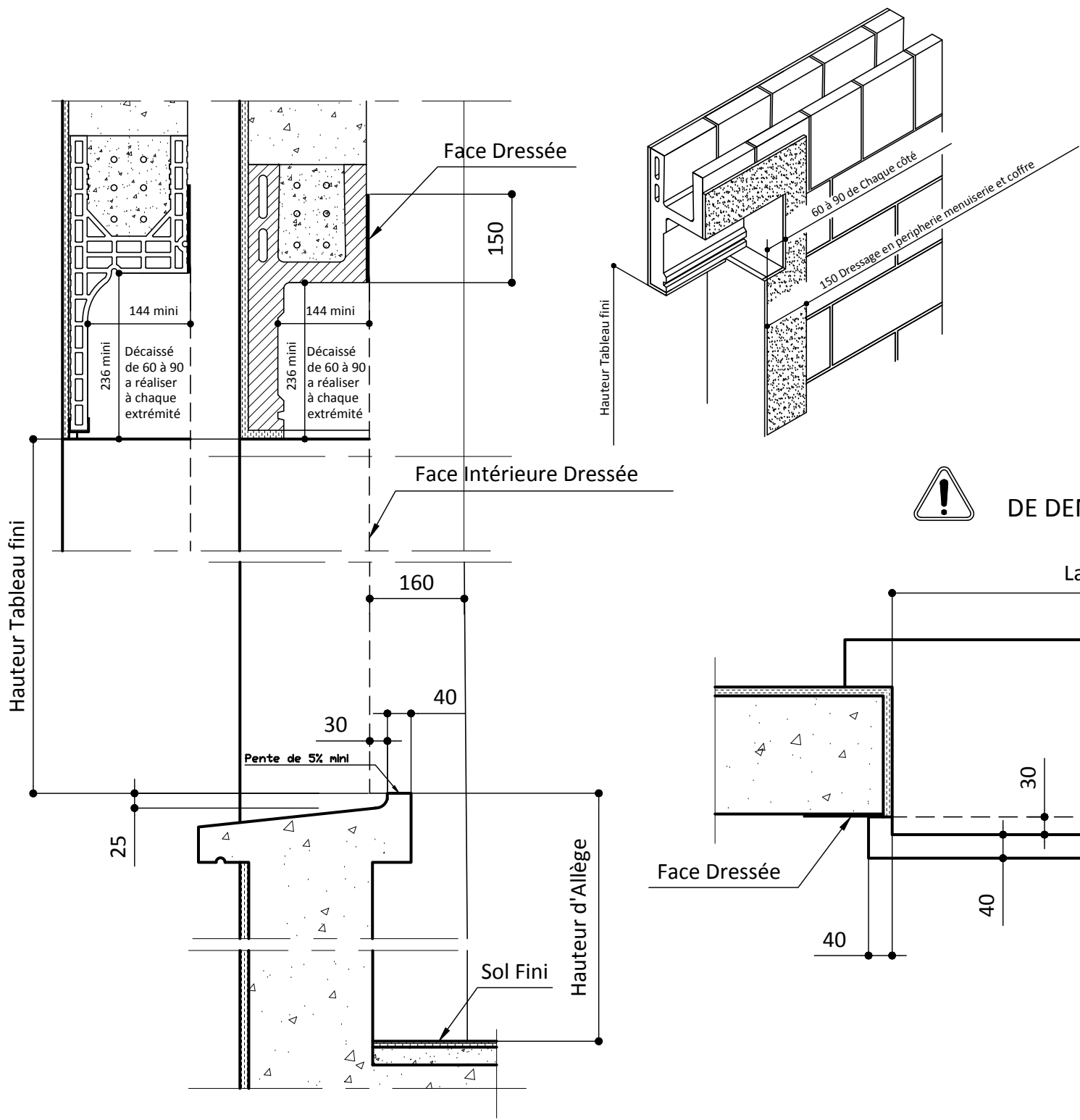

REPÈRE	TABLEAU FINI		SENS D'OUVERTURE	QTE
	HAUTEUR	LARGEUR		



ATTENTION! UTILISER UN TYPE DE DEMI-COFFRE PRÉCONISÉ PAR NOTRE B.E

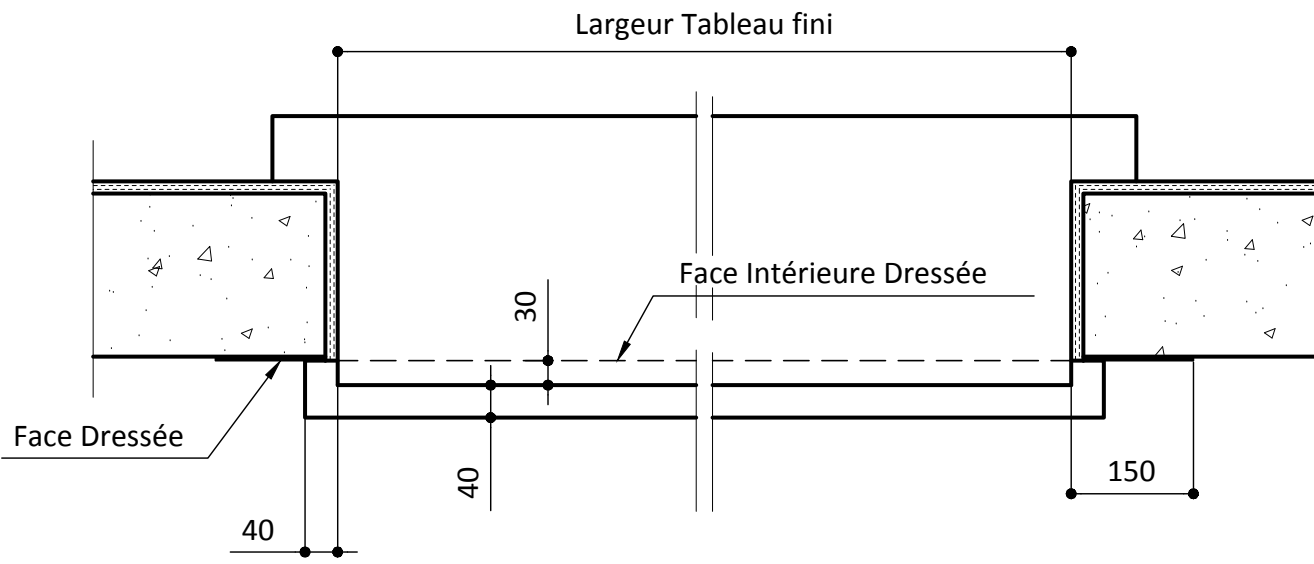

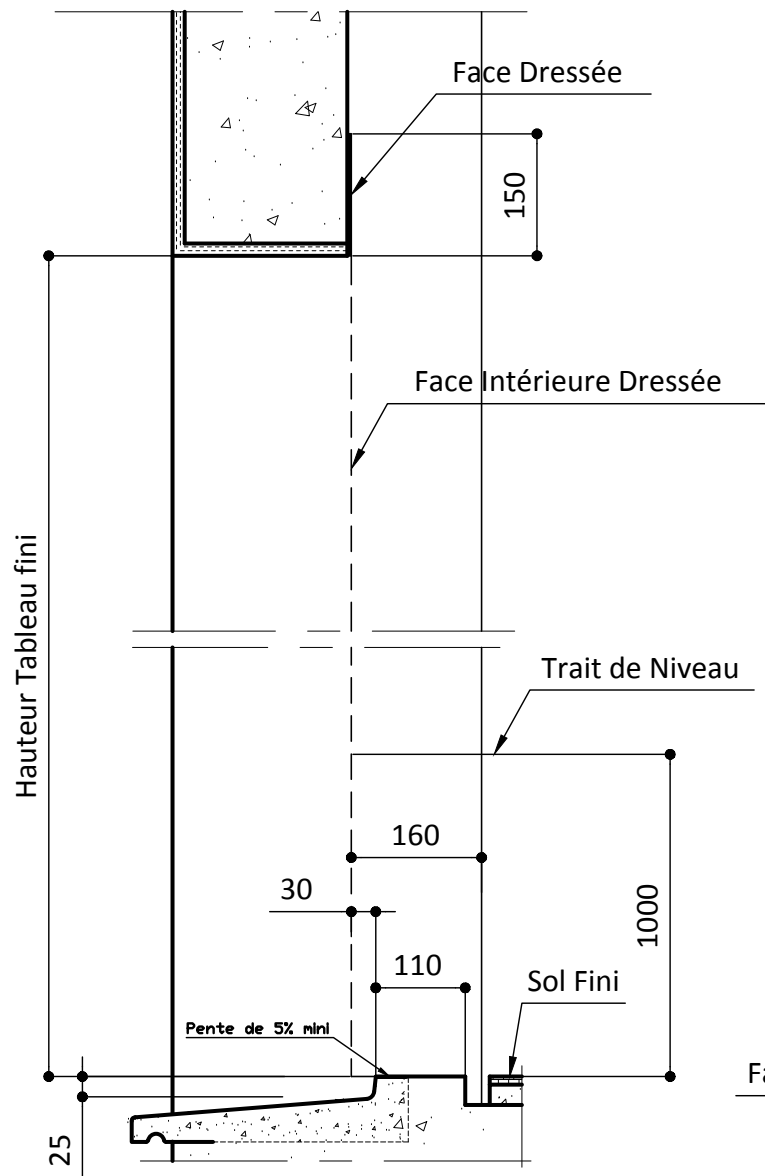

Désignation du plan :
 FRAPPE SUR ALLEGE - POSE 1D160
 VR OPTIBAIE (pose dans demi-linteau)
 Fichier : ResaCAIB_Pvc_P1.dwg
 Des. : M.CHAUVIERE Ech : 1 / 10 V10
 Date : 09/01/2018 N° : 10461

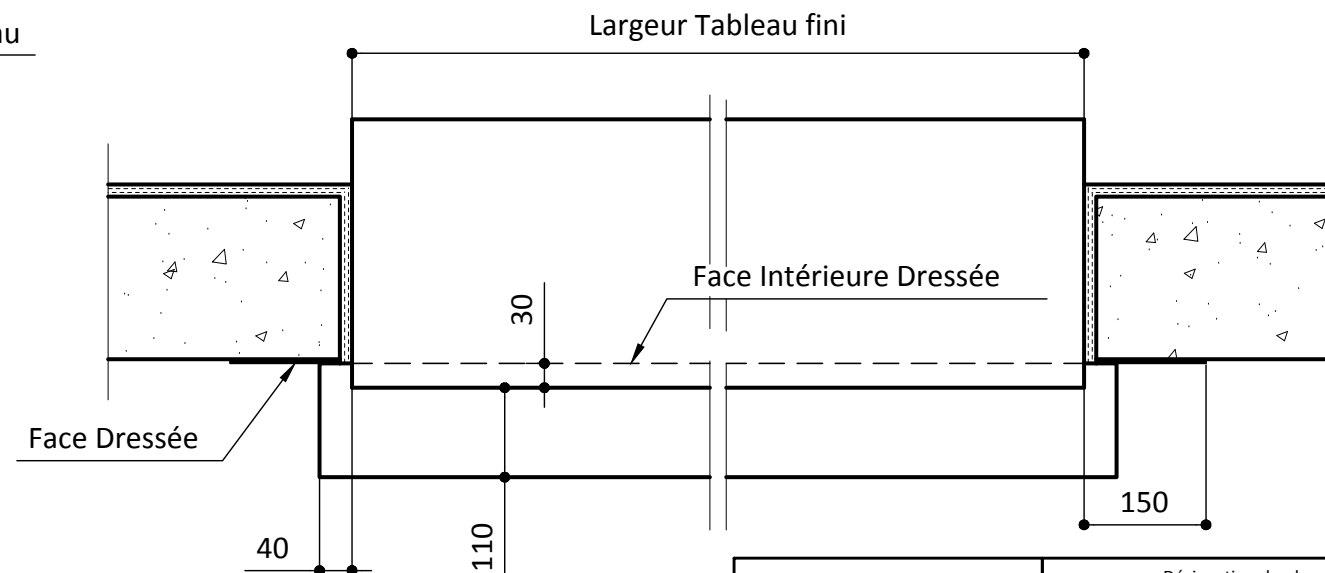

SEUIL STANDARD

REPÈRE	TABLEAU FINI		SENS D'OUVERTURE	VITRAGE EXT / INT	OBSERVATIONS	QTE
	HAUTEUR	LARGEUR				



 	Désignation du plan : FRAPPE SUR SOL FINI - POSE 1D160 SANS VR - VR EVIBAIE - VR TRADITIONNEL		
	Fichier : ResaCAIB_Pvc_P1.dwg		
Des. : M.CHAUVIERE	Ech : 1 / 10	W10	
Date : 09/01/2018	N° :	10466	

REPERE	TABLEAU FINI		SENS D'OUVERTURE	VITRAGE EXT / INT	OBSERVATIONS	QTE
	HAUTEUR	LARGEUR				

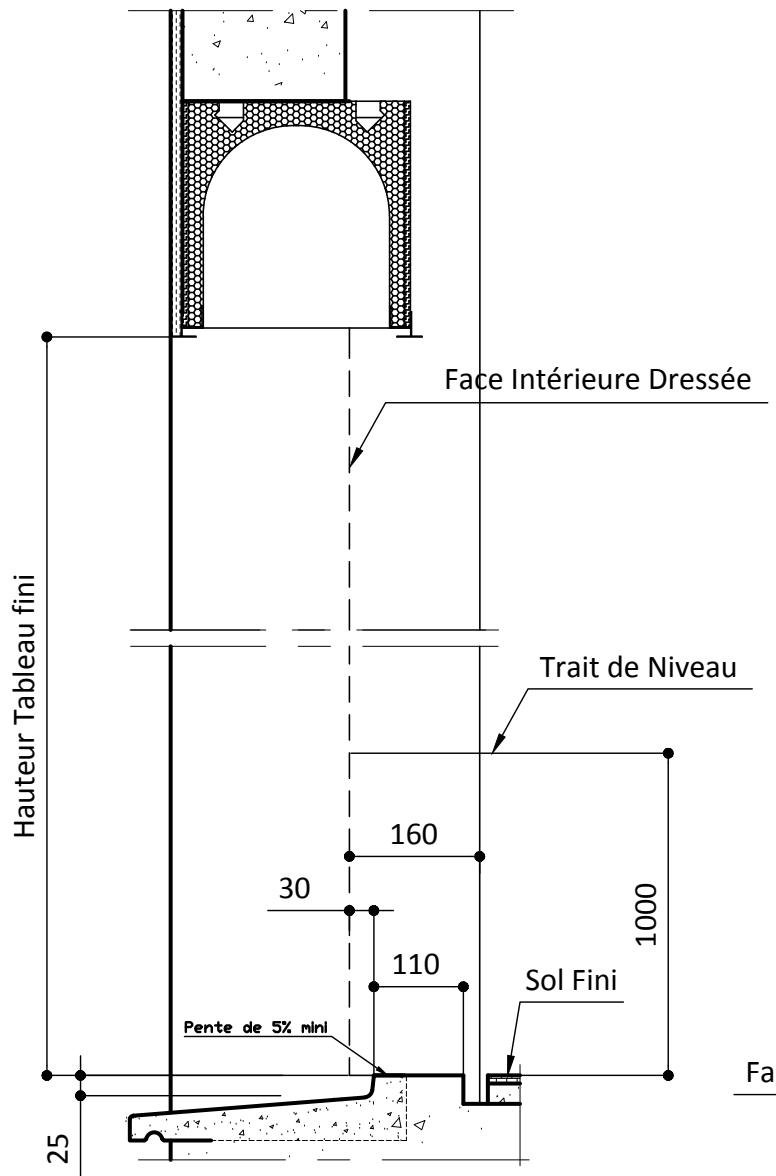

SEUIL STANDARD

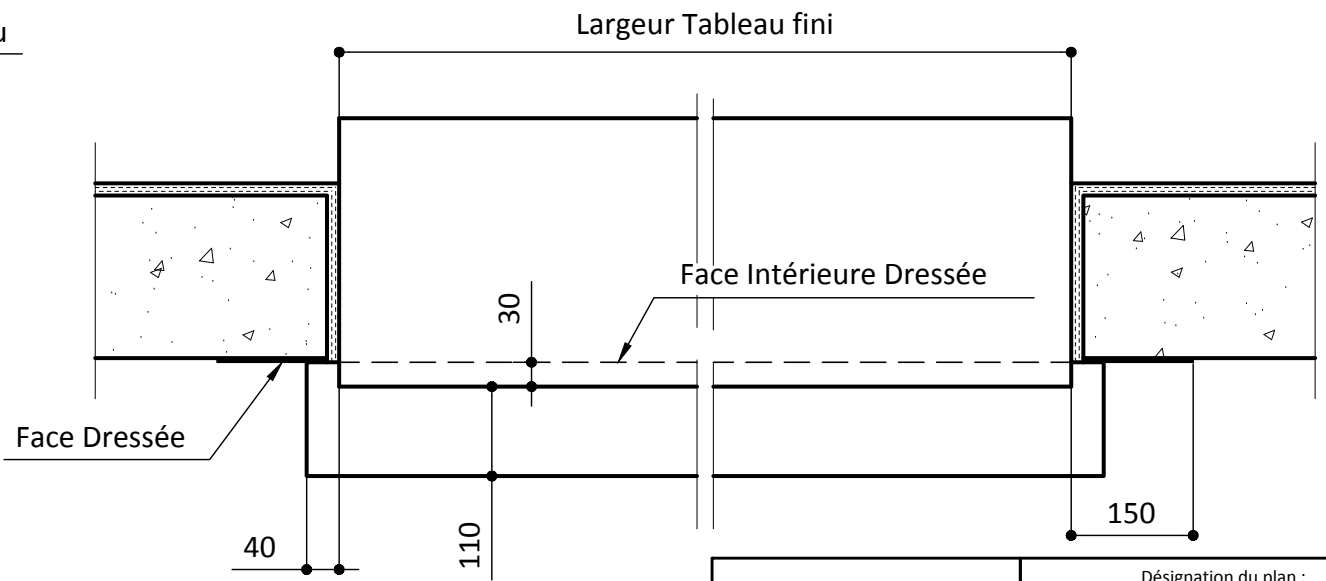

Désignation du plan :
 FRAPPE SUR SOL FINI - POSE 1D160
 VR PREFE (enroulement ext. et int.)
 Fichier : ResaCAIB_Pvc_P1.dwg
 Des. : M.CHAUVIERE Ech : 1 / 10 X10
 Date : 09/01/2018 N° : 10471

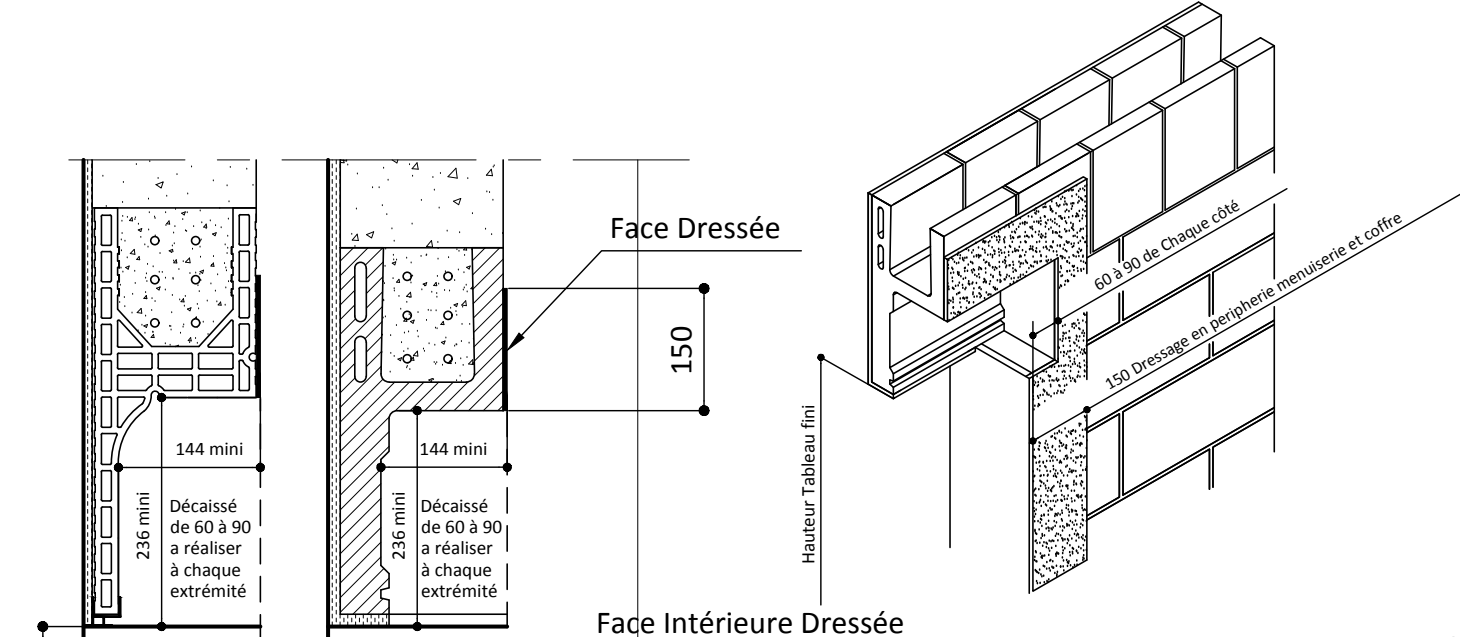

REPÈRE	TABLEAU FINI		SENS D'OUVERTURE	QTE
	HAUTEUR	LARGEUR		



ATTENTION! UTILISER UN TYPE DE DEMI-COFFRE PRÉCONISÉ PAR NOTRE B.E

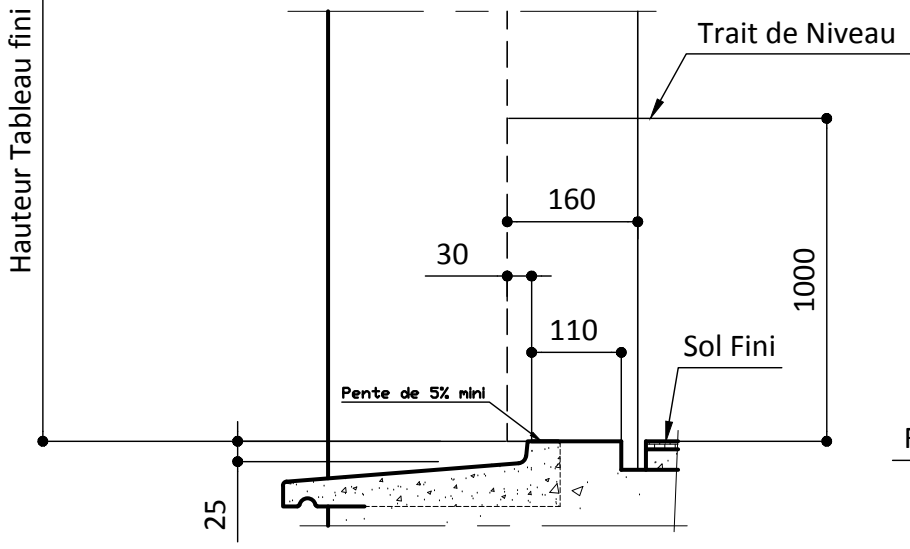

SEUIL STANDARD

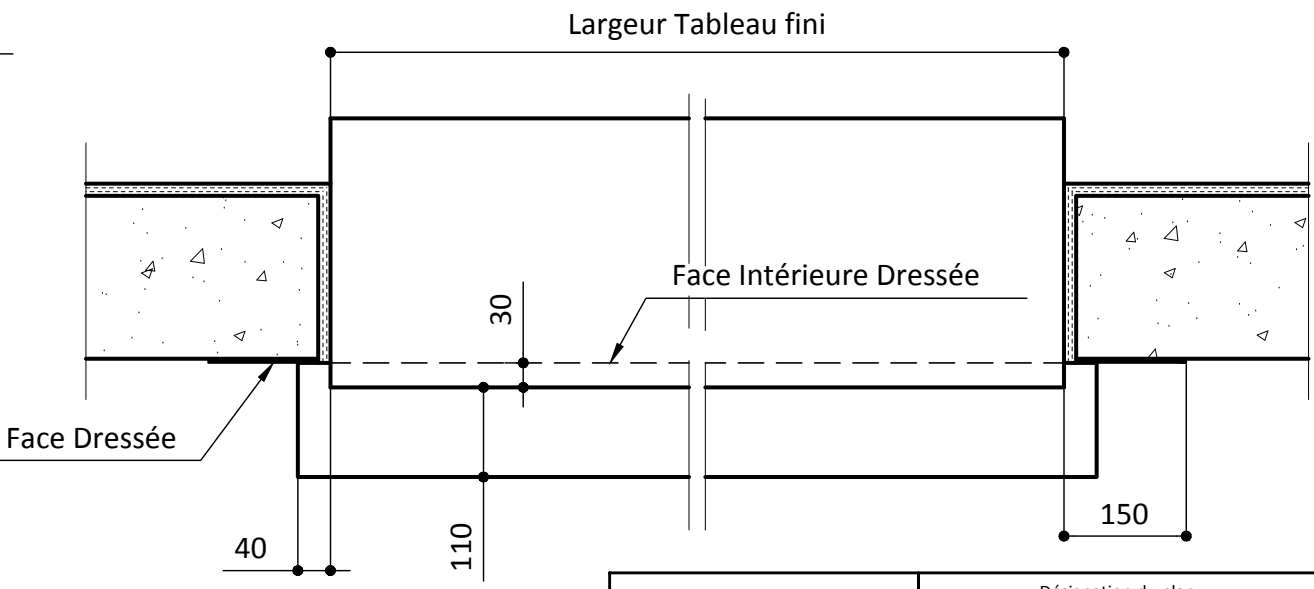

Désignation du plan : FRAPPE SUR SOL FINI - POSE 1D160 VR OPTIBAIÉ (pose dans demi-linteau)		
Fichier : ResaCAIB_Pvc_P1.dwg		
Des. : M.CHAUVIERE	Ech : 1 / 10	Y10
Date : 09/01/2018	N° :	10476

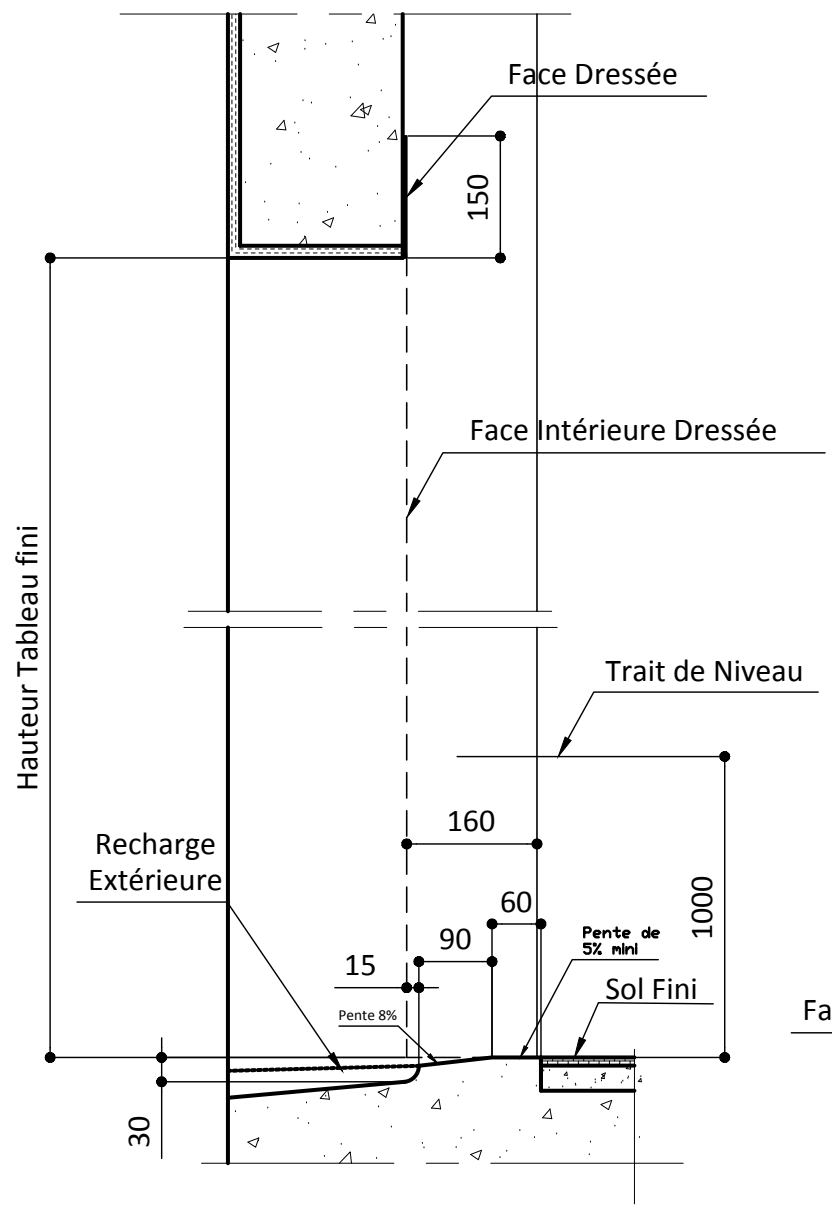

Hauteur Tableau fini

Face Dressée

150

Face Intérieure Dressée

Trait de Niveau

Recharge Extérieure

160

60

Pente de 5% mini

Sol Fini

15

90

Pente 8%

1000

30

SEUIL PMR

REPERE	TABLEAU FINI		SENS D'OUVERTURE	VITRAGE EXT / INT	OBSERVATIONS	QTE
	HAUTEUR	LARGEUR				

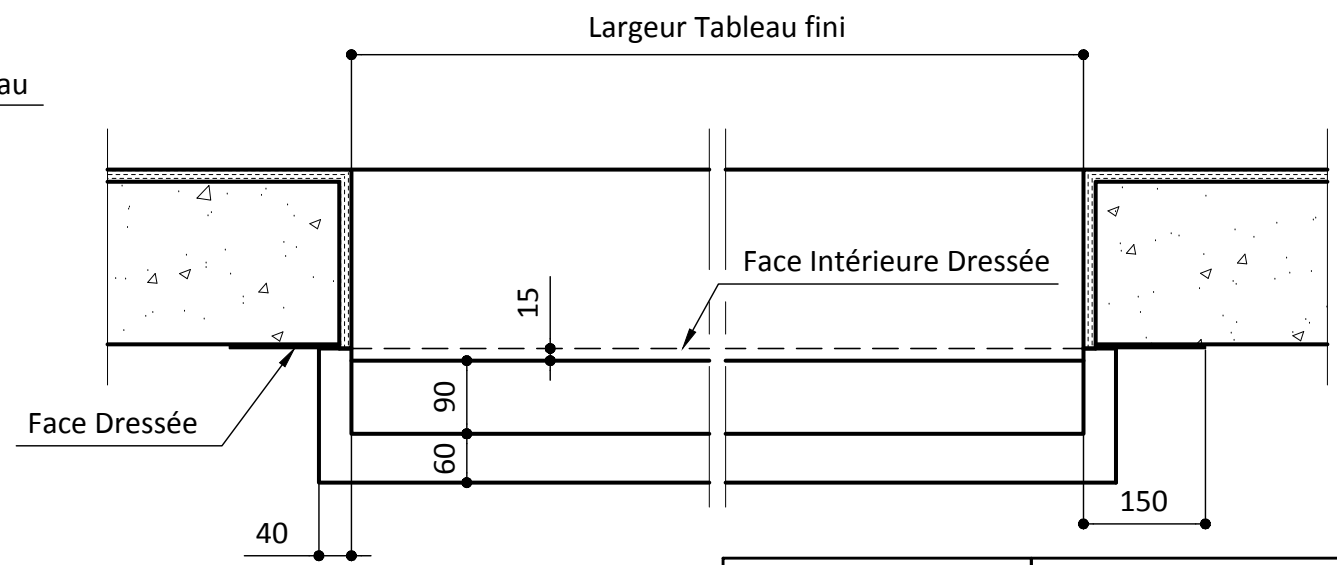

Largeur Tableau fini

Face Intérieure Dressée

Face Dressée

15

90

60

40

150



Désignation du plan :
 FRAPPE SEUIL PMR - POSE 1D160
 VR EVIBAIE - VR TRADITIONNEL

Fichier : ResaCAIB_Pvc_P1.dwg

Des. : M.CHAUVIERE Ech : 1 / 10 BB10

Date : 09/01/2018 N° : 10491

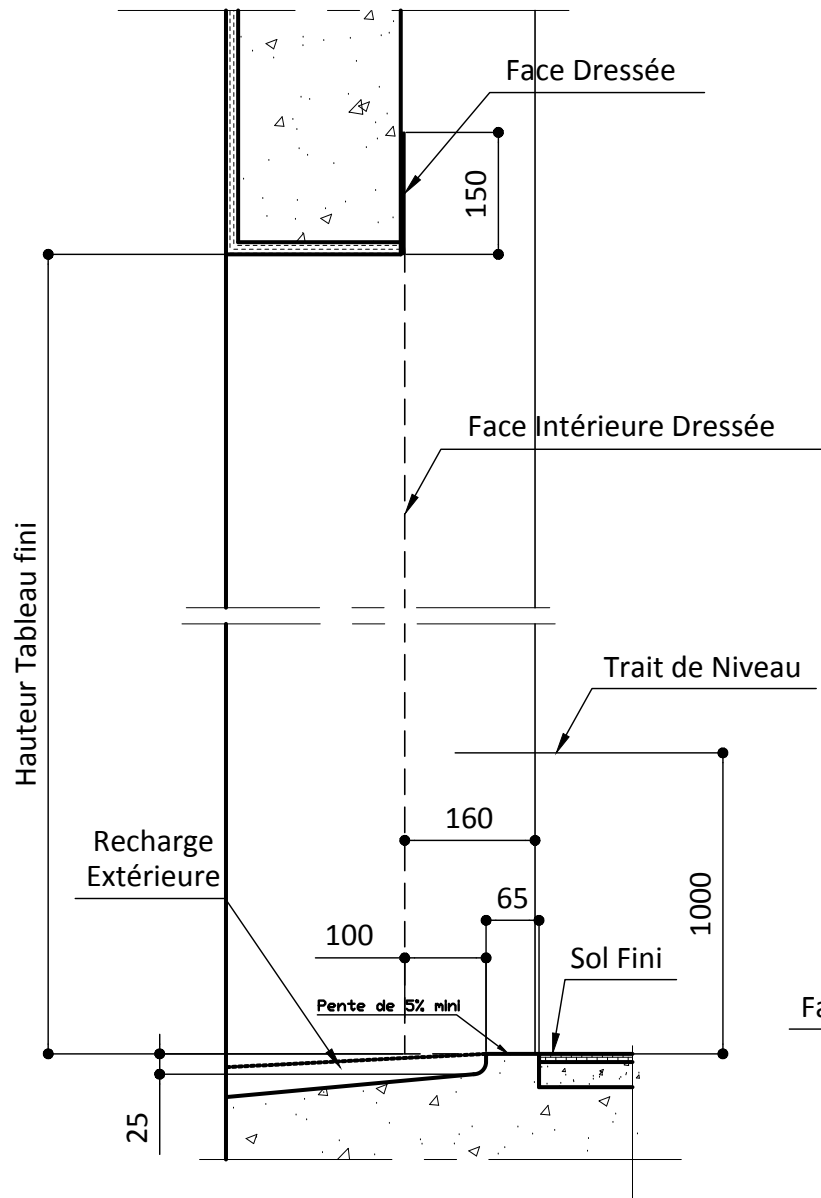

SEUIL PMR

REPERE	TABLEAU FINI		SENS D'OUVERTURE	VITRAGE EXT / INT	OBSERVATIONS	QTE
	HAUTEUR	LARGEUR				

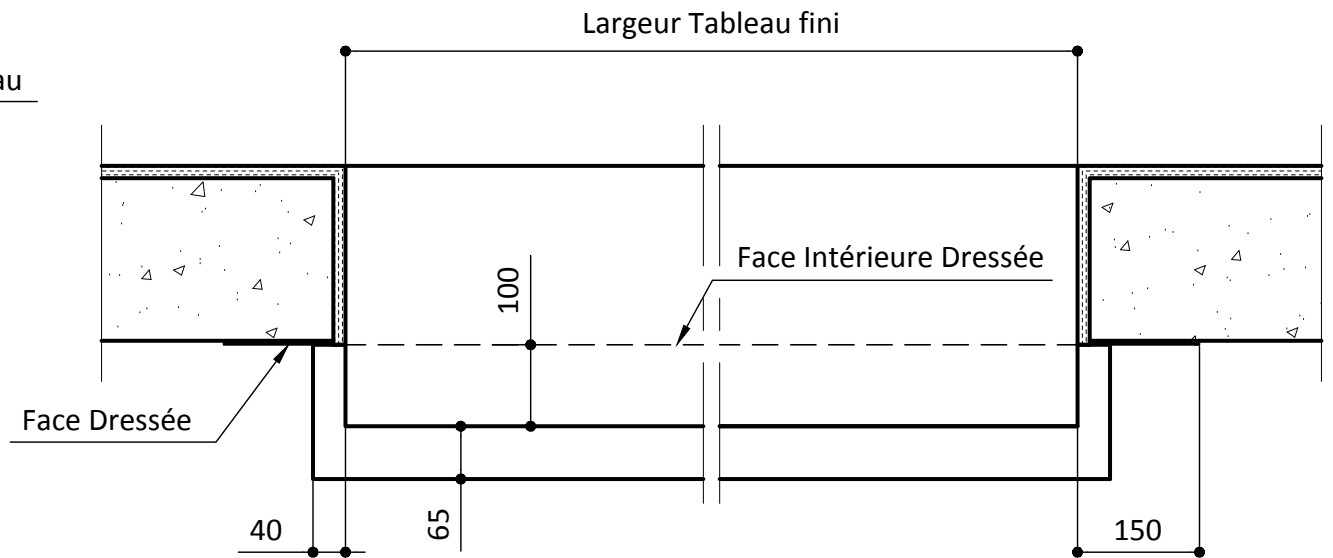

Désignation du plan : FRAPPE SEUIL PMR - POSE 1D160 SANS VR		
Fichier : ResaCAIB_Pvc_P1.dwg		
Des. : M.CHAUVIERE	Ech : 1 / 10	CC10
Date : 09/01/2018	N° : 10496	

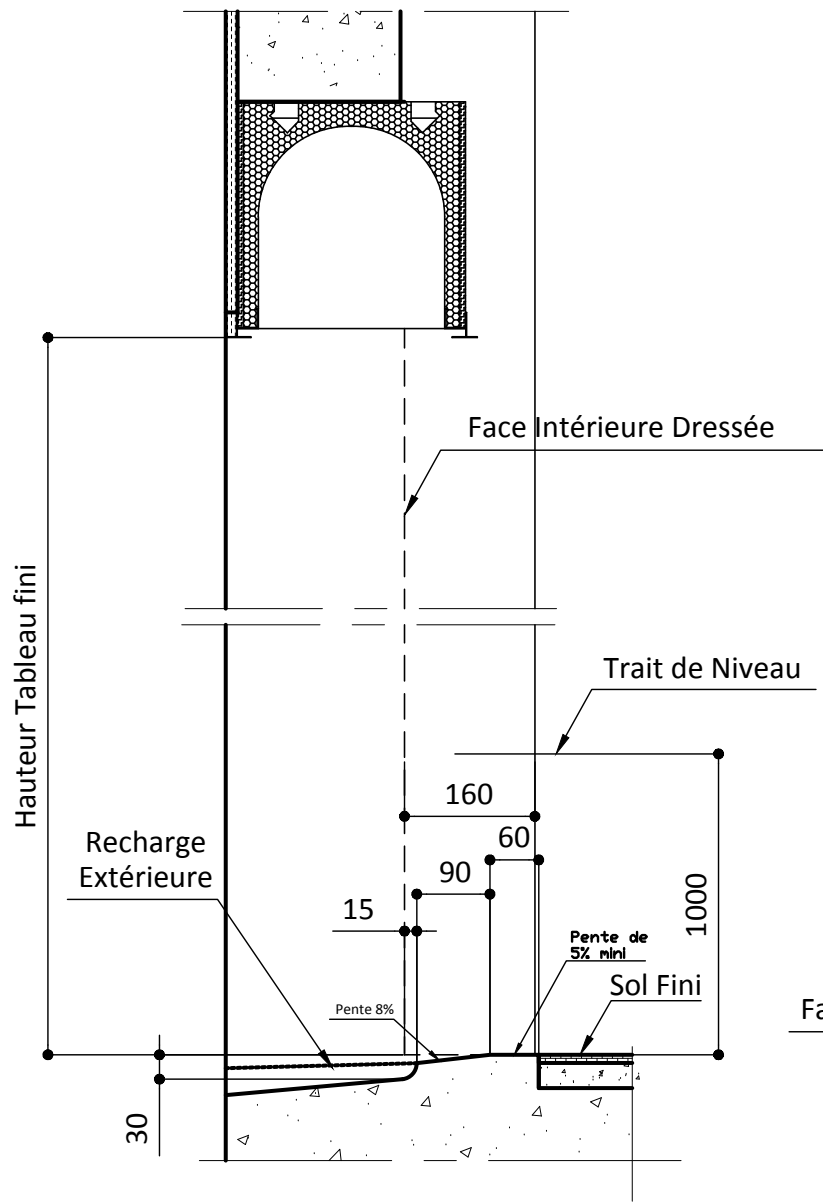

SEUIL PMR

REPERE	TABLEAU FINI		SENS D'OUVERTURE	VITRAGE EXT / INT	OBSERVATIONS	QTE
	HAUTEUR	LARGEUR				

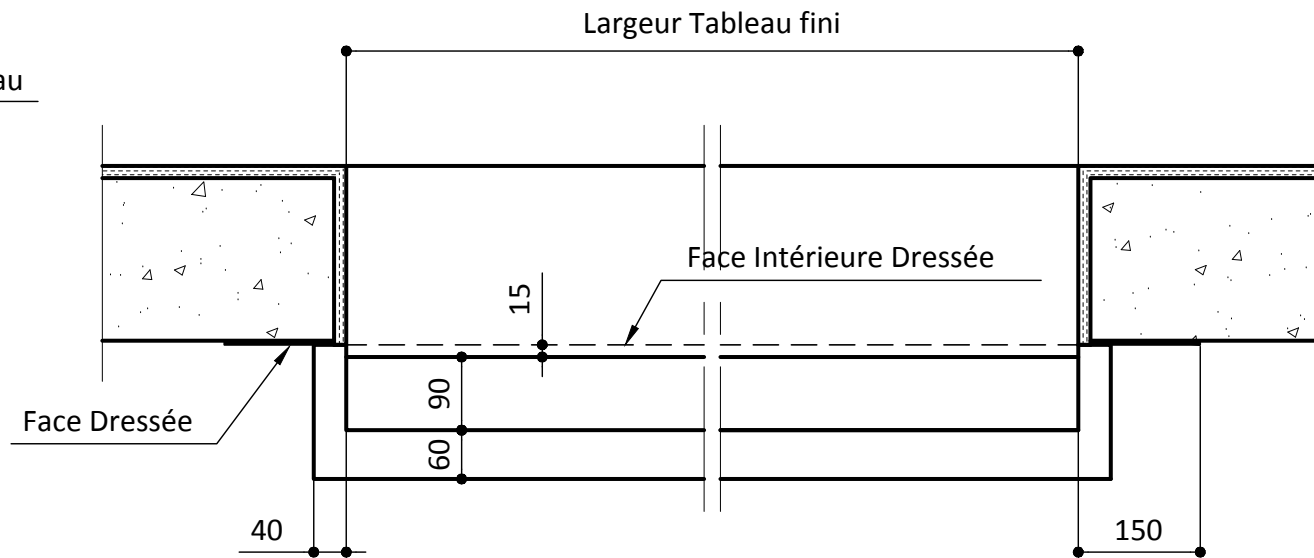

Désignation du plan :
 FRAPPE SEUIL PMR - POSE 1D160
 VR PREFA (enroulement ext. et int.)
 Fichier : ResaCAIB_Pvc_P1.dwg
 Des. : M.CHAUVIERE Ech : 1 / 10 DD10
 Date : 09/01/2018 N° : 10501

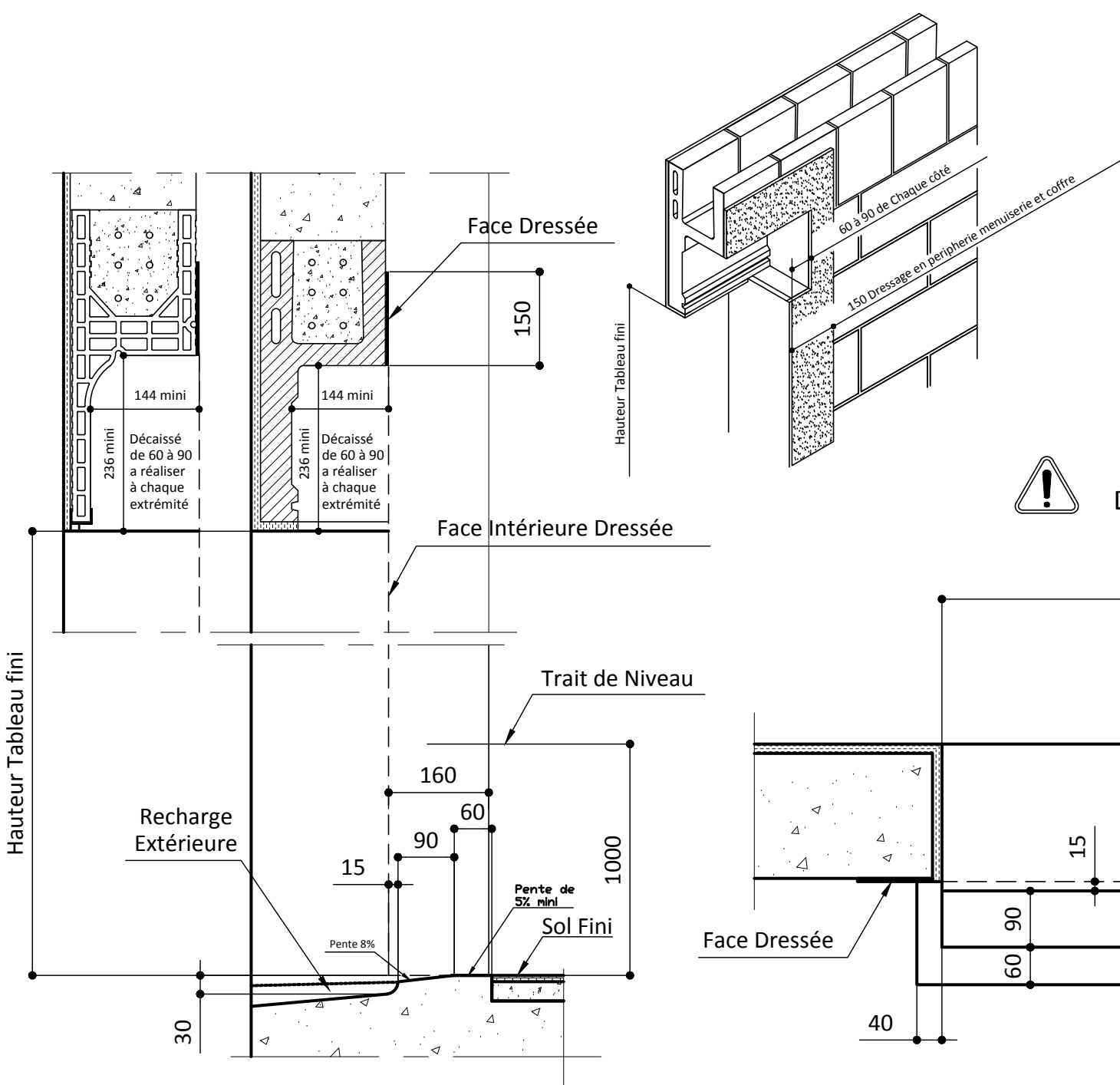

REPERE	TABLEAU FINI		SENS D'OUVERTURE	QTE
	HAUTEUR	LARGEUR		

ATTENTION! UTILISER UN TYPE DE DEMI-COFFRE PRÉCONISÉ PAR NOTRE B.E

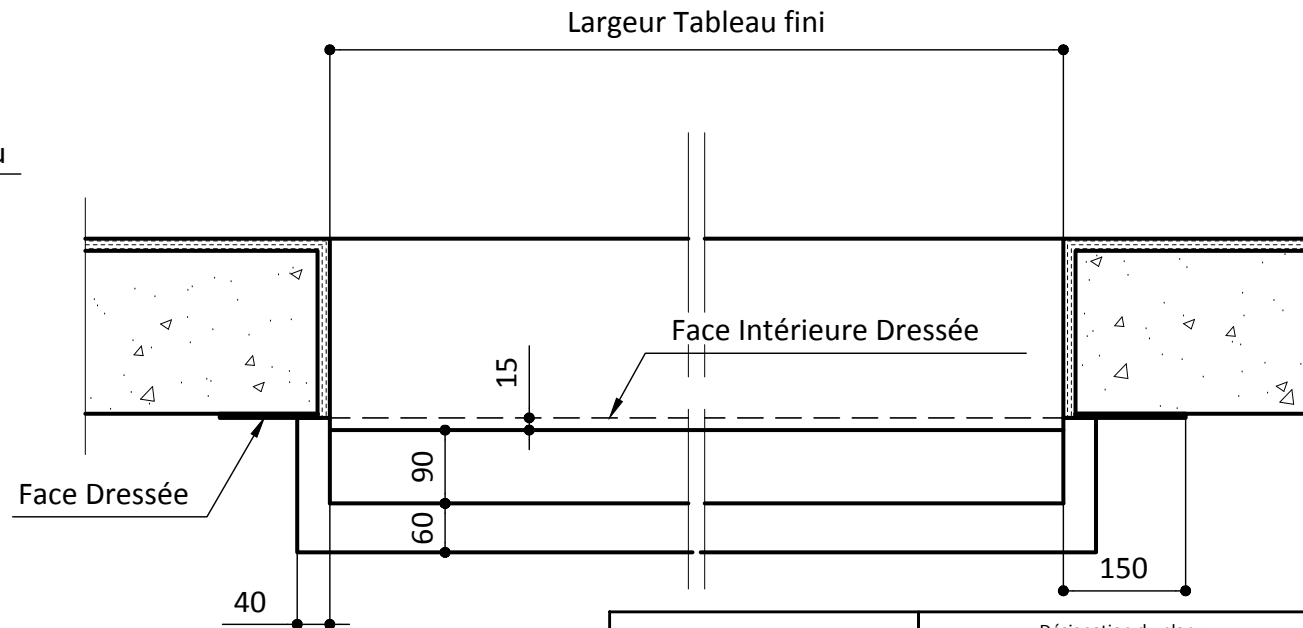

SEUIL PMR



Désignation du plan : FRAPPE SEUIL PMR - POSE 1D160 VR OPTIBAIE (pose dans demi-linteau)	
Fichier : ResaCAIB_Pvc_P1.dwg	
Des. : M.CHAUVIERE	Ech : 1 / 10 EE10
Date : 09/01/2018	N° : 10506

RESERVATIONS MAÇONNERIE
SI SEUILS ELARGIS en DOUBLAGE de 160mm

POSITIONNER L'APPUI MAÇONNERIE EN FONCTION DU SEUIL CHOISI

SUR ALLEGE
MAÇONNERIE

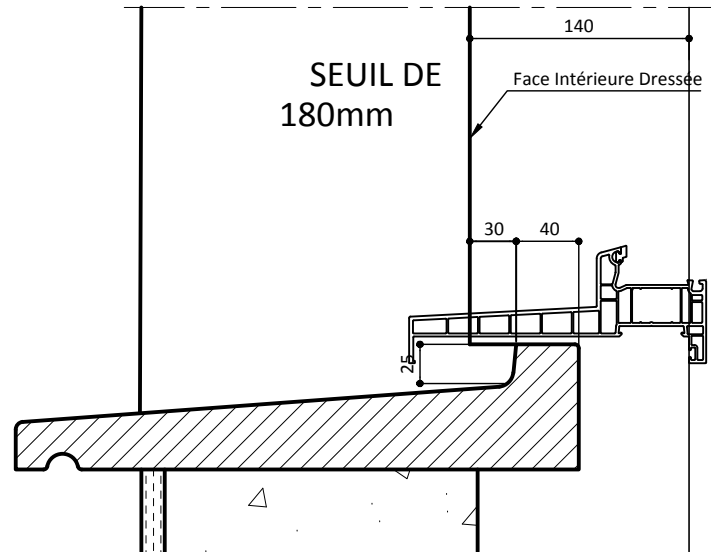

SUR SOL FINI

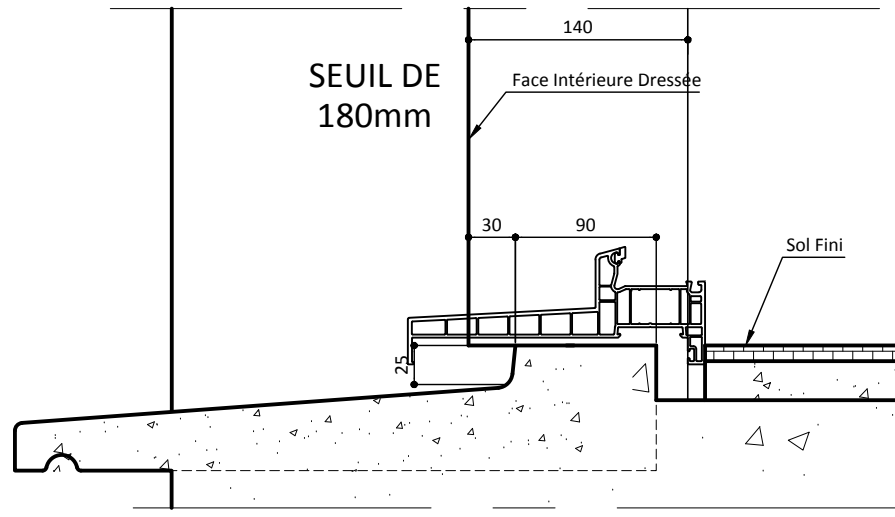

	Désignation du plan :	
	FRAPPE SEUIL ELARGI - POSE 1D160 SUR ALLEGE ET SOL FINI	
Fichier : ResaCAIB_Pvc_P1.dwg		
Des. : M.CHAUVIERE	Ech : 1 / 5	I19
Date : 09/01/2018	N° : 10526	

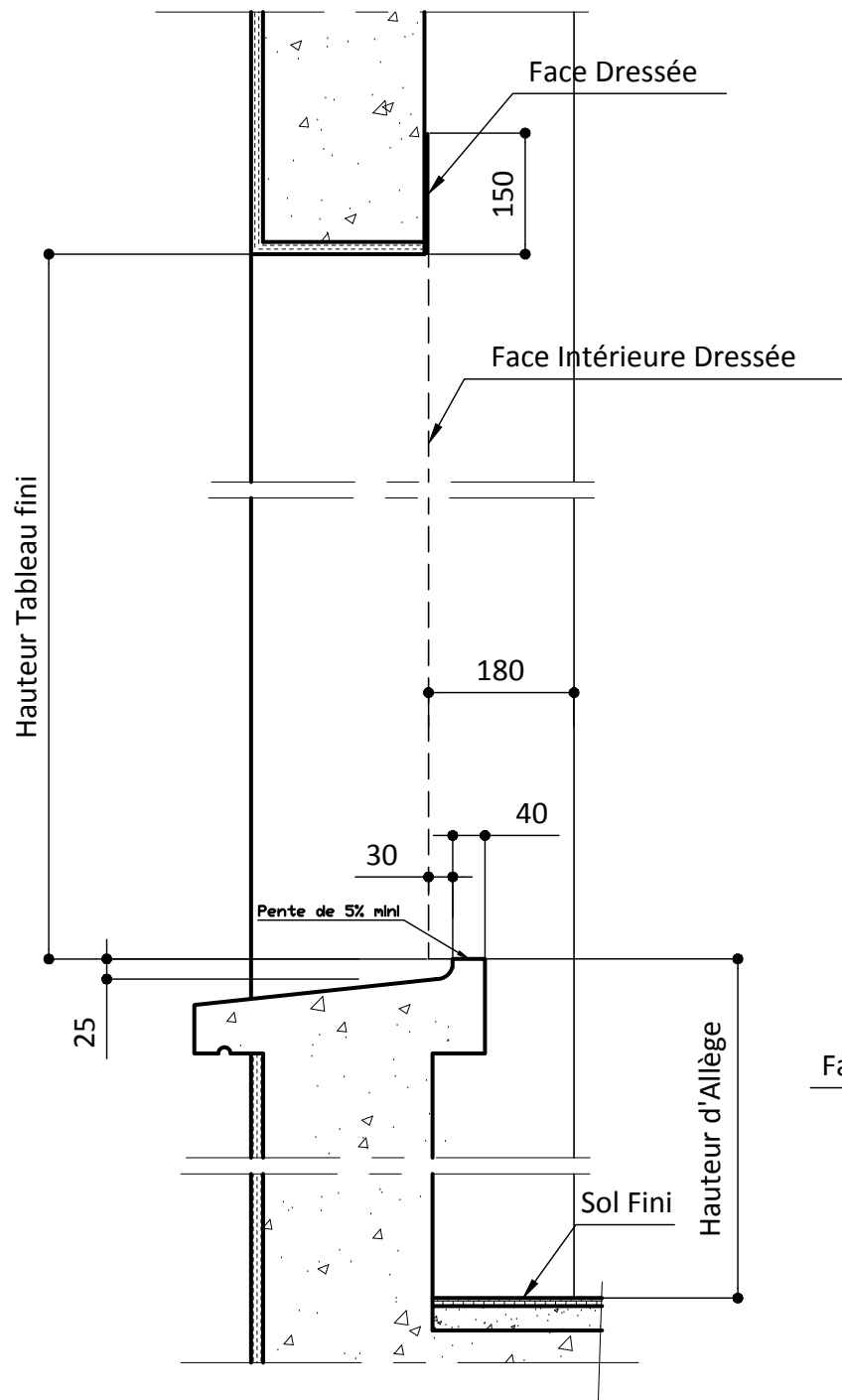

REPÈRE	TABLEAU FINI		SENS D'OUVERTURE	VITRAGE EXT / INT	OBSERVATIONS	QTE
	HAUTEUR	LARGEUR				

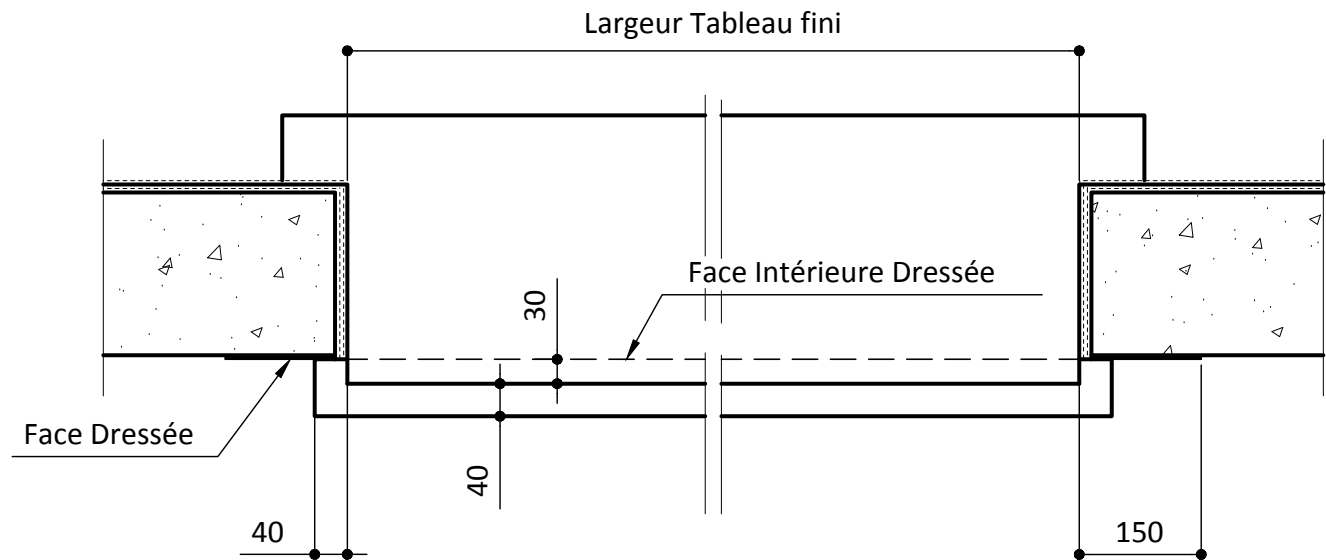

Désignation du plan :
 FRAPPE SUR ALLEGE - POSE 1D180
 SANS VR - VR EVIBAIE - VR TRADITIONNEL
 Fichier : ResaCAIB_Pvc_P1.dwg
 Des. : M.CHAUVIERE Ech : 1 / 10 T11
 Date : 09/01/2018 N° : 10541

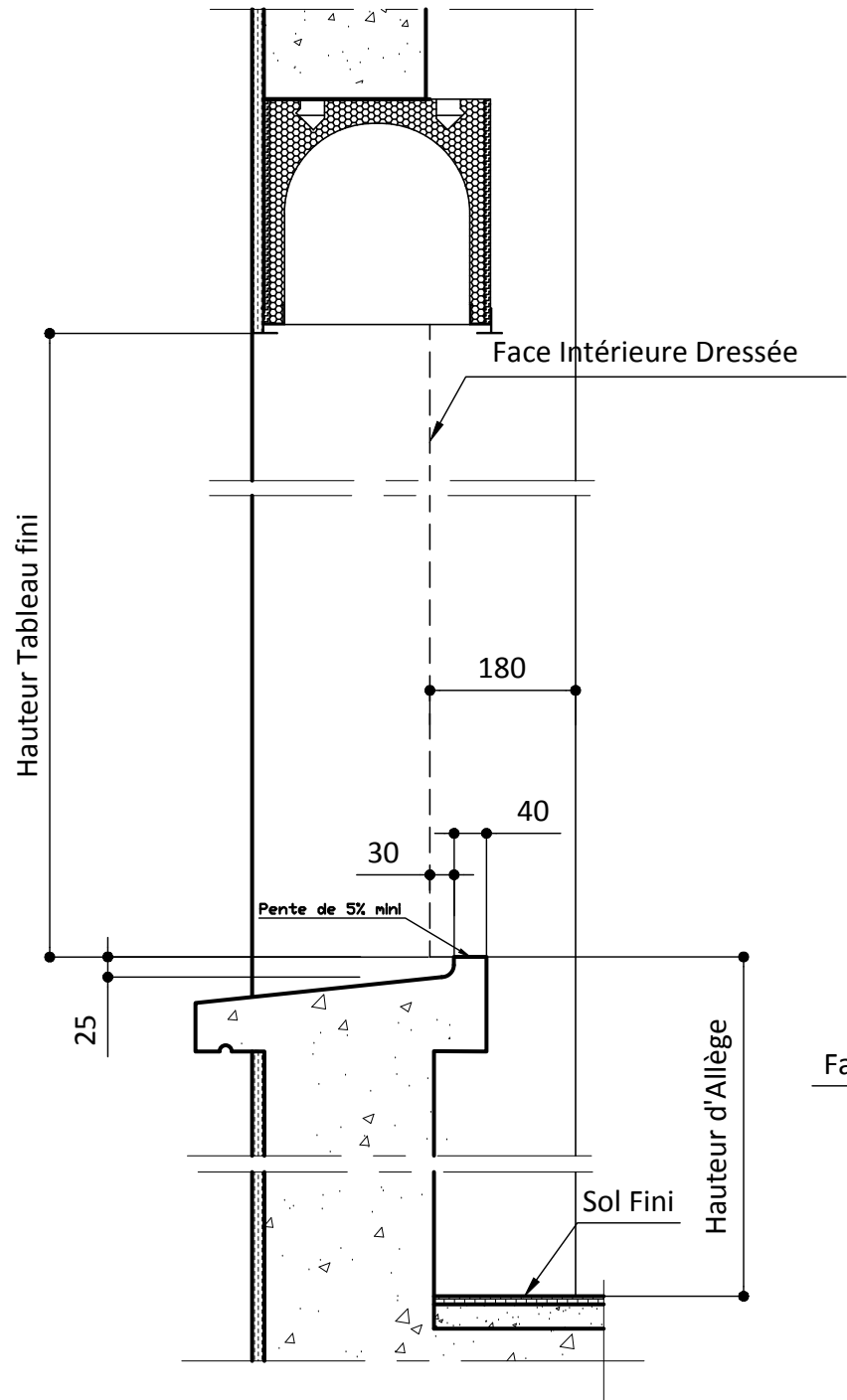

REPERE	TABLEAU FINI		SENS D'OUVERTURE	VITRAGE EXT / INT	OBSERVATIONS	QTE
	HAUTEUR	LARGEUR				

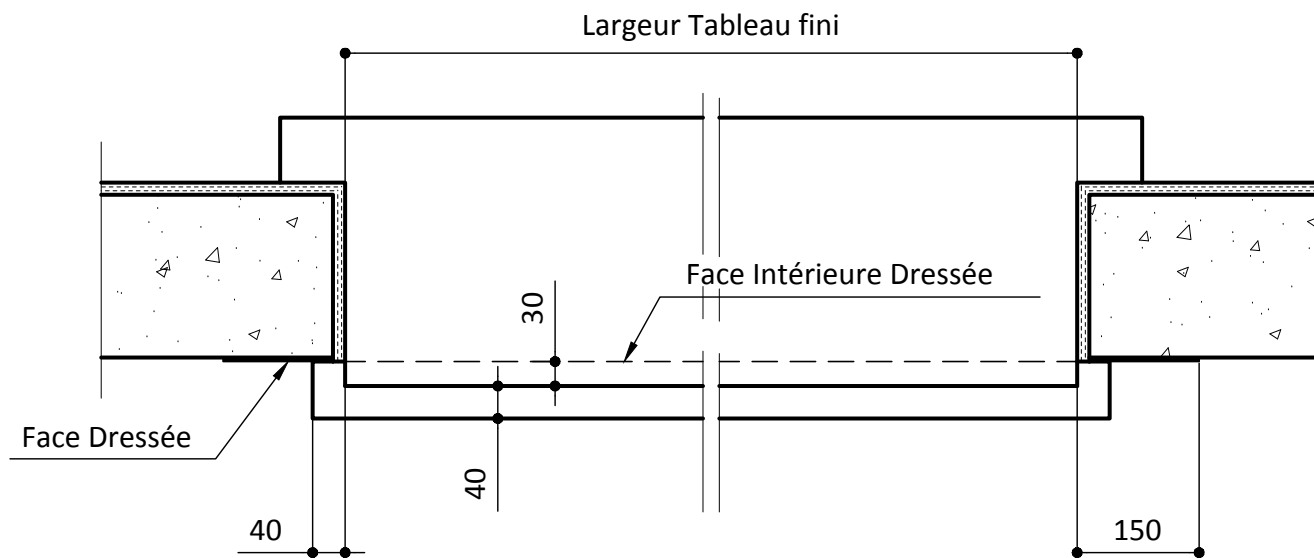

Désignation du plan :
 FRAPPE SUR ALLEGE - POSE 1D180
 VR PREFA (enroulement ext. et int.)

Fichier : ResaCAIB_Pvc_P1.dwg

Des. : M.CHAUVIERE Ech : 1 / 10 U11

Date : 09/01/2018 N° : 10546

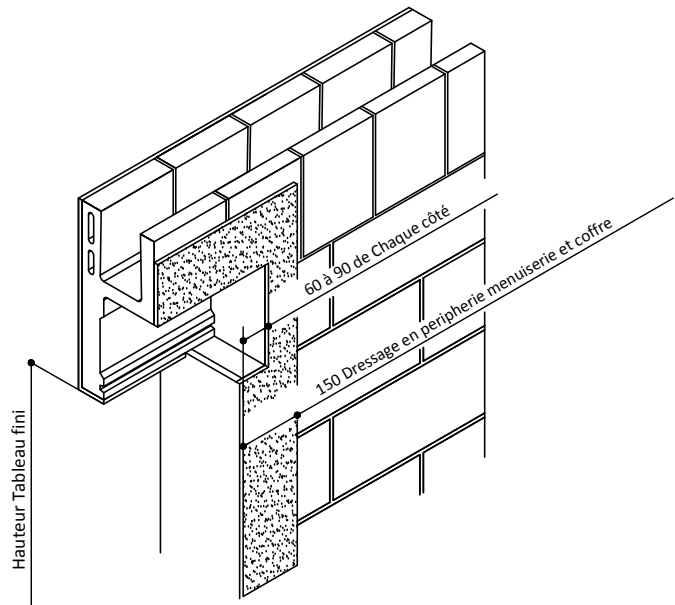
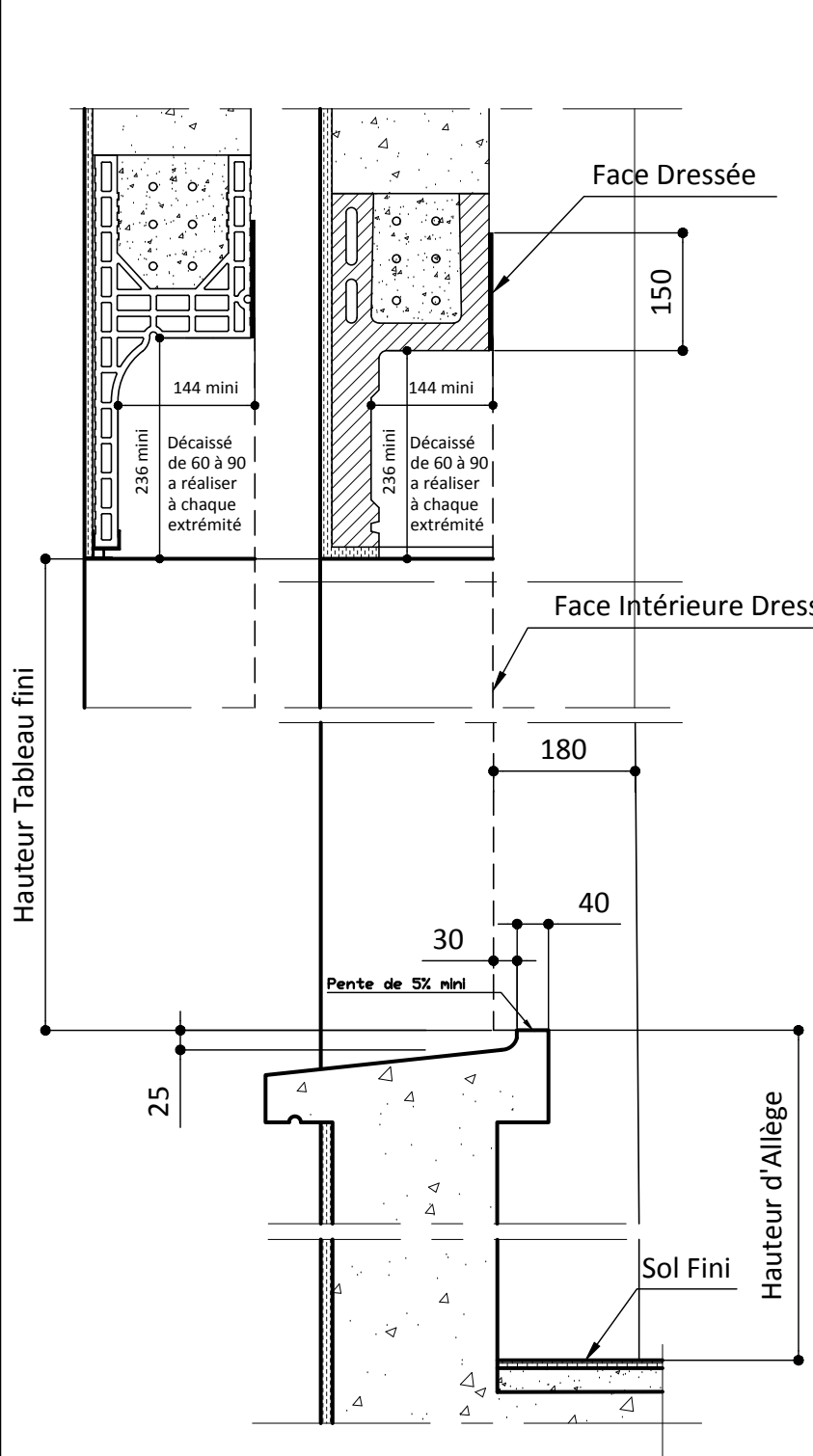

REPÈRE	TABLEAU FINI		SENS D'OUVERTURE	QTE
	HAUTEUR	LARGEUR		



ATTENTION! UTILISER UN TYPE DE DEMI-COFFRE PRÉCONISÉ PAR NOTRE B.E

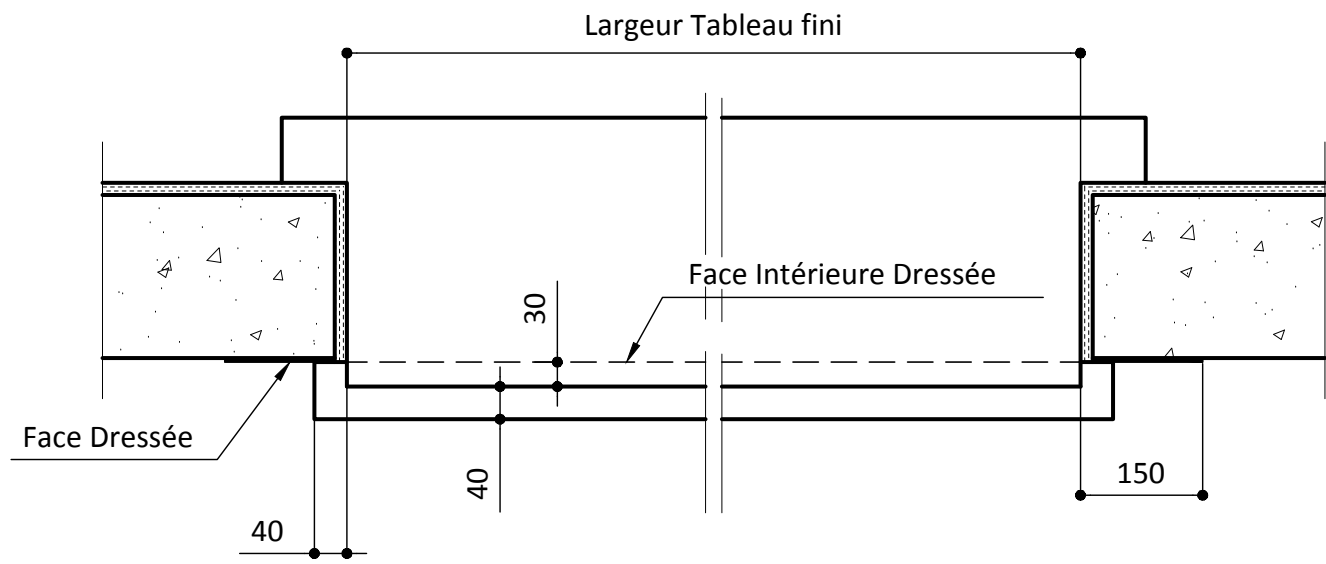

Désignation du plan :
 FRAPPE SUR ALLEGE - POSE 1D180
 VR OPTIBAIÉ (pose dans demi-linteau)

Fichier : ResaCAIB_Pvc_P1.dwg

Des. : M.CHAUVIERE Ech : 1 / 10 V11

Date : 09/01/2018 N° : 10551

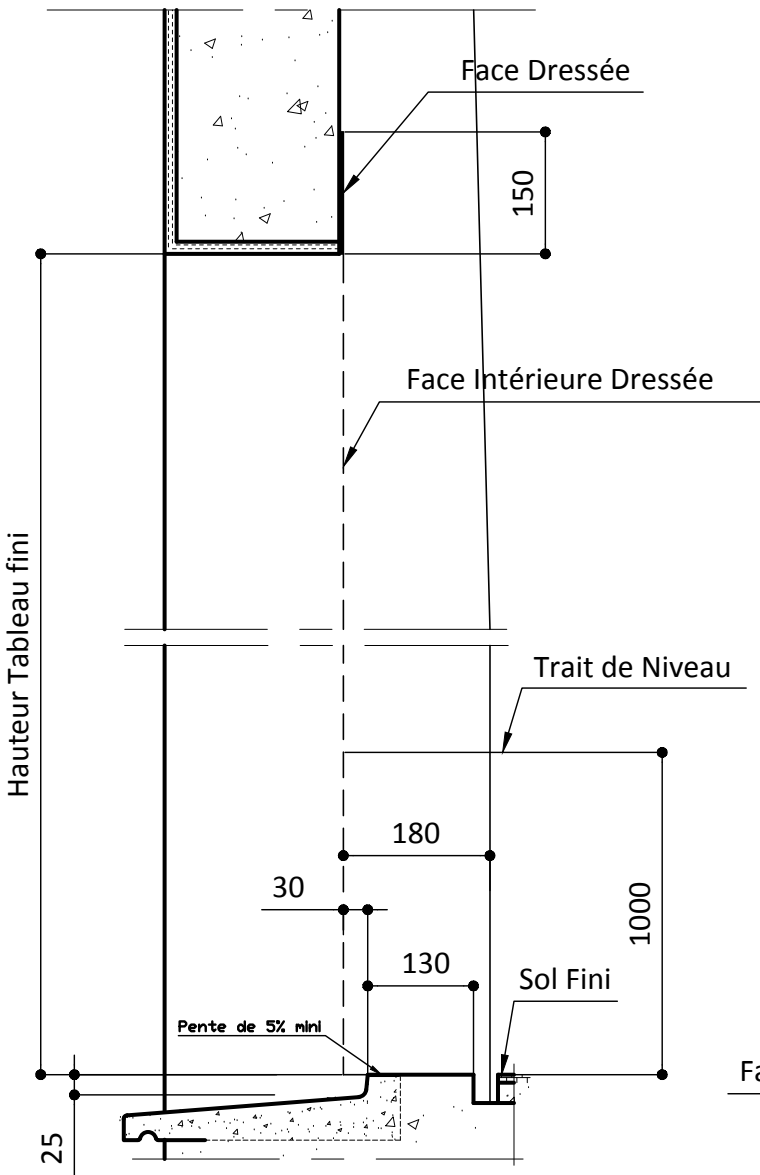

SEUIL STANDARD

REPÈRE	TABLEAU FINI		SENS D'OUVERTURE	VITRAGE EXT / INT	OBSERVATIONS	QTE
	HAUTEUR	LARGEUR				

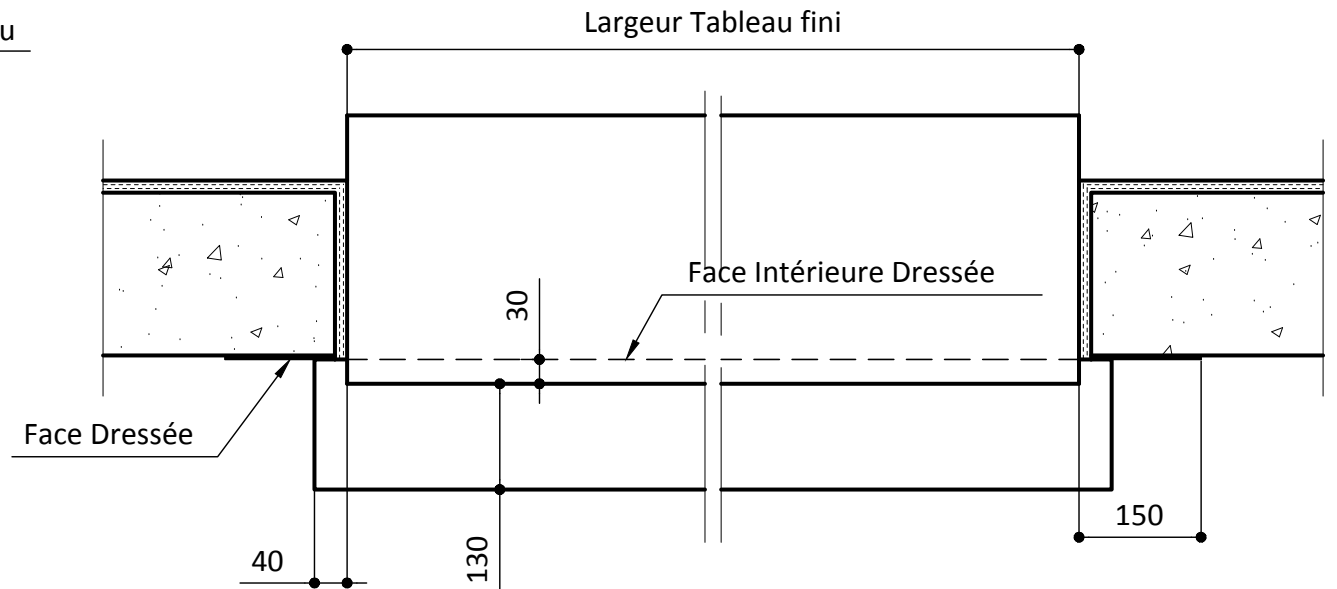

Désignation du plan :
 FRAPPE SUR SOL FINI - POSE 1D180
 SANS VR - VR EVIBAIE - VR TRADITIONNEL
 Fichier : ResaCAIB_Pvc_P1.dwg
 Des. : M.CHAUVIERE Ech :1 / 10 W11
 Date : 09/01/2018 N° : 10556

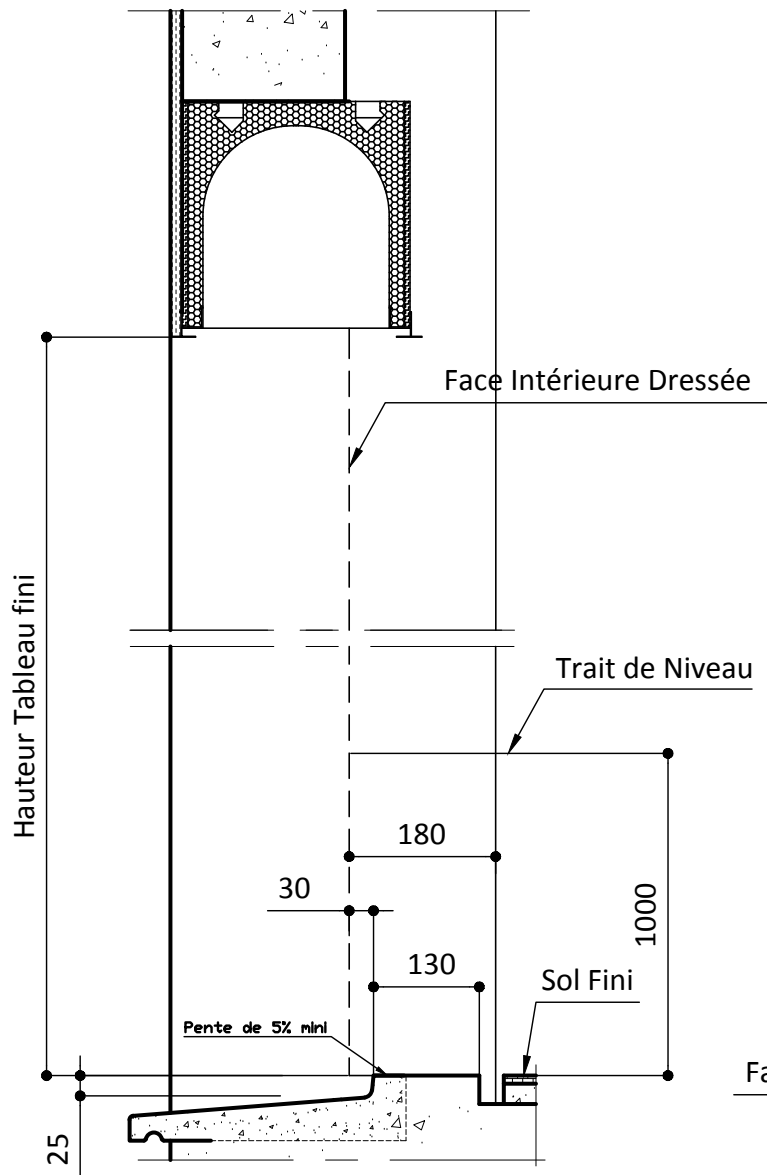

SEUIL STANDARD

REPÈRE	TABLEAU FINI		SENS D'OUVERTURE	VITRAGE EXT / INT	OBSERVATIONS	QTE
	HAUTEUR	LARGEUR				

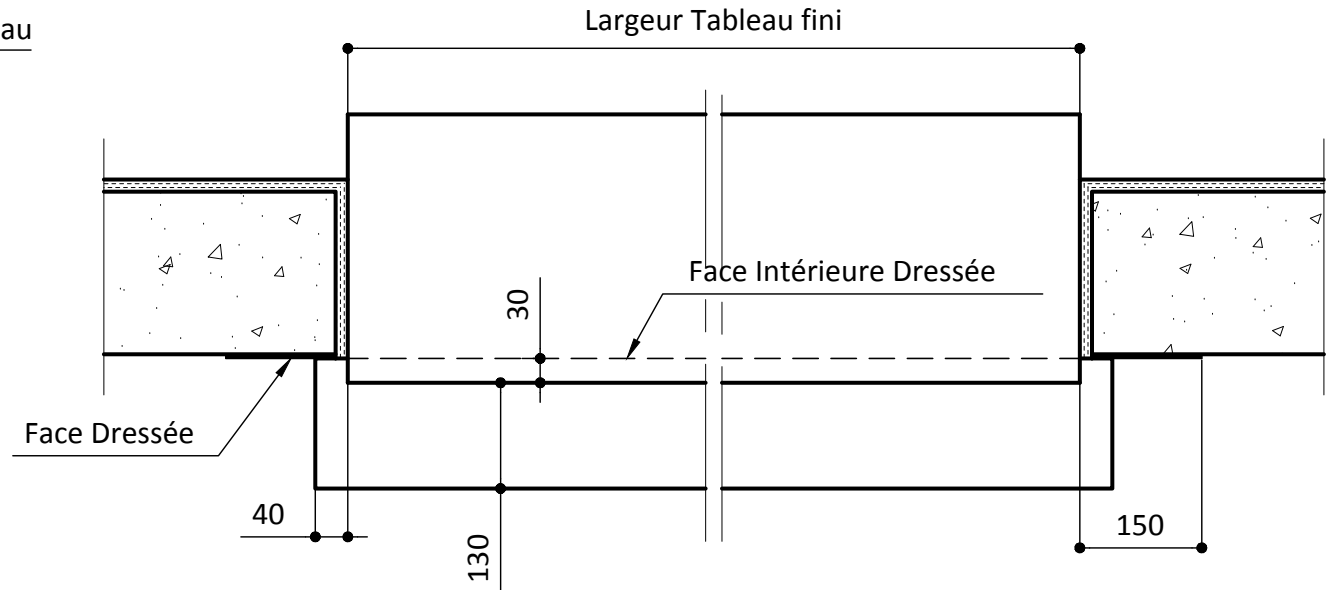

Désignation du plan :
 FRAPPE SUR SOL FINI - POSE 1D180
 VR PREFA (enroulement ext. et int.)

Fichier : ResaCAIB_Pvc_P1.dwg

Des. : M.CHAUVIERE Ech : 1 / 10 X11

Date : 09/01/2018 N° : 10561

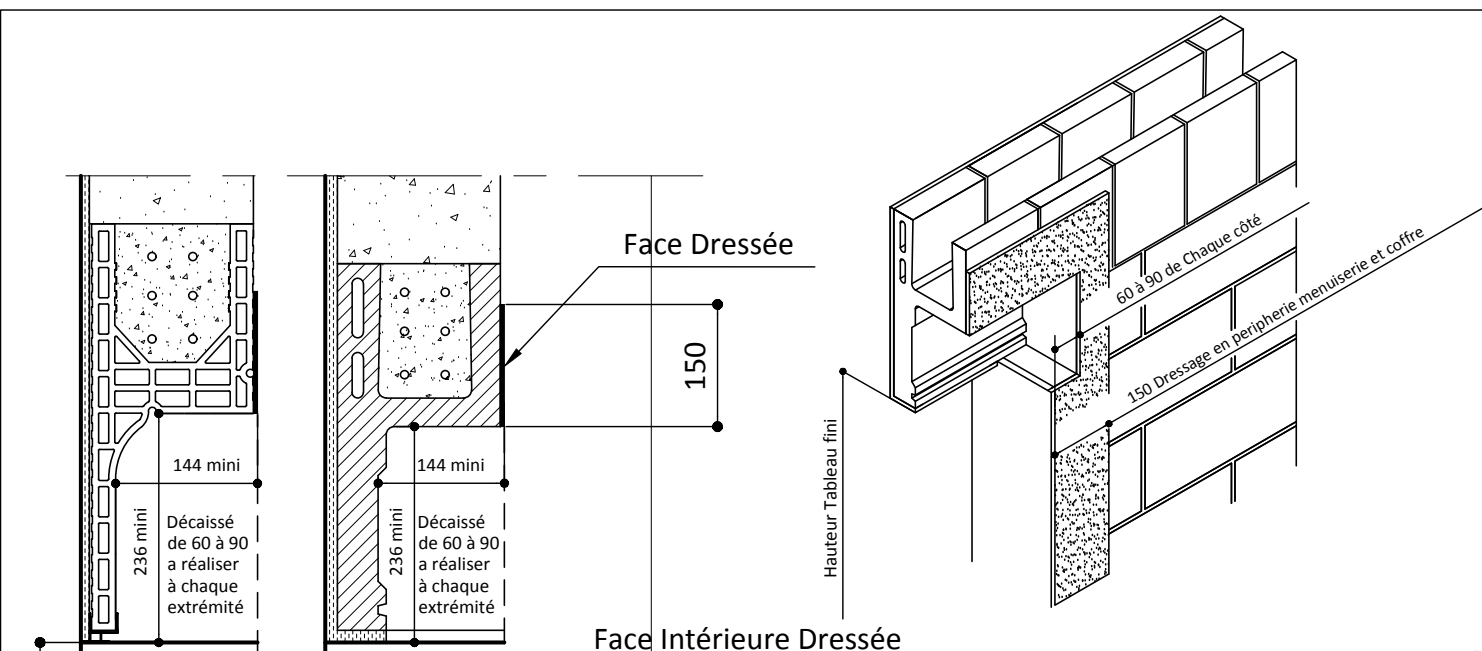

REPÈRE	TABLEAU FINI		SENS D'OUVERTURE	QTE
	HAUTEUR	LARGEUR		



ATTENTION! UTILISER UN TYPE DE DEMI-COFFRE PRÉCONISÉ PAR NOTRE B.E

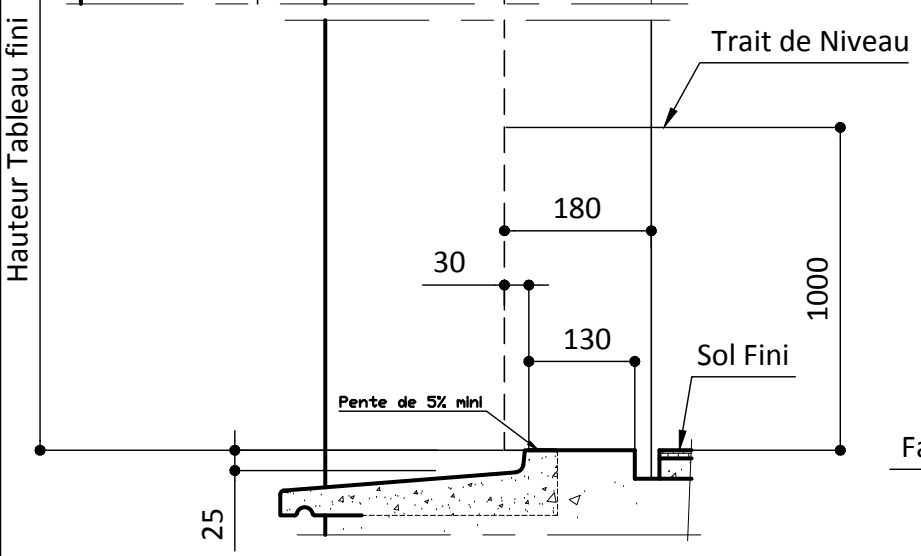

SEUIL STANDARD

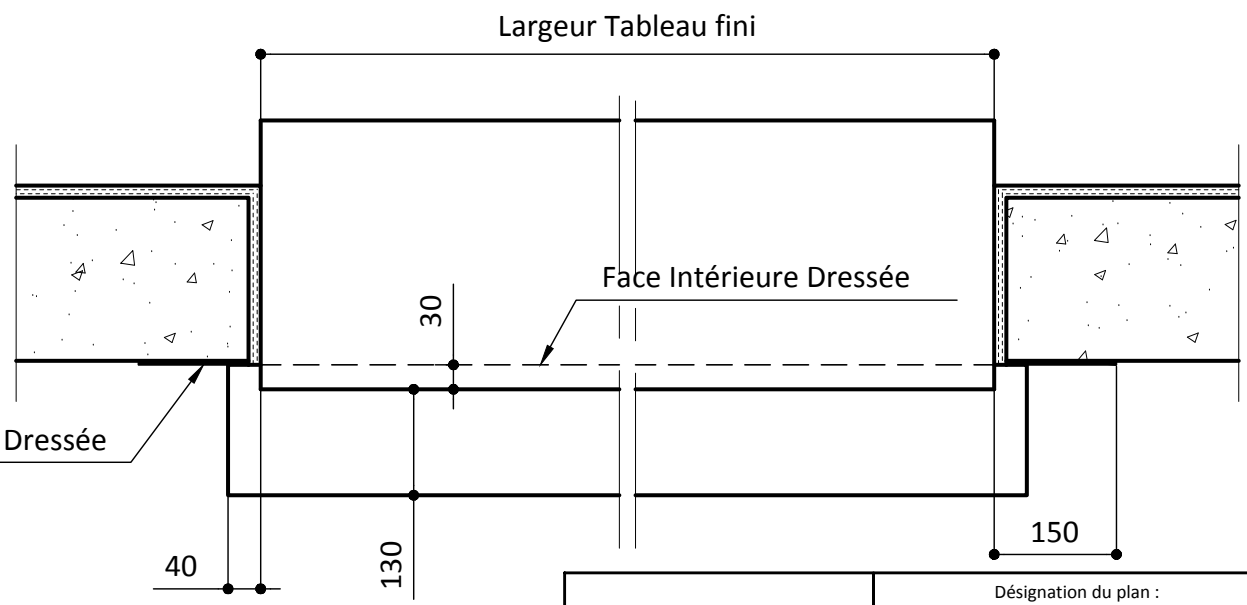

Désignation du plan : FRAPPE SUR SOL FINI - POSE 1D180 VR OPTIBAIÉ (pose dans demi-linteau)		
Fichier : ResaCAIB_Pvc_P1.dwg		
Des. : M.CHAUVIERE	Ech : 1 / 10	Y11
Date : 09/01/2018	N° :	10566

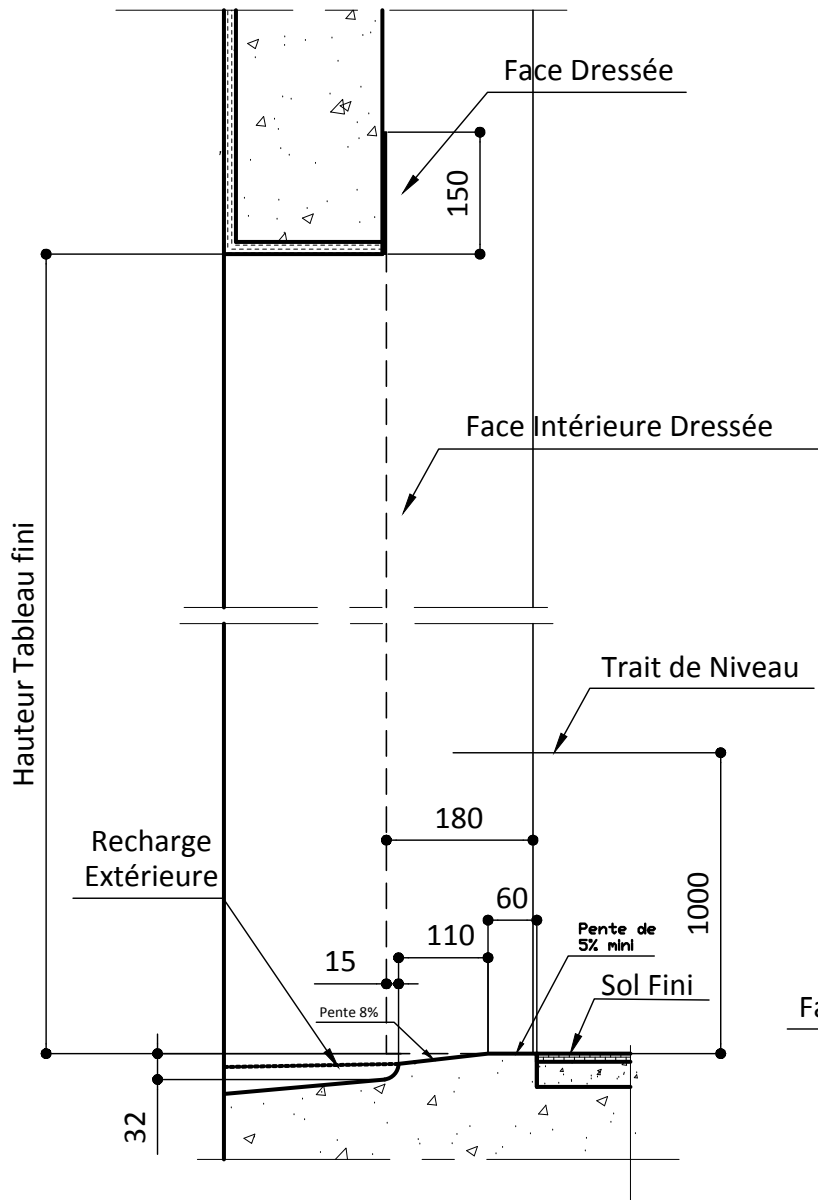

SEUIL PMR

REPERE	TABLEAU FINI		SENS D'OUVERTURE	VITRAGE EXT / INT	OBSERVATIONS	QTE
	HAUTEUR	LARGEUR				

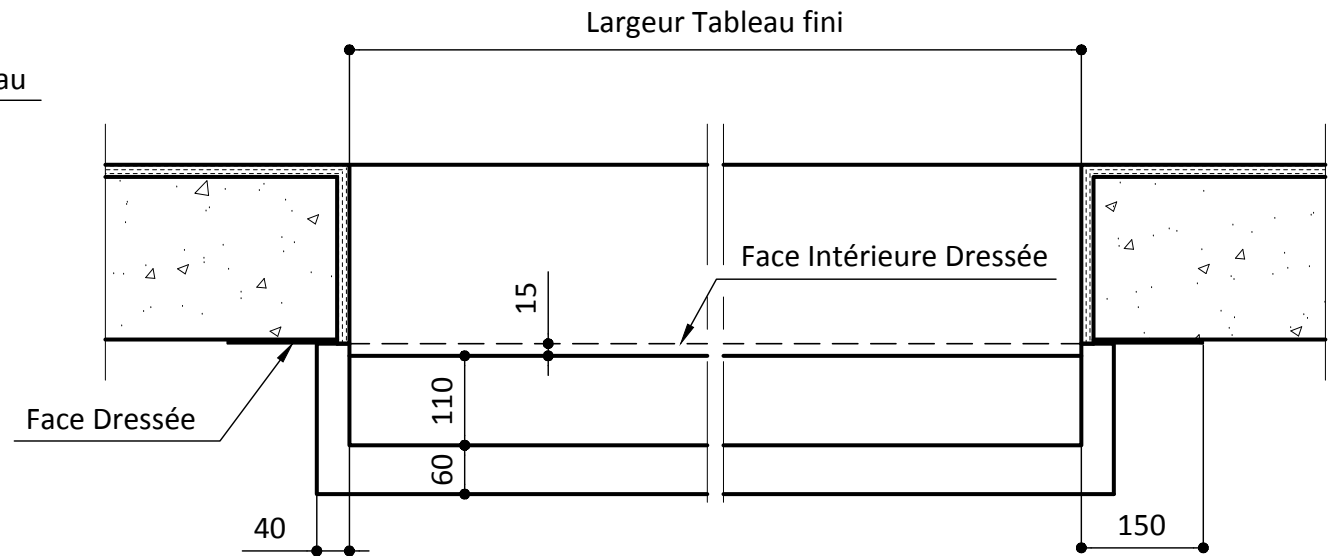

Désignation du plan :
 FRAPPE SEUIL PMR - POSE 1D180
 VR EVIBAIE - VR TRADITIONNEL

Fichier : ResaCAIB_Pvc_P1.dwg

Des. : M.CHAUVIERE Ech :1 / 10 BB11

Date : 09/01/2018 N° : 10581

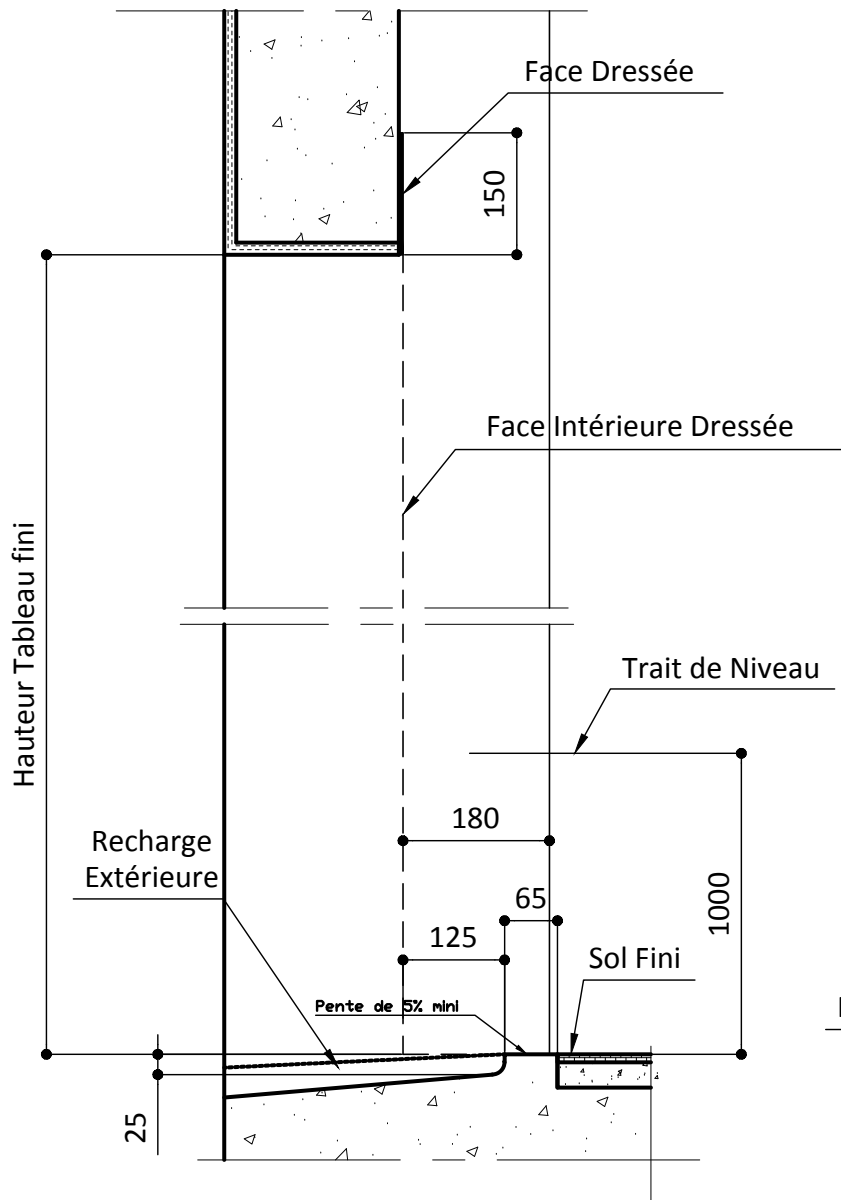

SEUIL PMR

REPERE	TABLEAU FINI		SENS D'OUVERTURE	VITRAGE EXT / INT	OBSERVATIONS	QTE
	HAUTEUR	LARGEUR				

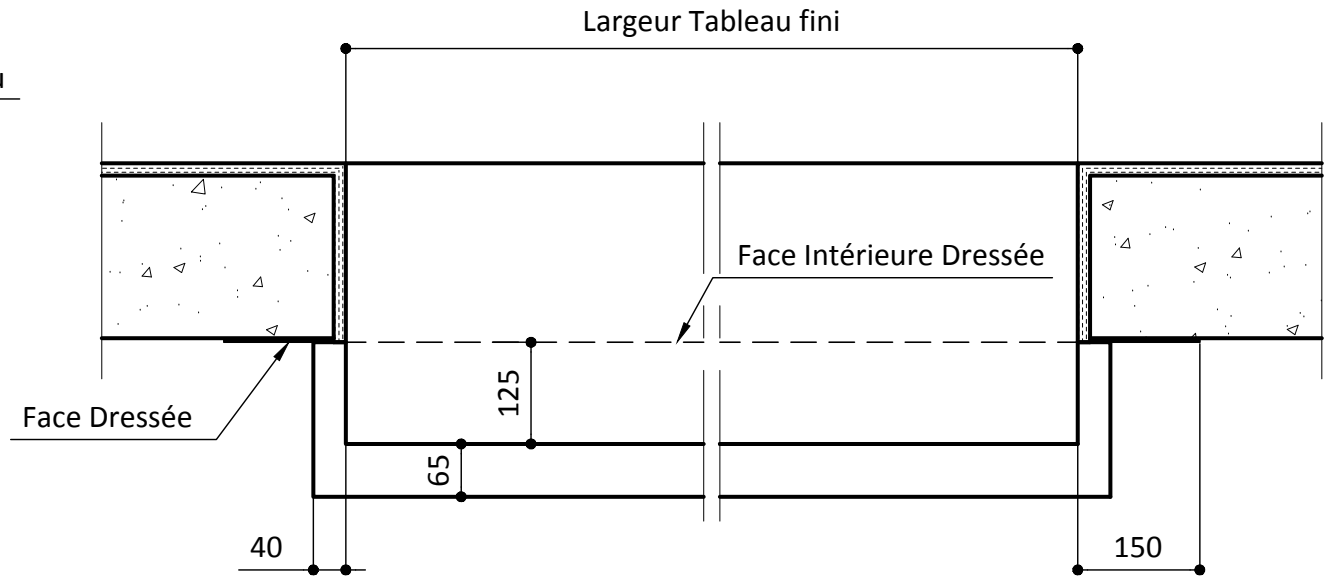

Désignation du plan : FRAPPE SEUIL PMR - POSE 1D180 SANS VR		
Fichier : ResaCAIB_Pvc_P1.dwg		
Des. : M.CHAUVIERE	Ech : 1 / 10	CC11
Date : 09/01/2018	N° :	10586

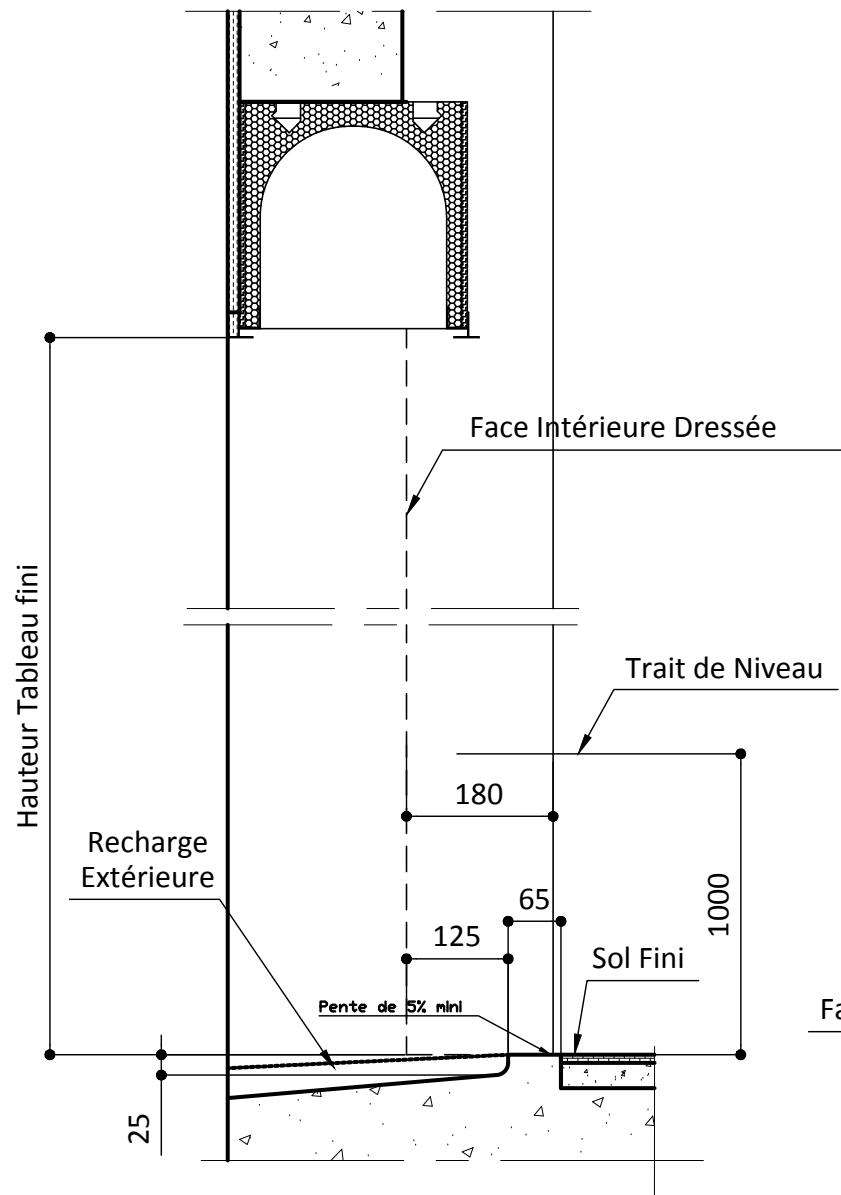

SEUIL PMR

REPERE	TABLEAU FINI		SENS D'OUVERTURE	VITRAGE EXT / INT	OBSERVATIONS	QTE
	HAUTEUR	LARGEUR				

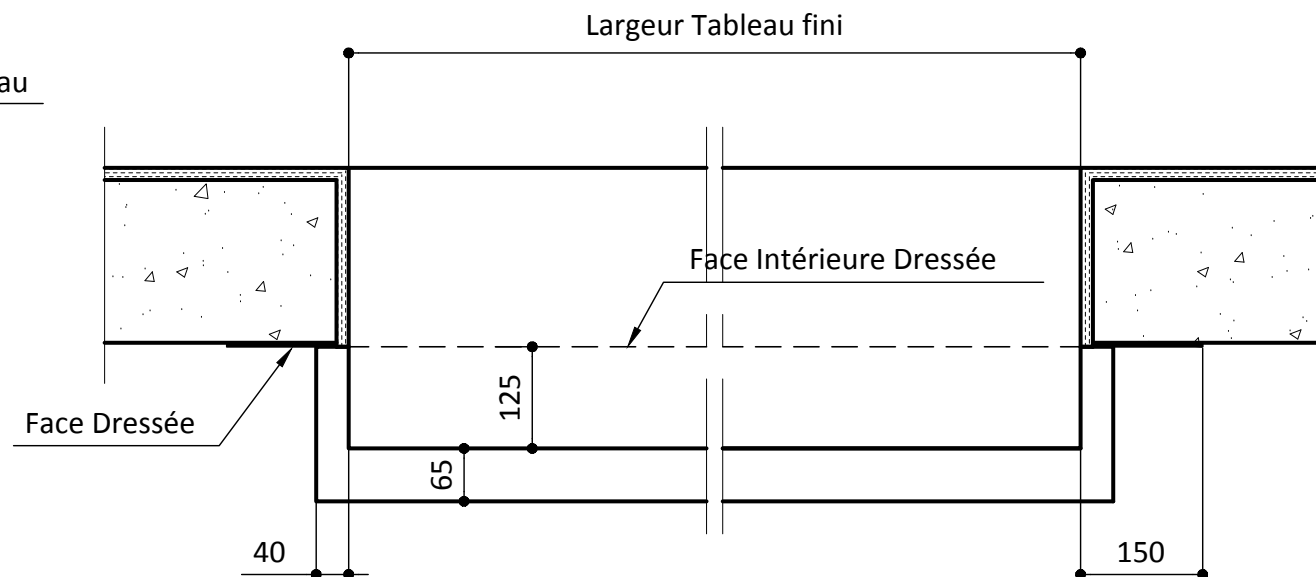

Désignation du plan :
 FRAPPE SEUIL PMR - POSE 1D180
 VR PREFA (enroulement ext. et int.)

Fichier : ResaCAIB_Pvc_P1.dwg

Des. : M.CHAUVIERE Ech : 1 / 10 DD11

Date : 09/01/2018 N° : 10591

REPÈRE	TABLEAU FINI		SENS D'OUVERTURE	QTE
	HAUTEUR	LARGEUR		

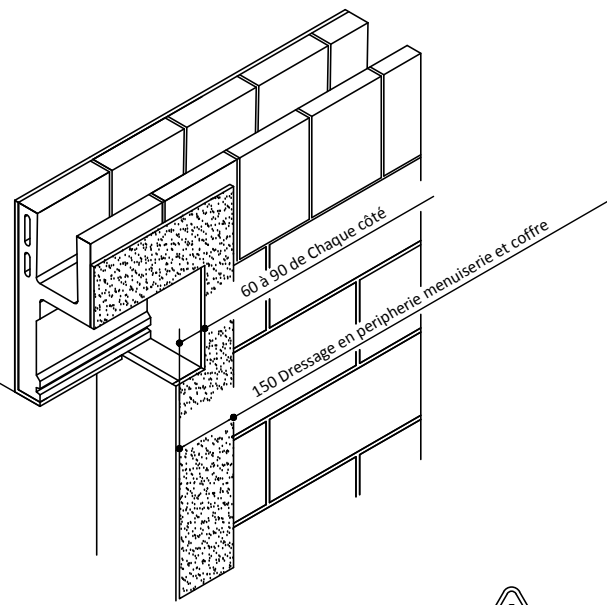

ATTENTION! UTILISER UN TYPE DE DEMI-COFFRE PRÉCONISÉ PAR NOTRE B.E

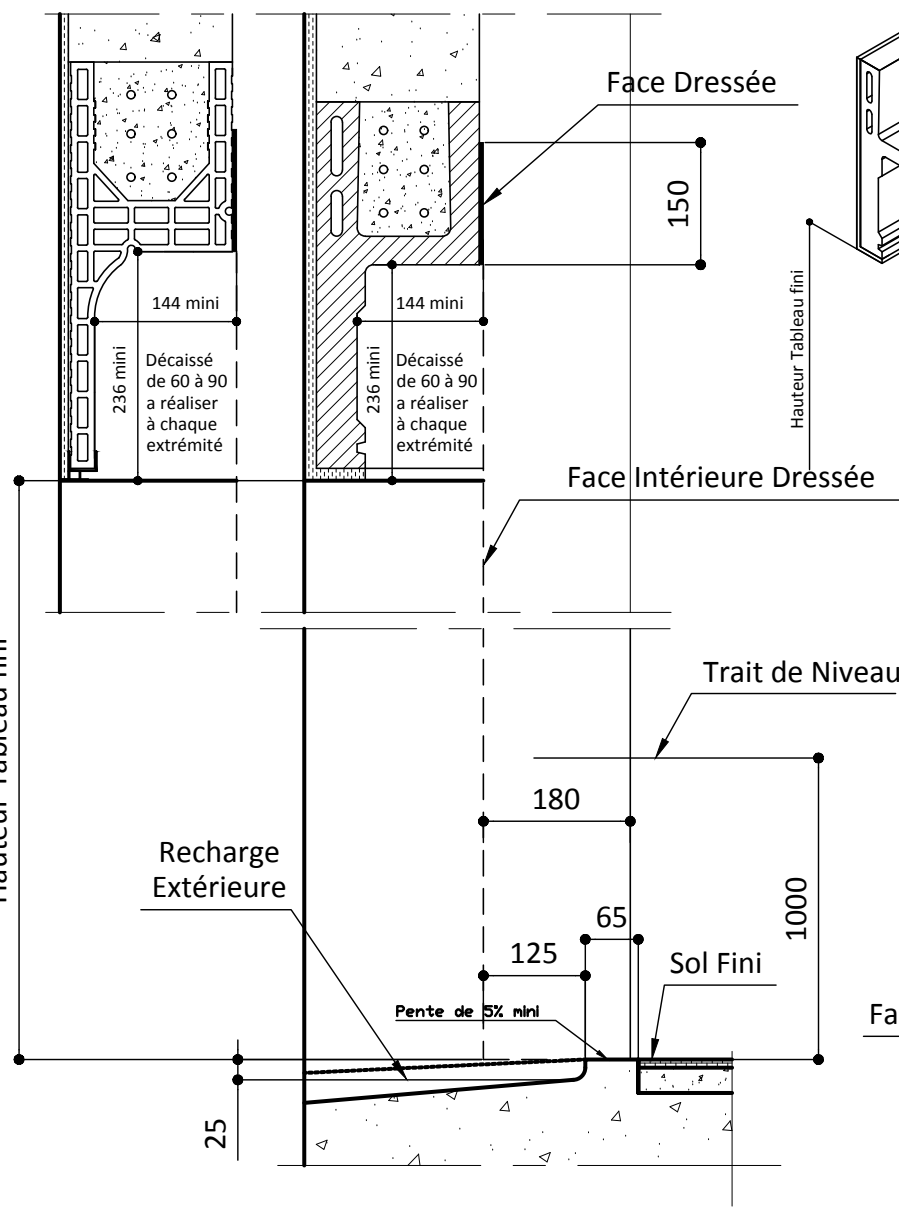

SEUIL PMR

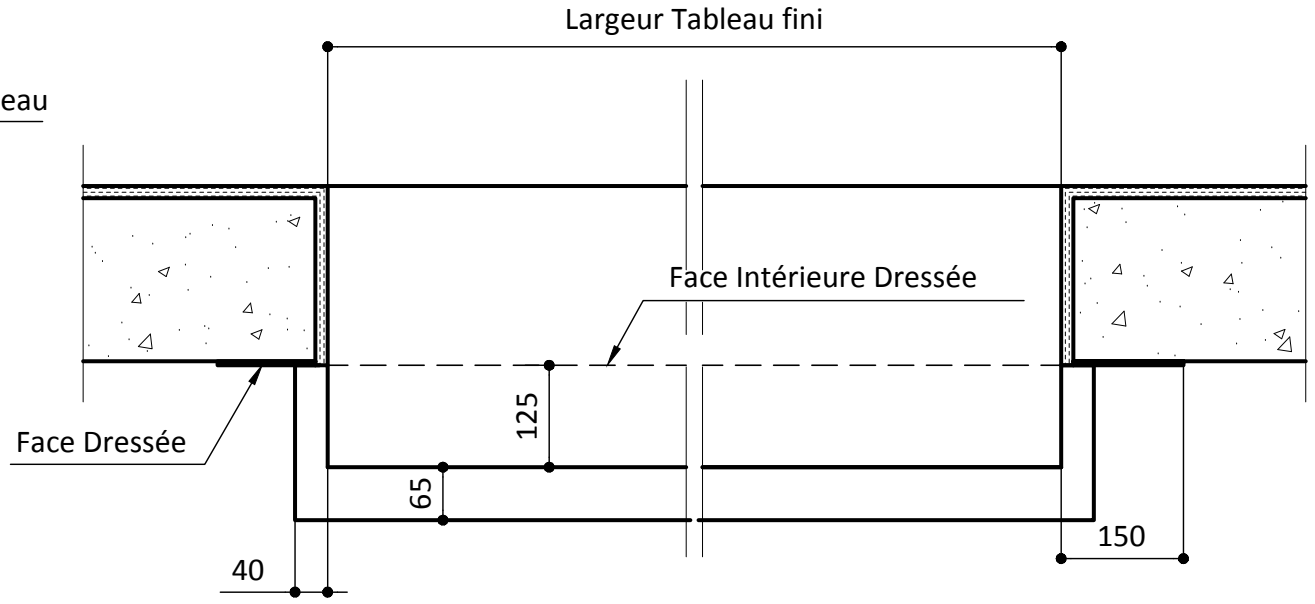

Désignation du plan : FRAPPE SEUIL PMR - POSE 1D180 VR OPTIBAIE (pose dans demi-linteau)	
Fichier : ResaCAIB_Pvc_P1.dwg	
Des. : M.CHAUVIERE	Ech : 1 / 10 EE11
Date : 09/01/2018	N° : 10596

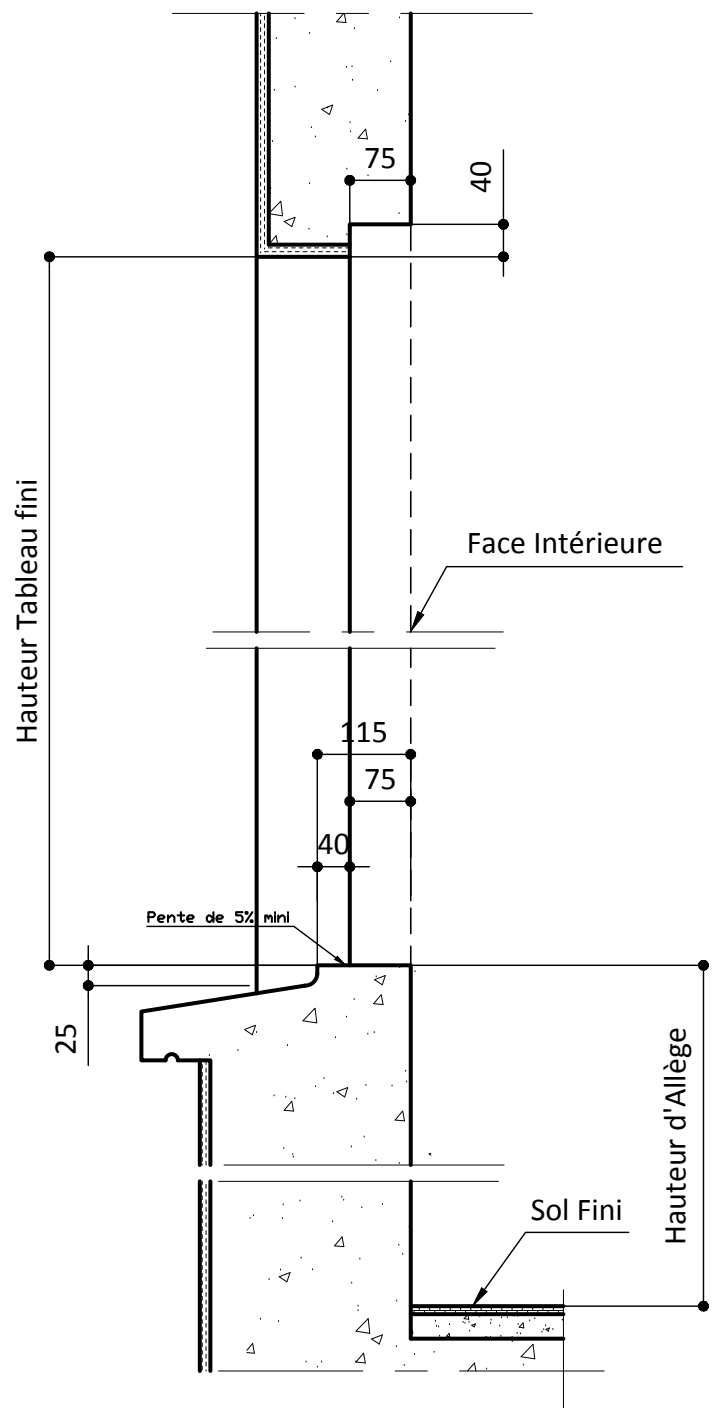

REPÈRE	TABLEAU FINI		SENS D'OUVERTURE	VITRAGE EXT / INT	OBSERVATIONS	QTE
	HAUTEUR	LARGEUR				

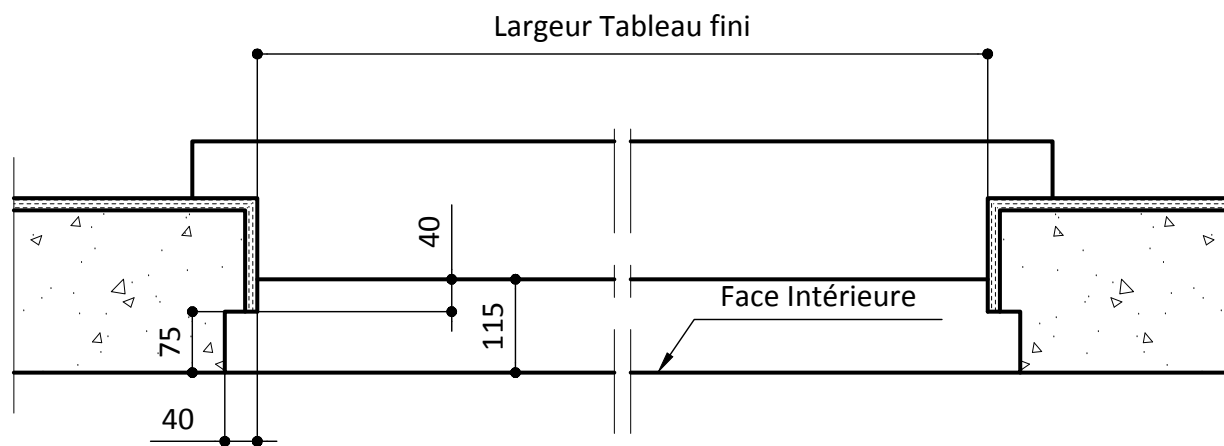

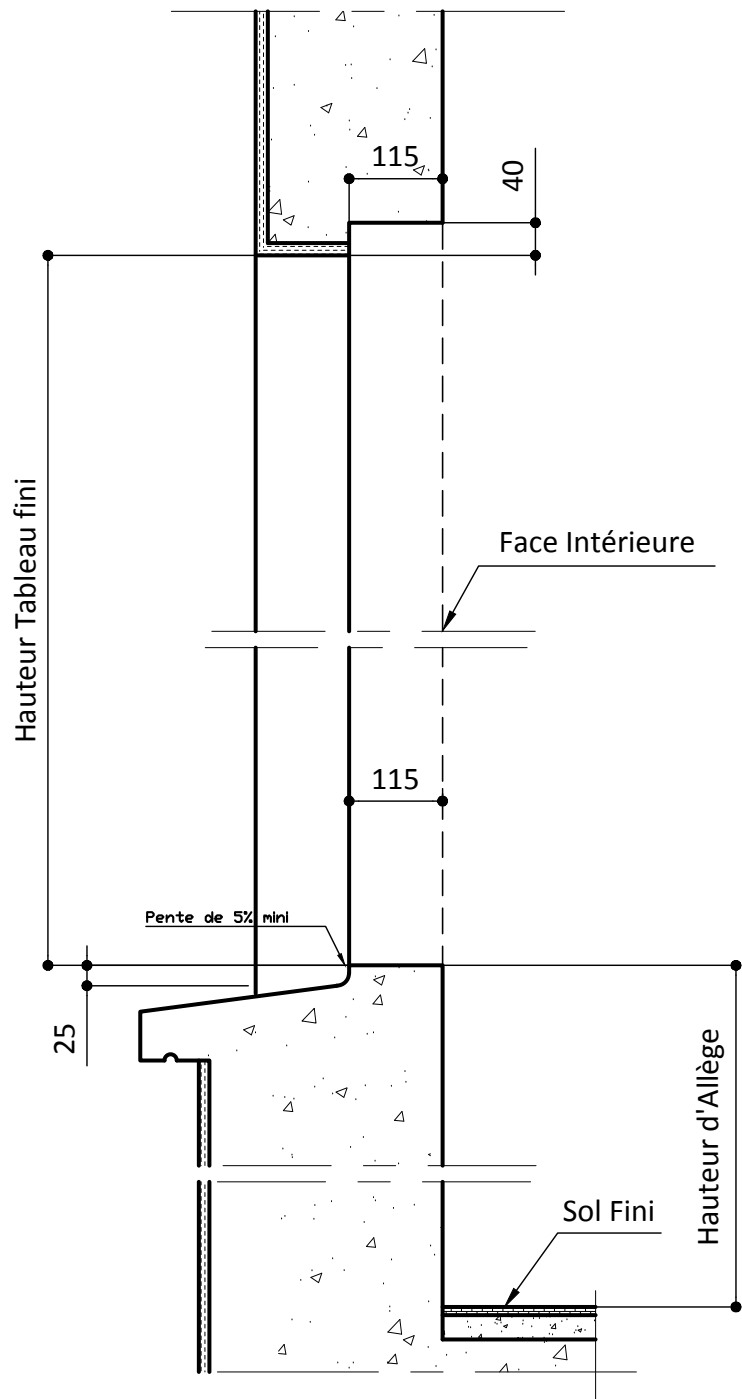

Désignation du plan :
FRAPPE SUR ALLEGE - POSE FEUILLURE
SANS RECOUVREMENT-SANS VR

Fichier : ResaCAIB_Pvc_P1.dwg
Des. : M.CHAUVIERE Ech : 1 / 10 A1
Date : 09/01/2018 N° : 12001

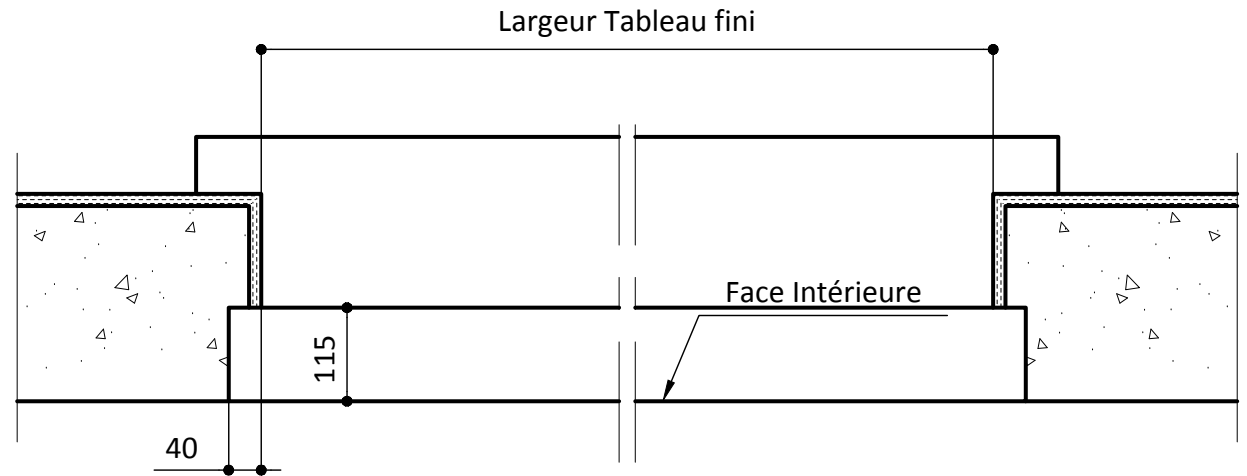

REPÈRE	TABLEAU FINI		SENS D'OUVERTURE	VITRAGE EXT / INT	OBSERVATIONS	QTE
	HAUTEUR	LARGEUR				



 	Désignation du plan : FRAPPE SUR ALLEGE - POSE FEUILLURE SANS RECOUVREMENT-AVEC VR	
	Fichier : ResaCAIB_Pvc_P1.dwg	
	Des. : M.CHAUVIERE	Ech : 1 / 10 B1
	Date : 09/01/2018	N° : 12006

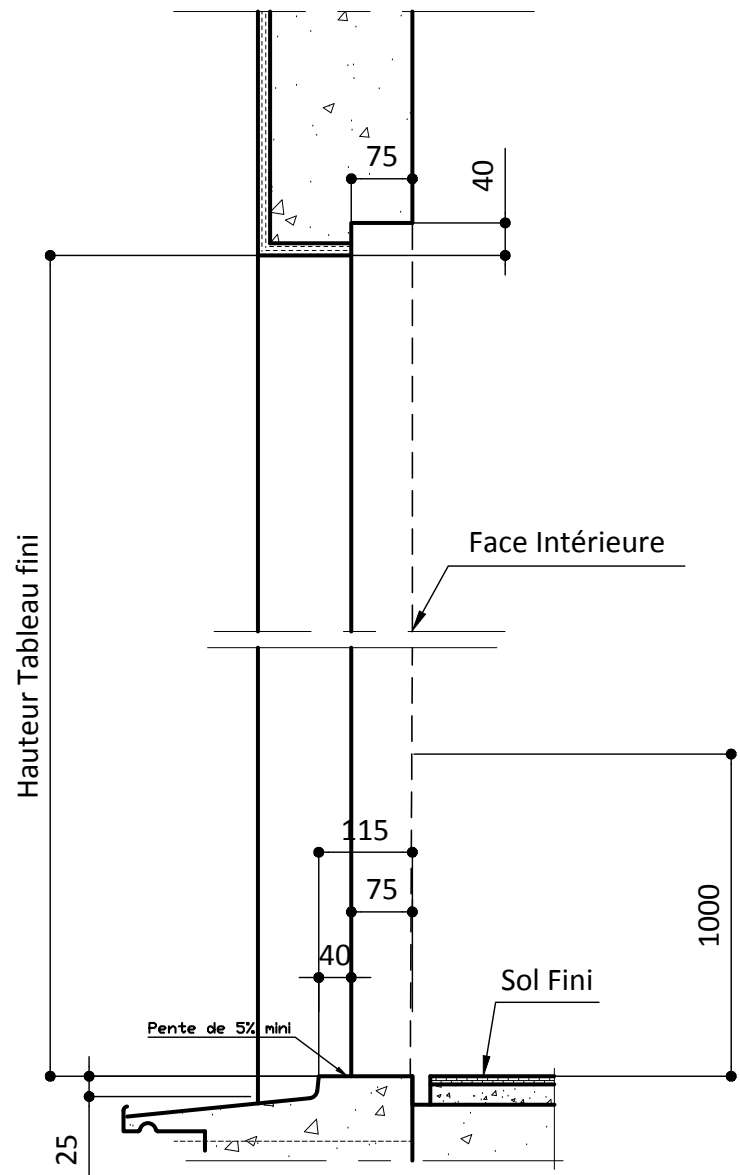

REPERE	TABLEAU FINI		SENS D'OUVERTURE	VITRAGE EXT / INT	OBSERVATIONS	QTE
	HAUTEUR	LARGEUR				

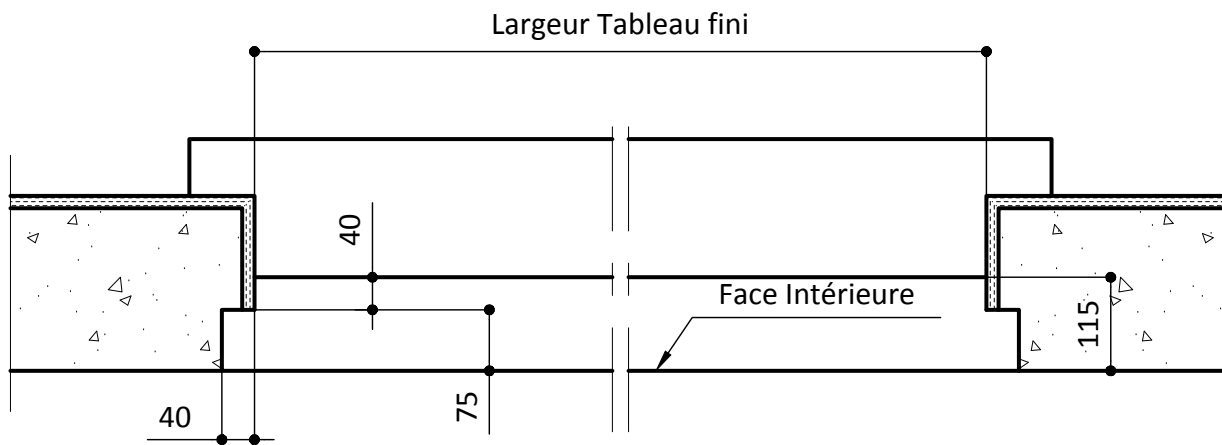

Désignation du plan :
 FRAPPE SUR SOL FINI - POSE FEUILLURE
 SANS RECOUVREMENT-SANS VR

Fichier : ResaCAIB_Pvc_P1.dwg

Des. : M.CHAUVIERE Ech : 1 / 10 D1

Date : 09/01/2018 N° : 12016

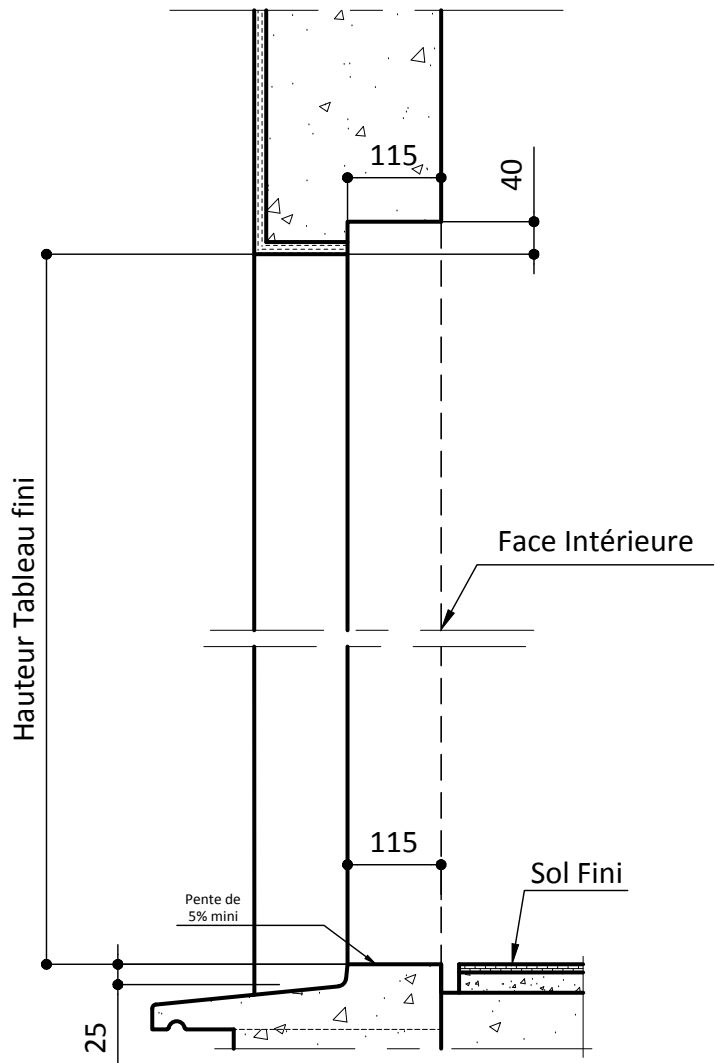

REPÈRE	TABLEAU FINI		SENS D'OUVERTURE	VITRAGE EXT / INT	OBSERVATIONS	QTE
	HAUTEUR	LARGEUR				

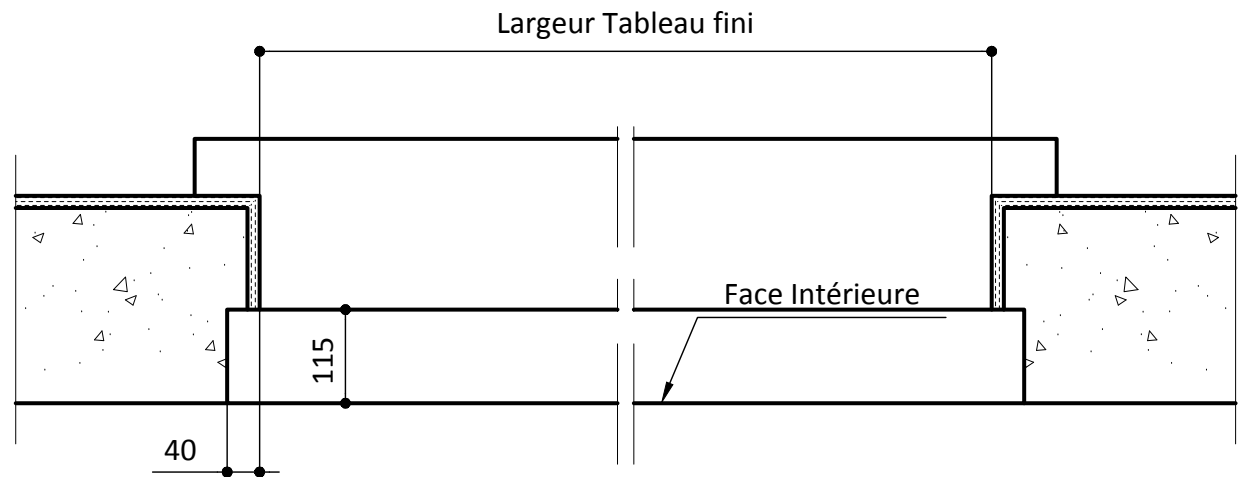

Désignation du plan :
 FRAPPE SUR SOL FINI - POSE FEUILLURE
 SANS RECOUVREMENT-AVEC VR

Fichier : ResaCAIB_Pvc_P1.dwg

Des. : M.CHAUVIERE Ech : 1 / 10 E1

Date : 09/01/2018 N° : 12021

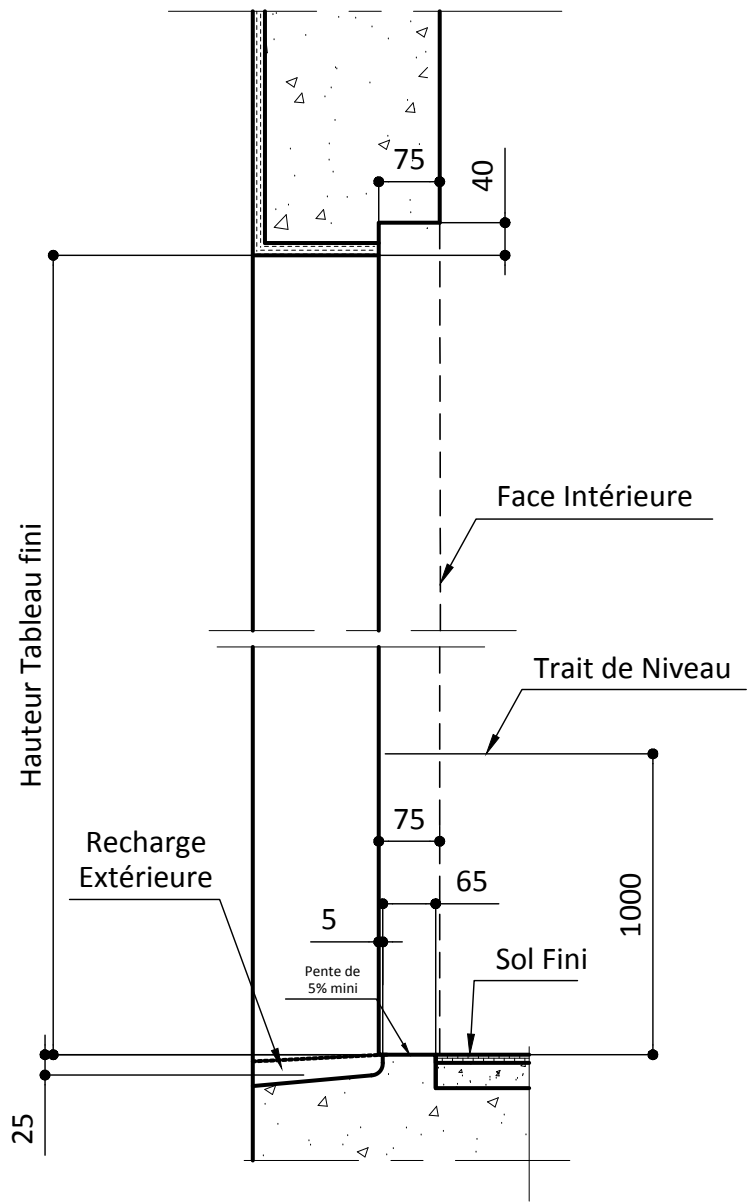

SEUIL PMR

REPÈRE	TABLEAU FINI		SENS D'OUVERTURE	VITRAGE EXT / INT	OBSERVATIONS	QTE
	HAUTEUR	LARGEUR				

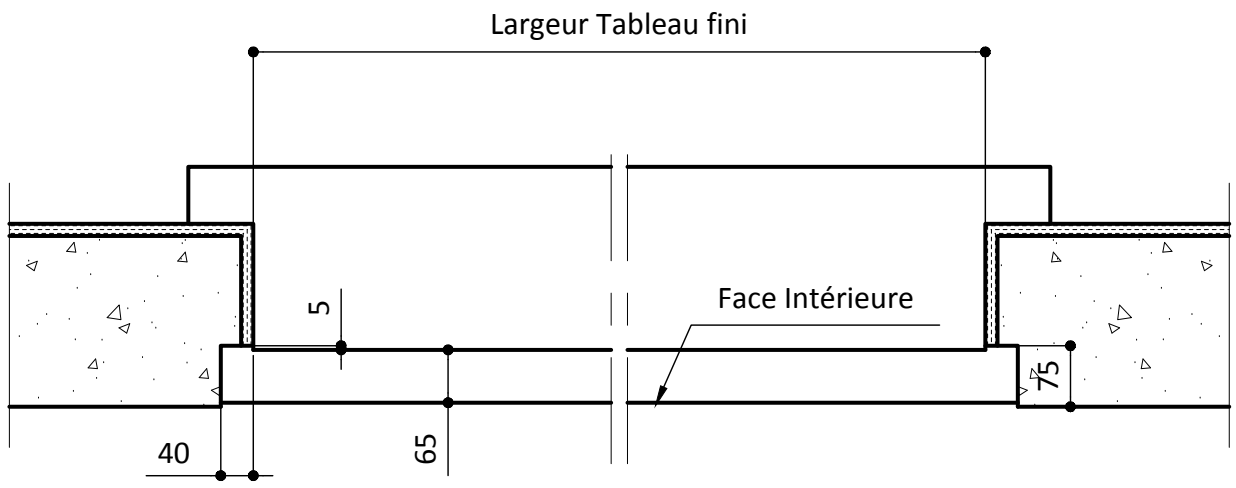

Désignation du plan :
 FRAPPE SEUIL PMR - POSE FEUILLE
 SANS RECOUVREMENT-SANS VR

Fichier : ResaCAIB_Pvc_P1.dwg

Des. : M.CHAUVIERE Ech : 1 / 10 J1

Date : 09/01/2018 N° : 12046

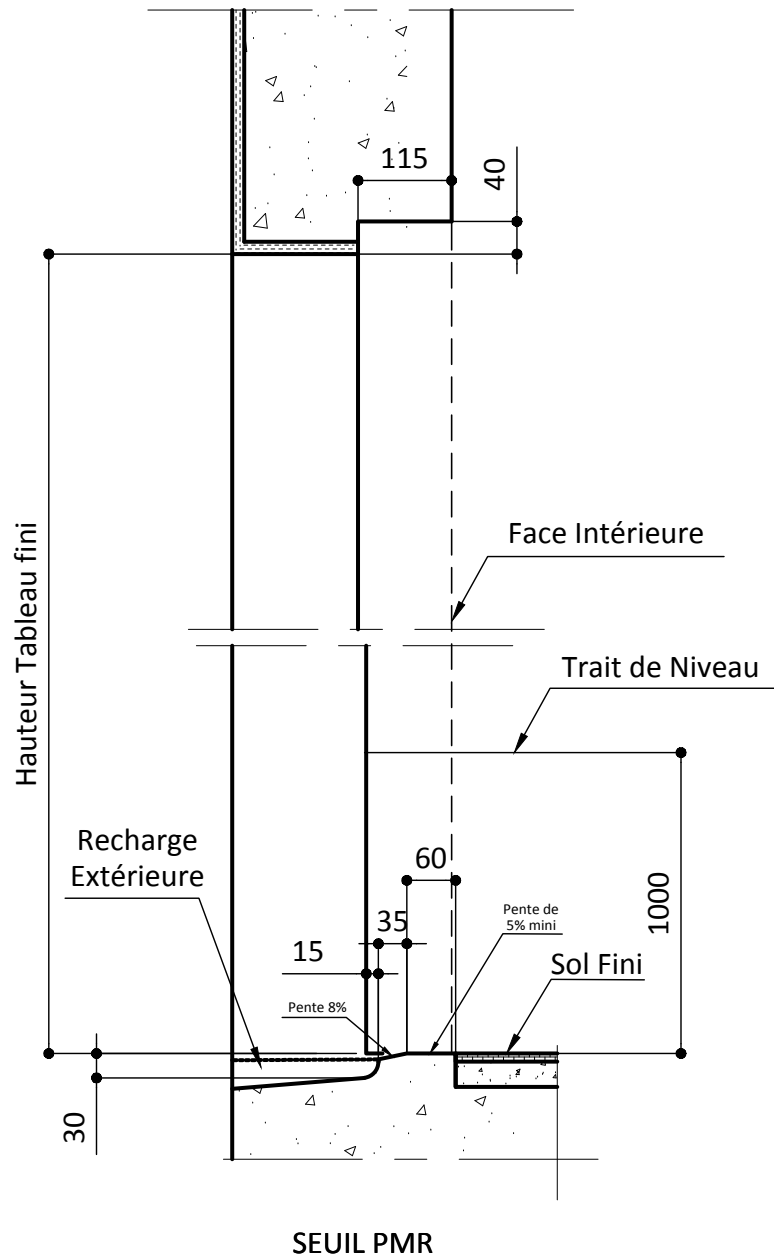

REPERE	TABLEAU FINI		SENS D'OUVERTURE	VITRAGE EXT / INT	OBSERVATIONS	QTE
	HAUTEUR	LARGEUR				

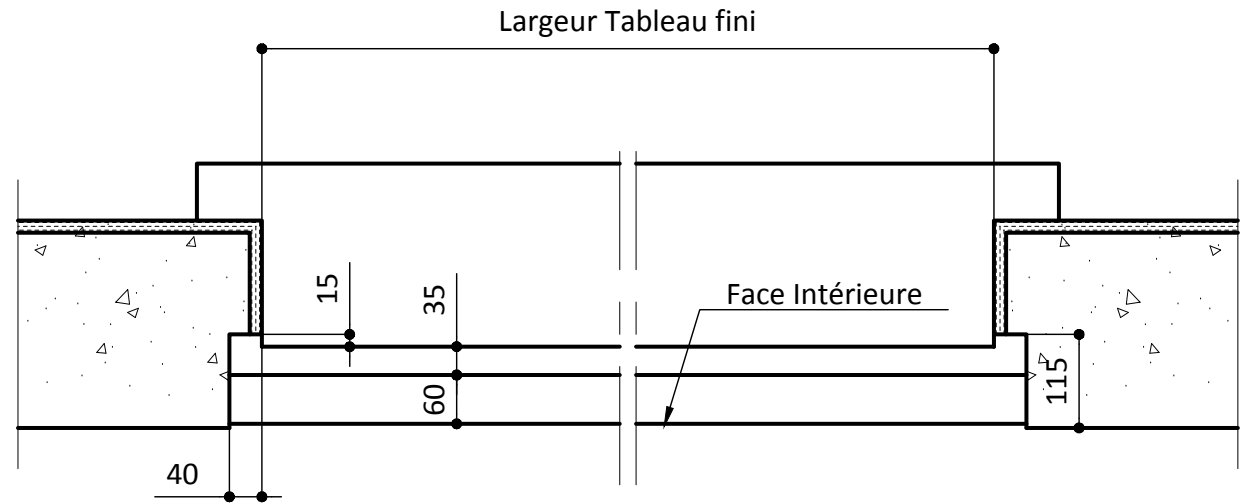

Désignation du plan :
FRAPPE SEUIL PMR - POSE FEUILLE
SANS RECOUVREMENT-AVEC VR

Fichier : ResaCAIB_Pvc_P1.dwg
Des. : M.CHAUVIERE Ech : 1 / 10 K1
Date : 09/01/2018 N° : 12051

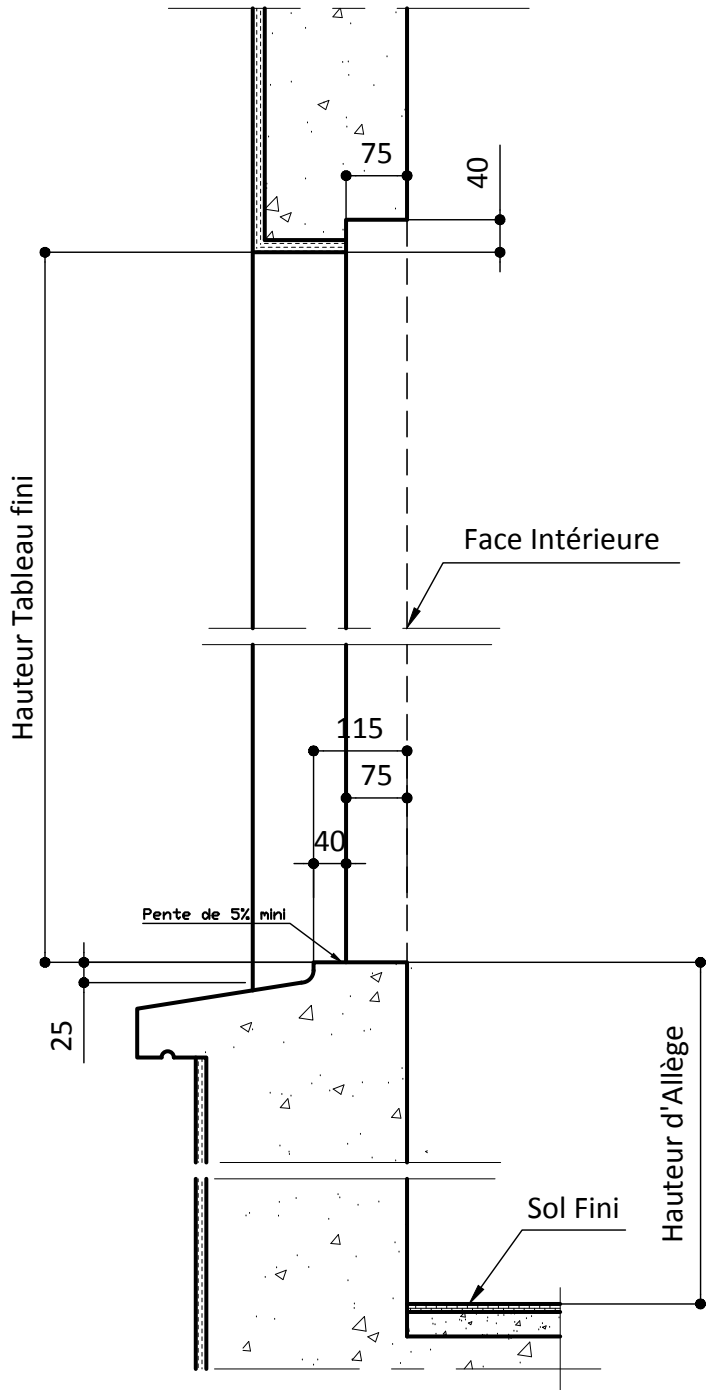

REPERE	TABLEAU FINI		SENS D'OUVERTURE	VITRAGE EXT / INT	OBSERVATIONS	QTE
	HAUTEUR	LARGEUR				

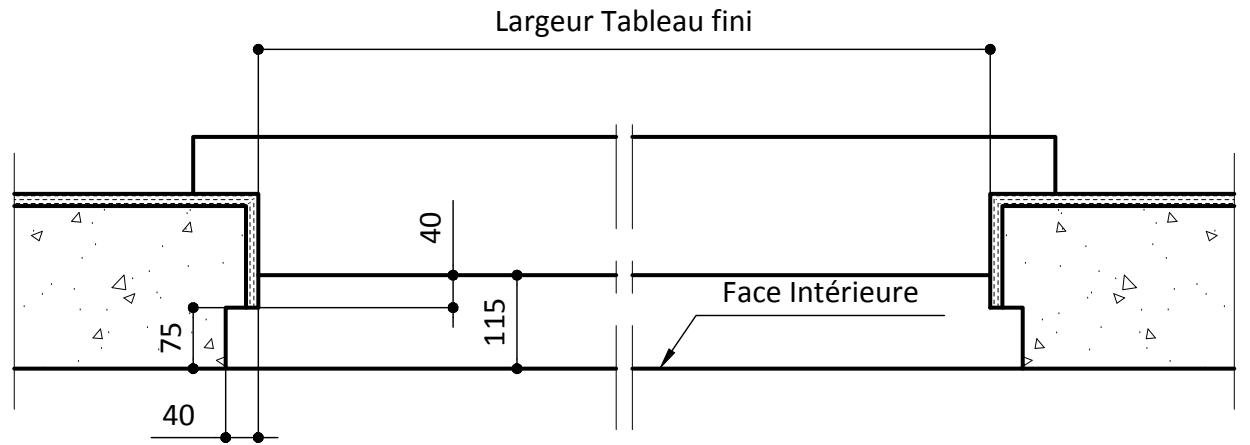

Désignation du plan : FRAPPE SUR ALLEGE - POSE FEUILLURE SANS RECOUVREMENT-SANS VR	
Fichier : ResaCAIB_Pvc_P1.dwg	
Des. : M.CHAUVIERE	Ech : 1 / 10 M1
Date : 09/01/2018	N° : 12061

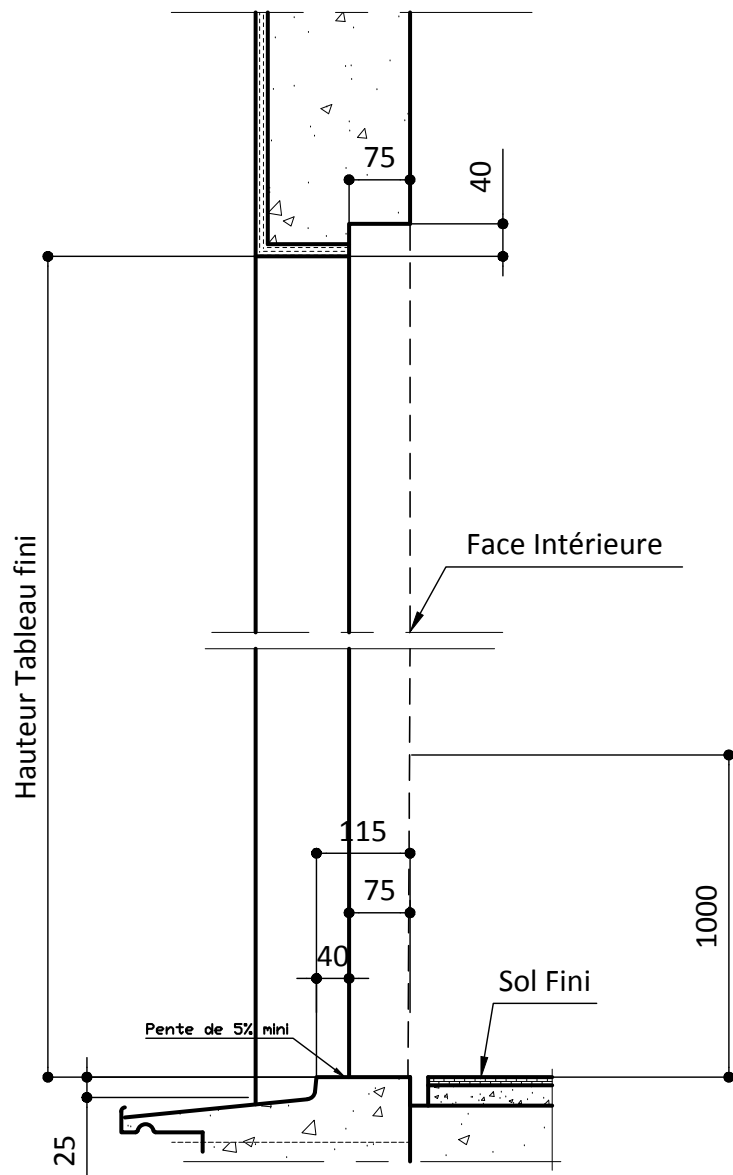

REPERE	TABLEAU FINI		SENS D'OUVERTURE	VITRAGE EXT / INT	OBSERVATIONS	QTE
	HAUTEUR	LARGEUR				

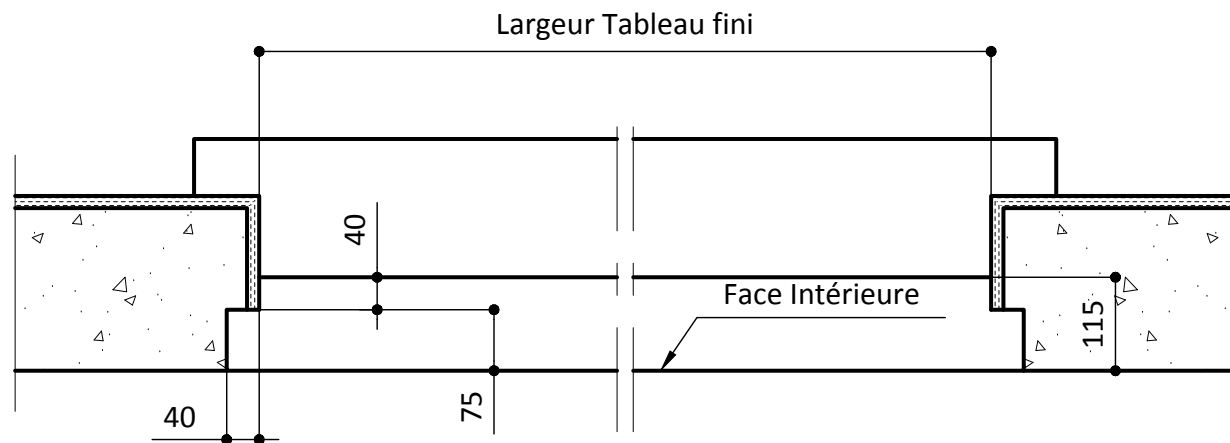

Désignation du plan :
 FRAPPE SUR SOL FINI - POSE FEUILLURE
 SANS RECOUVREMENT-SANS VR

Fichier : ResaCAIB_Pvc_P1.dwg

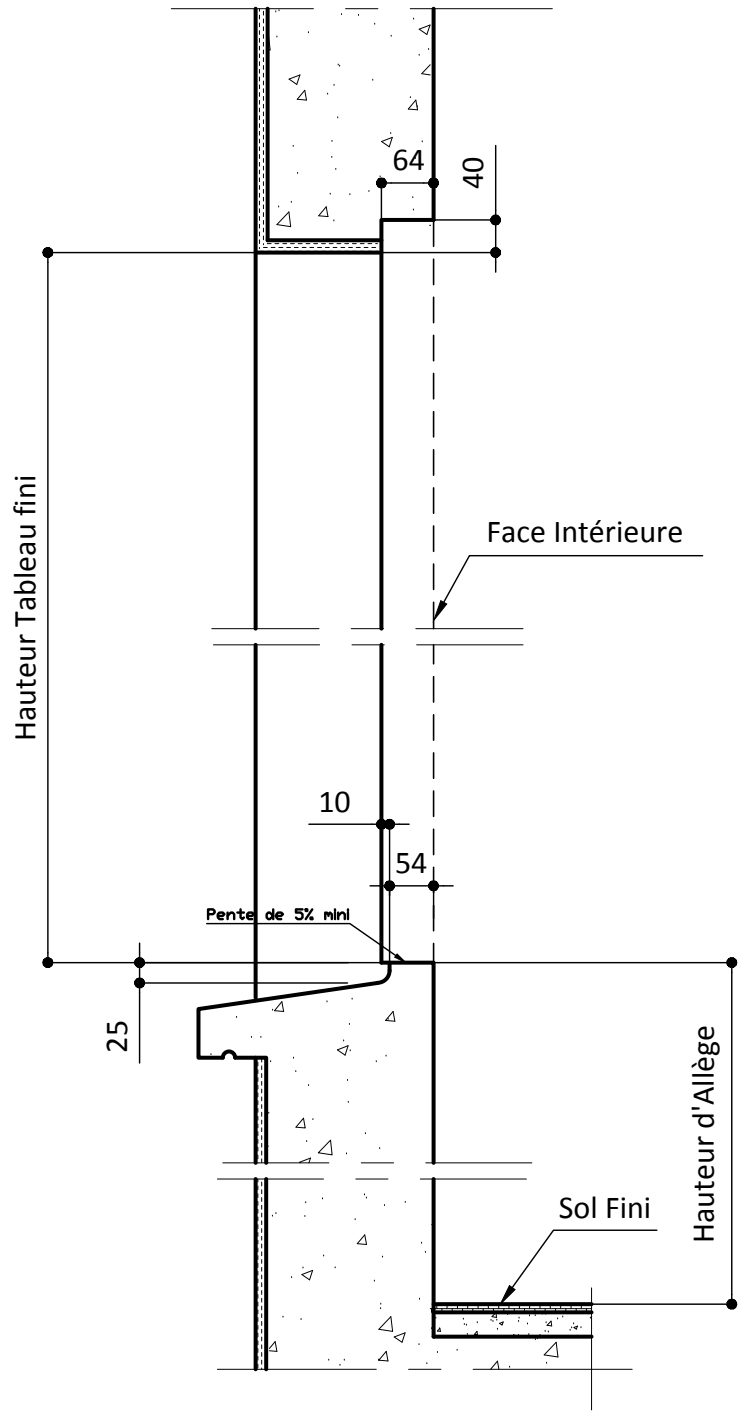

Des. : M.CHAUVIERE Ech : 1 / 10 P1

Date : 09/01/2018 N° : 12076

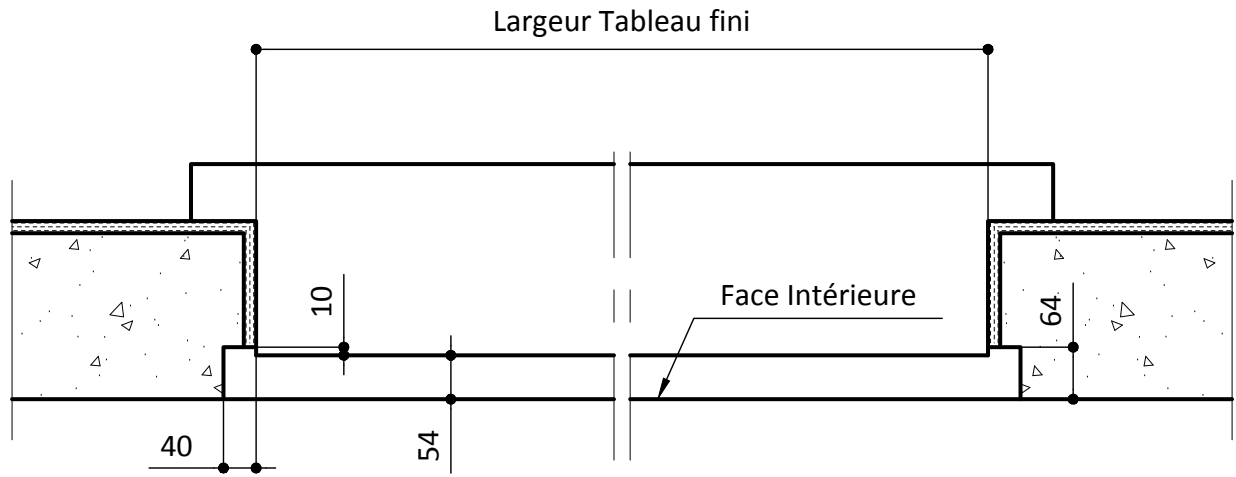

REPÈRE	TABLEAU FINI		SENS D'OUVERTURE	VITRAGE EXT / INT	OBSERVATIONS	QTE
	HAUTEUR	LARGEUR				



 	Désignation du plan : FRAPPE SUR ALLEGE - POSE FEUILLURE AVEC RECOUVEREMENT-SANS VR	
	Fichier : ResaCAIB_Pvc_P1.dwg	
	Des. : M.CHAUVIERE	Ech : 1 / 10 A2
	Date : 09/01/2018	N° : 12096

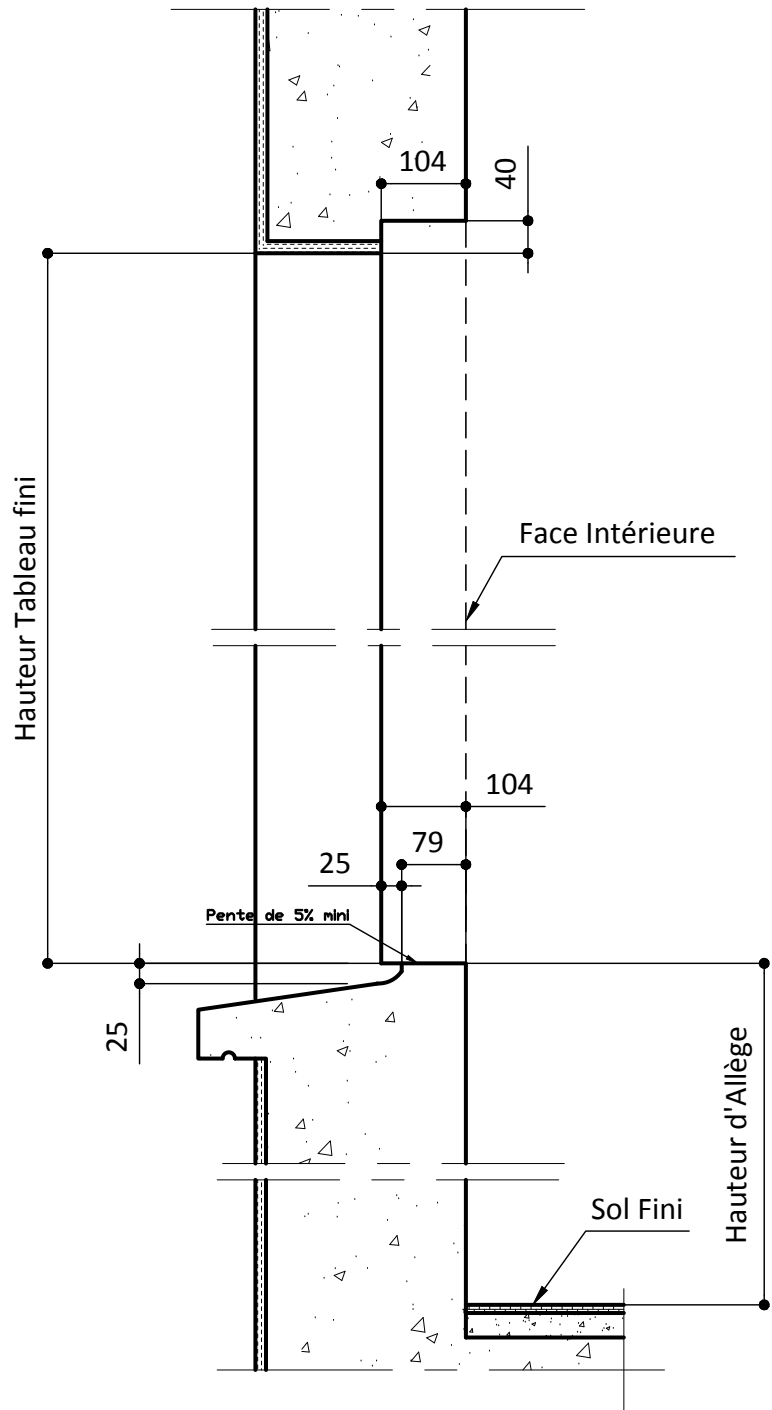

REPÈRE	TABLEAU FINI		SENS D'OUVERTURE	VITRAGE EXT / INT	OBSERVATIONS	QTE
	HAUTEUR	LARGEUR				

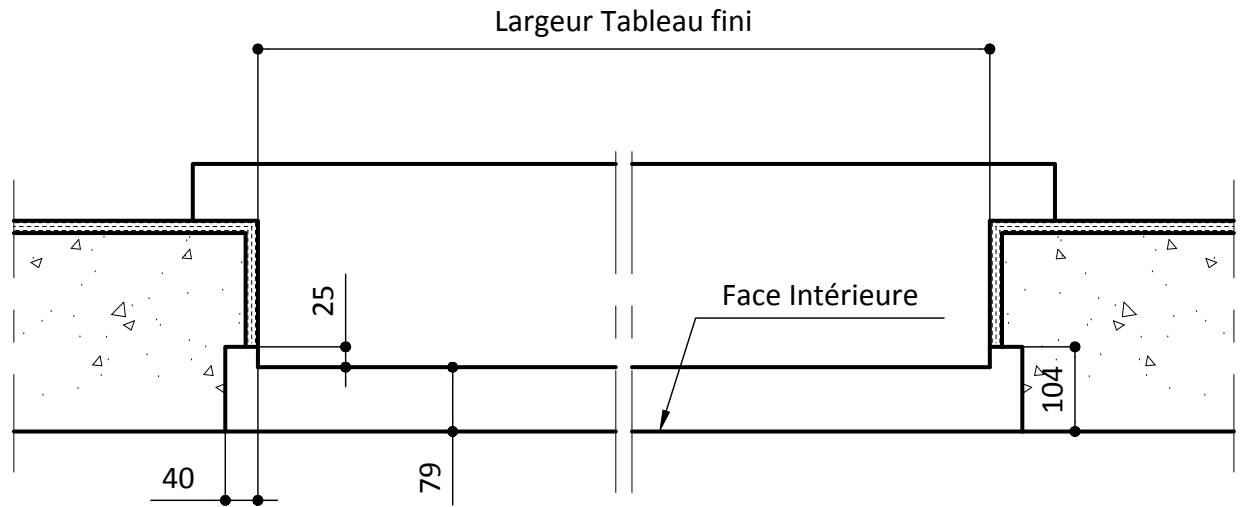

Désignation du plan :
FRAPPE SUR ALLEGE - POSE FEUILLURE
AVEC RECOUVERMENT - VR EVIBAIE

Fichier : ResaCAIB_Pvc_P1.dwg

Des. : M.CHAUVIERE Ech : 1 / 10 B2

Date : 09/01/2018 N° : 12101

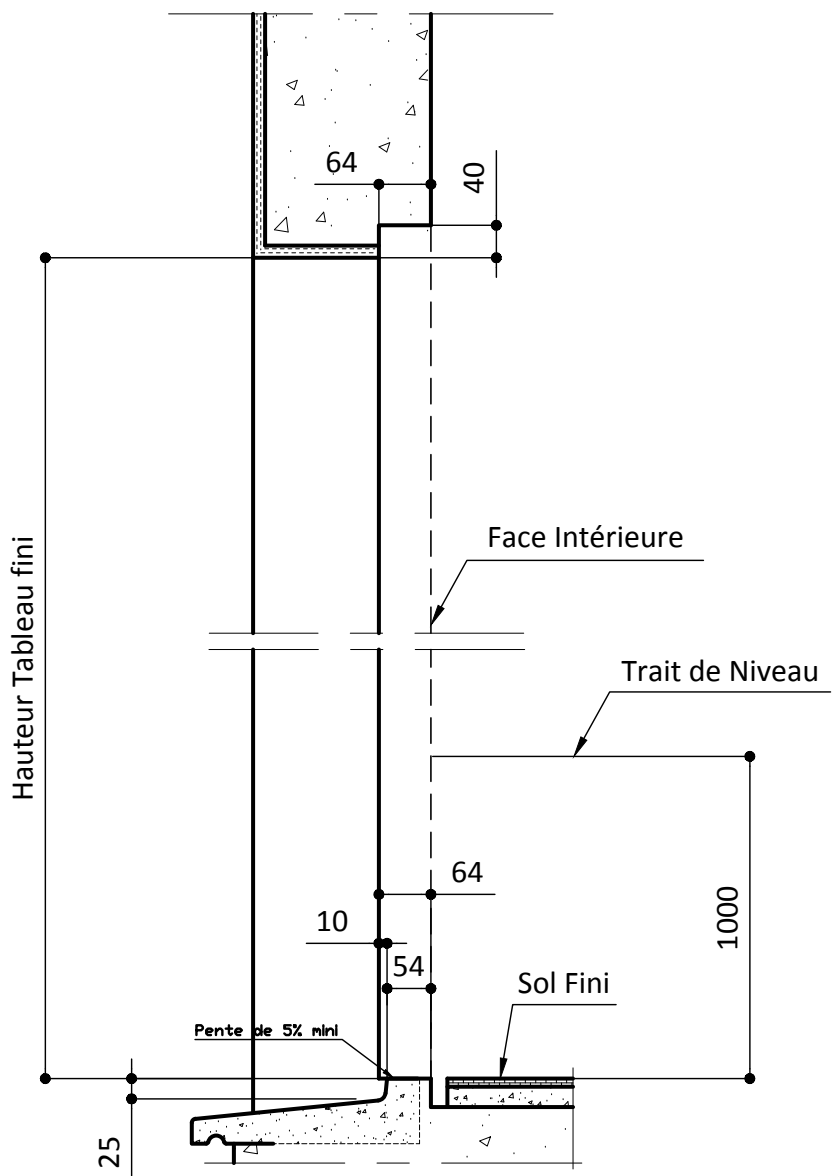

SEUIL STANDARD

REPÈRE	TABLEAU FINI		SENS D'OUVERTURE	VITRAGE EXT / INT	OBSERVATIONS	QTE
	HAUTEUR	LARGEUR				

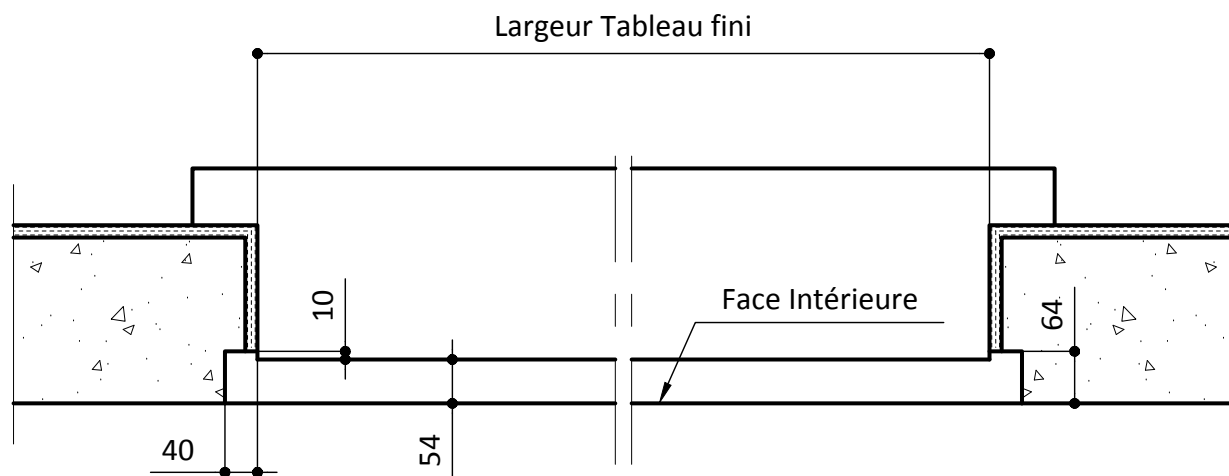

Désignation du plan :
 FRAPPE SUR SOL FINI-POSE FEUILLURE
 AVEC RECOUVREMENT-SANS VR

Fichier : ResaCAIB_Pvc_P1.dwg

Des. : M.CHAUVIERE Ech : 1 / 10 D2

Date : 09/01/2018 N° : 12111

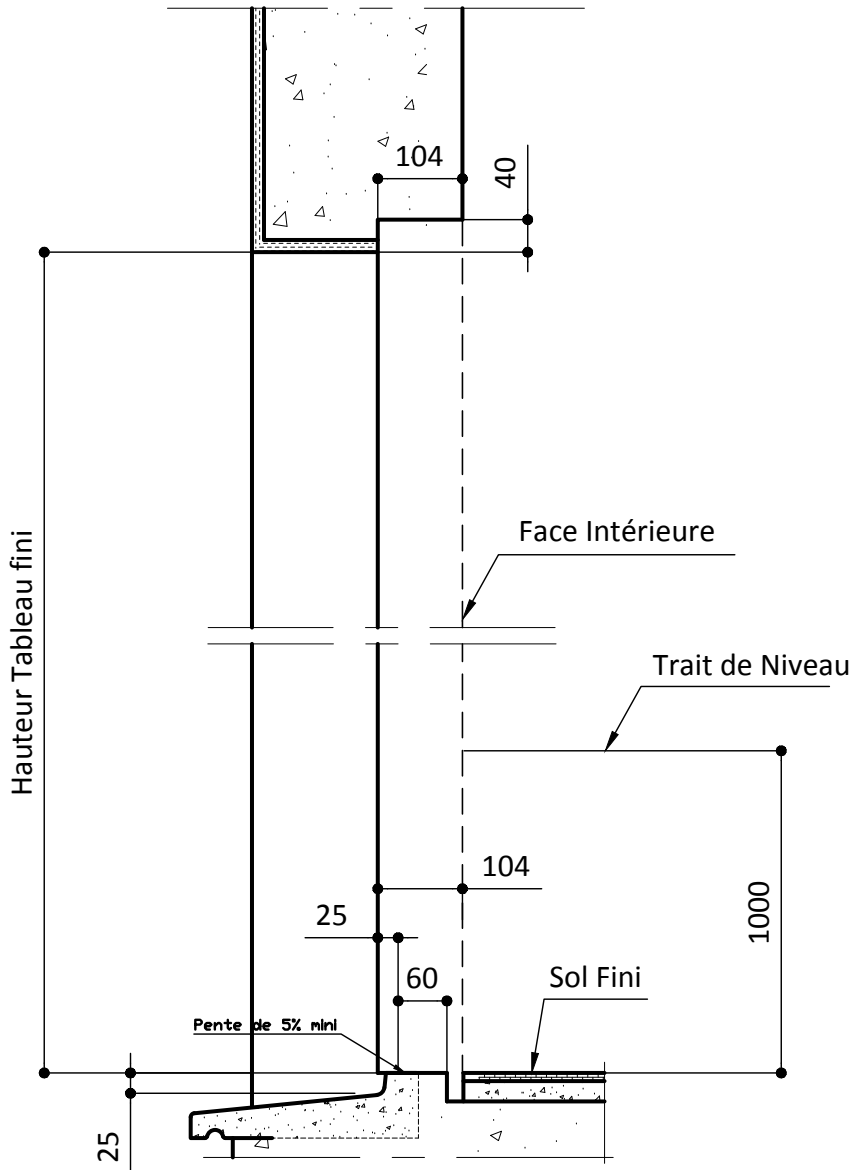

SEUIL STANDARD

REPERE	TABLEAU FINI		SENS D'OUVERTURE	VITRAGE EXT / INT	OBSERVATIONS	QTE
	HAUTEUR	LARGEUR				

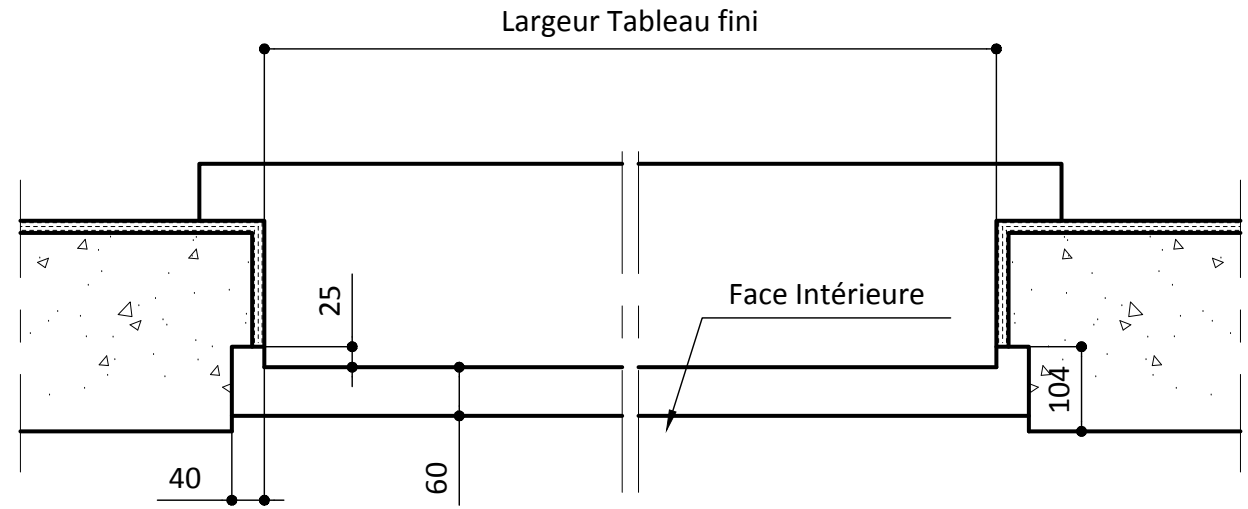

Désignation du plan :
 FRAPPE SUR SOL FINI-POSE FEUILLURE
 AVEC RECOUVREMENT - VR EVIBAIE

Fichier : ResaCAIB_Pvc_P1.dwg

Des. : M.CHAUVIERE Ech : 1 / 10 E2

Date : 09/01/2018 N° : 12116

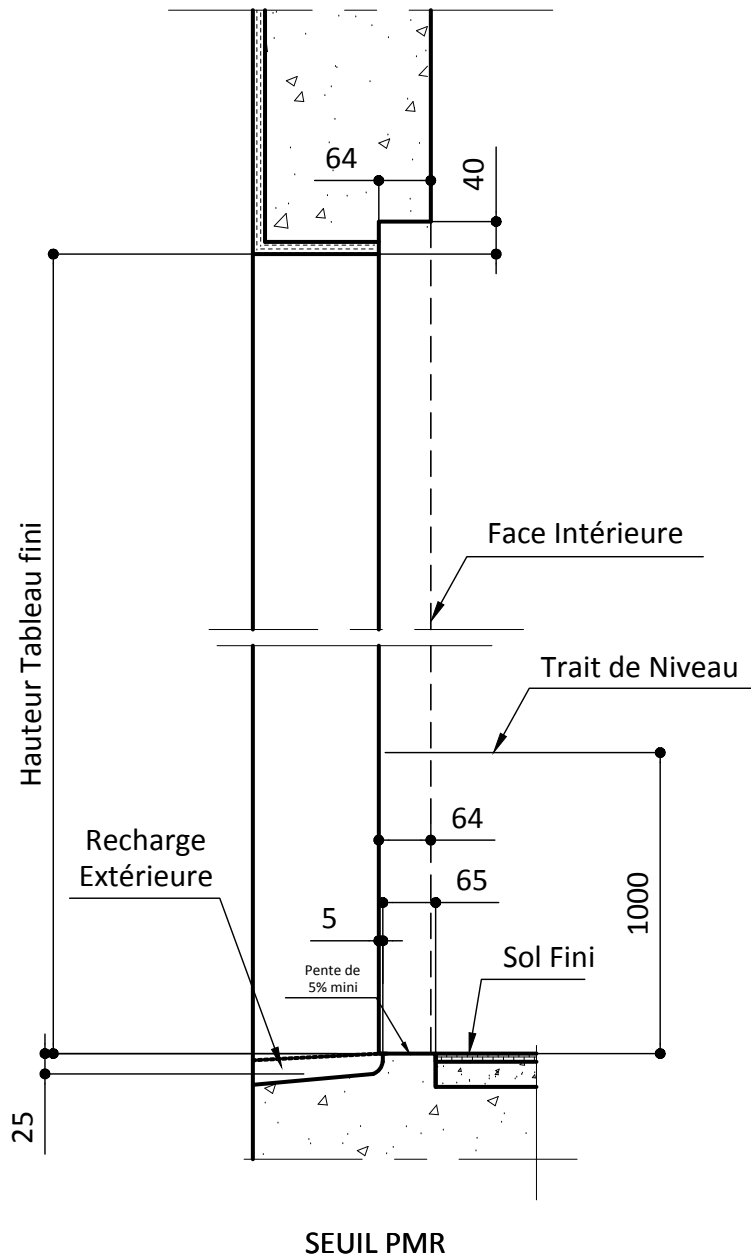

REPÈRE	TABLEAU FINI		SENS D'OUVERTURE	VITRAGE EXT / INT	OBSERVATIONS	QTE
	HAUTEUR	LARGEUR				

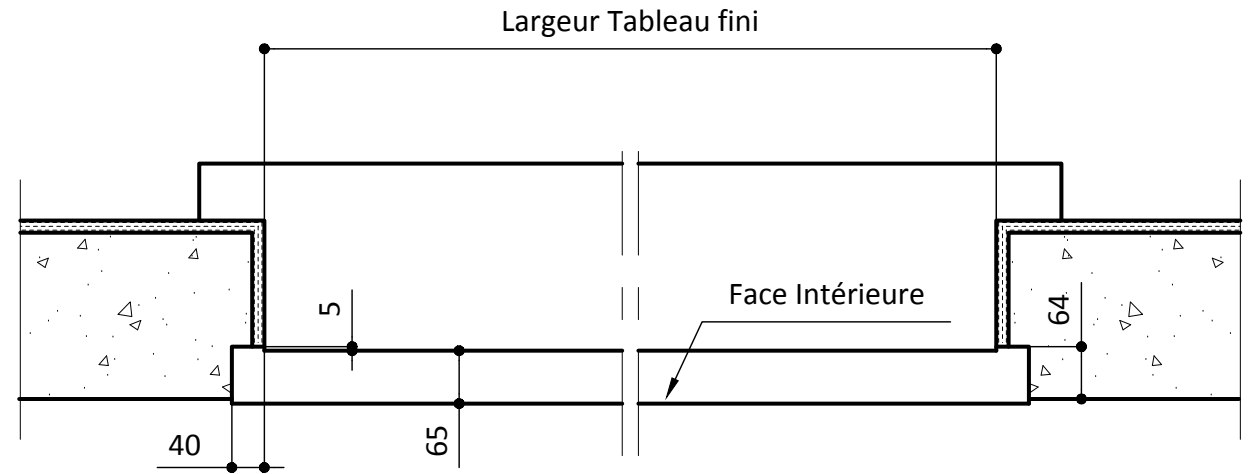

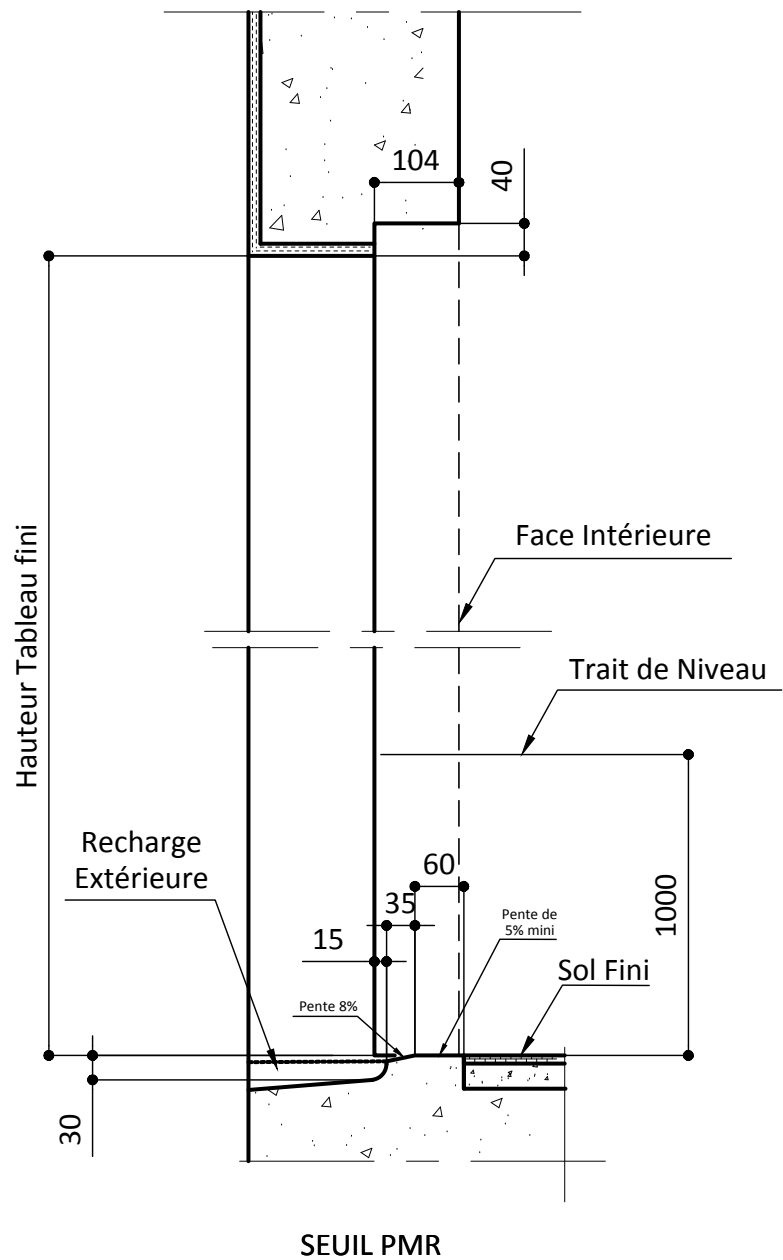

Désignation du plan :
FRAPPE SEUIL PMR - POSE FEUILLE
AVEC RECOUVREMENT-SANS VR

Fichier : ResaCAIB_Pvc_P1.dwg
Des. : M.CHAUVIERE Ech : 1 / 10 J2
Date : 09/01/2018 N° : 12141

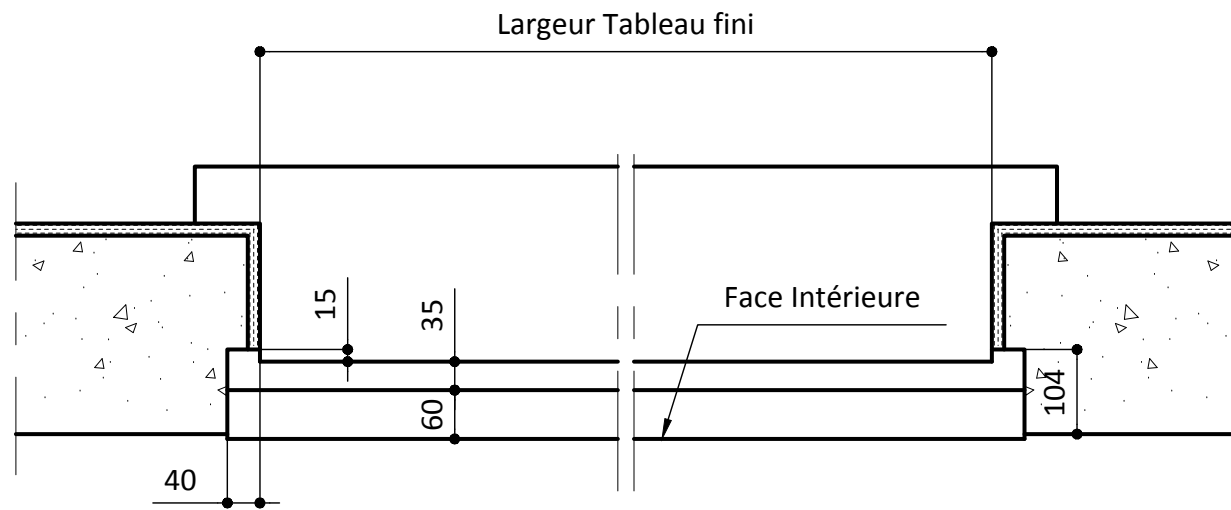

REPÈRE	TABLEAU FINI		SENS D'OUVERTURE	VITRAGE EXT / INT	OBSERVATIONS	QTE
	HAUTEUR	LARGEUR				



 	Désignation du plan : FRAPPE SEUIL PMR - POSE FEUILLEURE AVEC RECOUVREMENT - VR EVIBAIE	
	Fichier : ResaCAIB_Pvc_P1.dwg	
	Des. : M.CHAUVIERE	Ech : 1 / 10 K2
	Date : 09/01/2018	N° : 12146

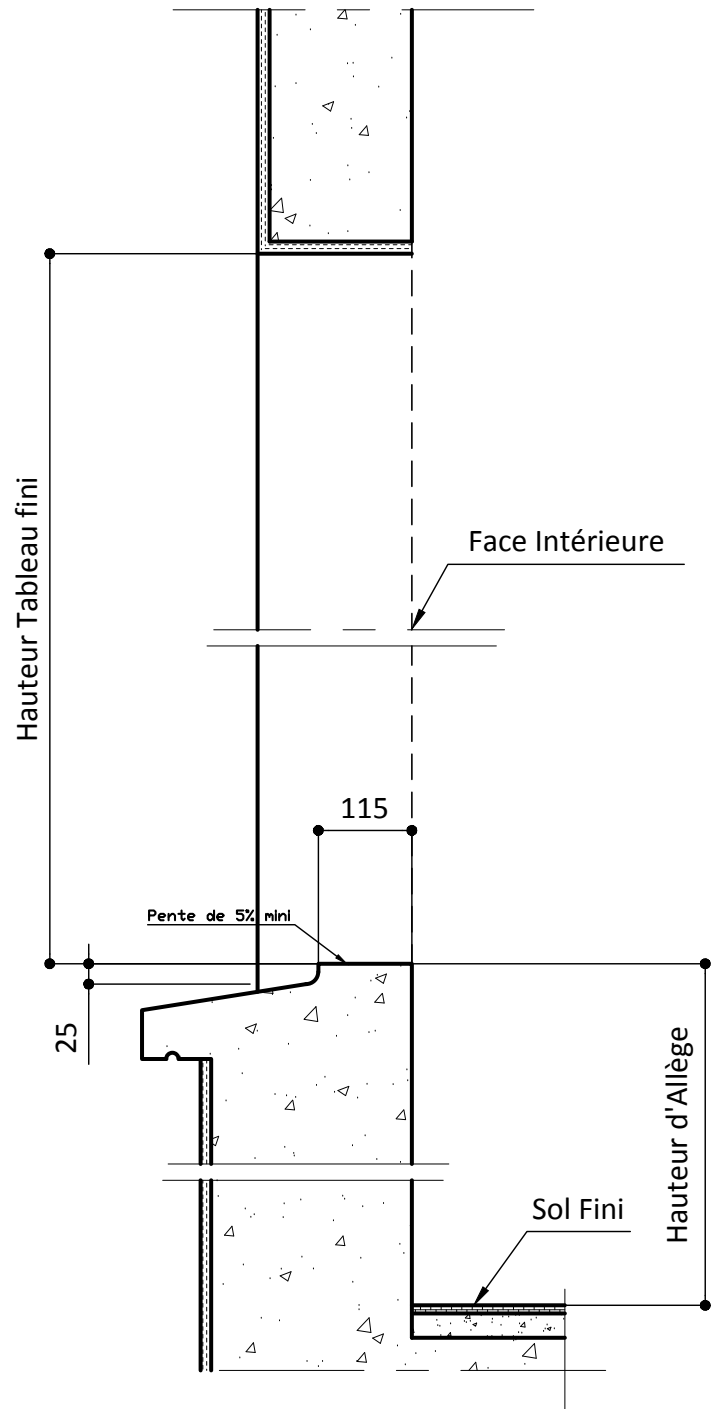

REPERE	TABLEAU FINI		SENS D'OUVERTURE	VITRAGE EXT / INT	OBSERVATIONS	QTE
	HAUTEUR	LARGEUR				

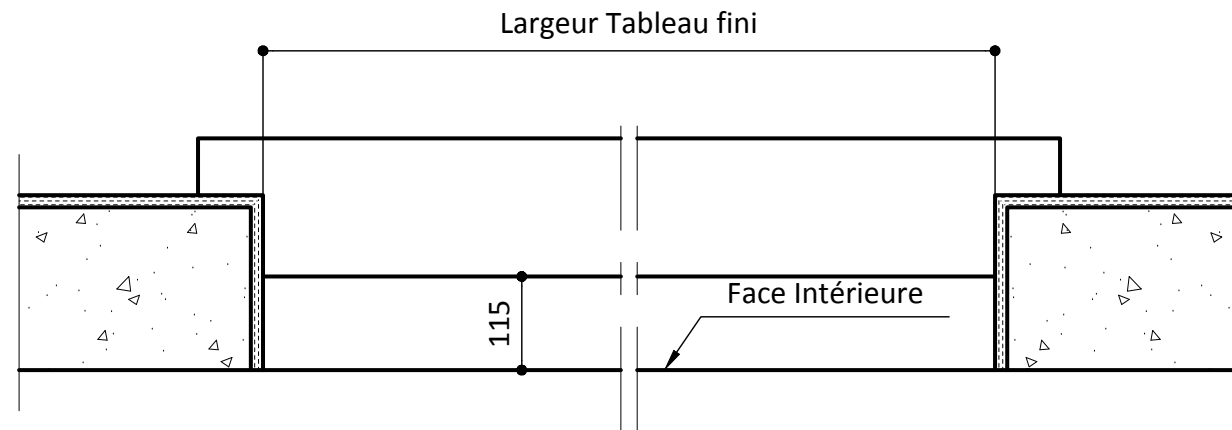

Désignation du plan :
 FRAPPE SUR ALLEGE - POSE TUNNEL
 SANS RECOUVREMENT-SANS VR

Fichier : ResaCAIB_Pvc_P1.dwg

Des. : M.CHAUVIERE Ech : 1 / 10 A3

Date : 09/01/2018 N° : 12181

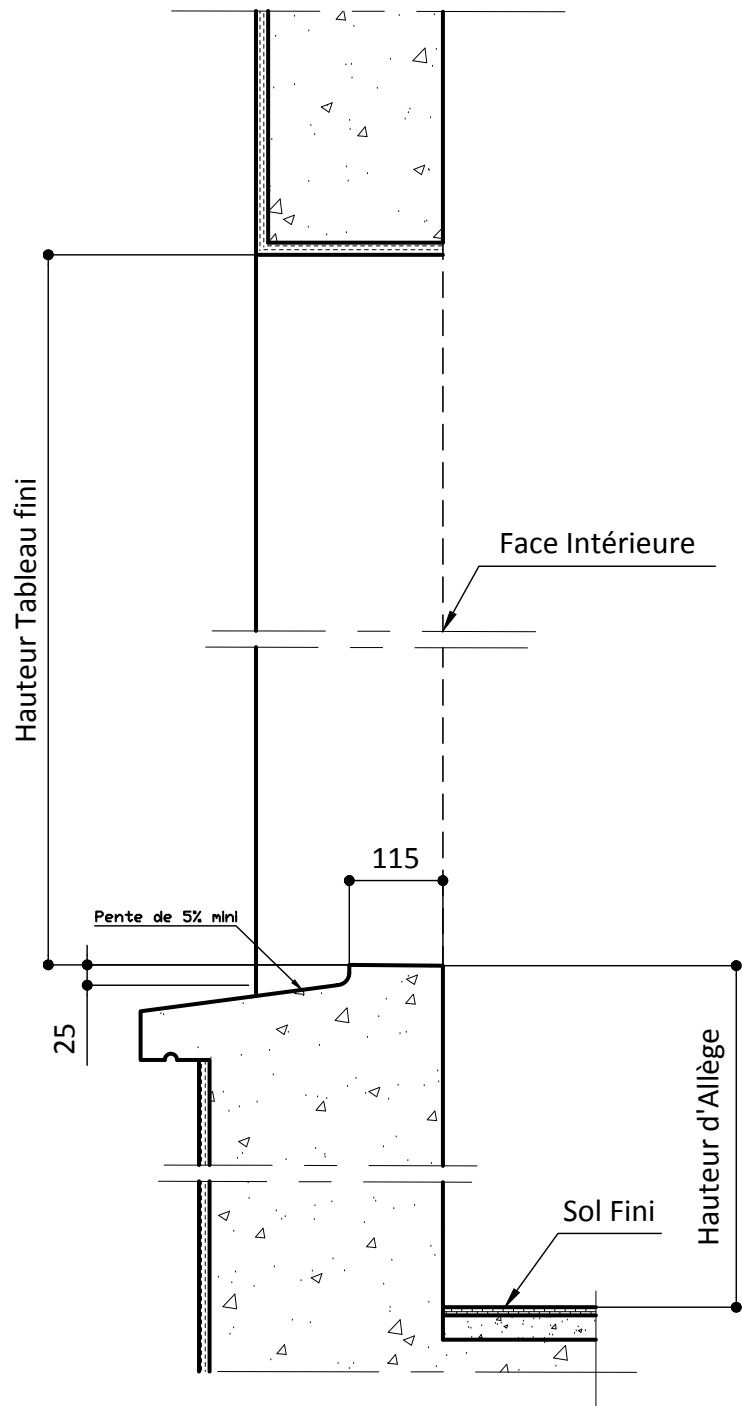

REPÈRE	TABLEAU FINI		SENS D'OUVERTURE	VITRAGE EXT / INT	OBSERVATIONS	QTE
	HAUTEUR	LARGEUR				

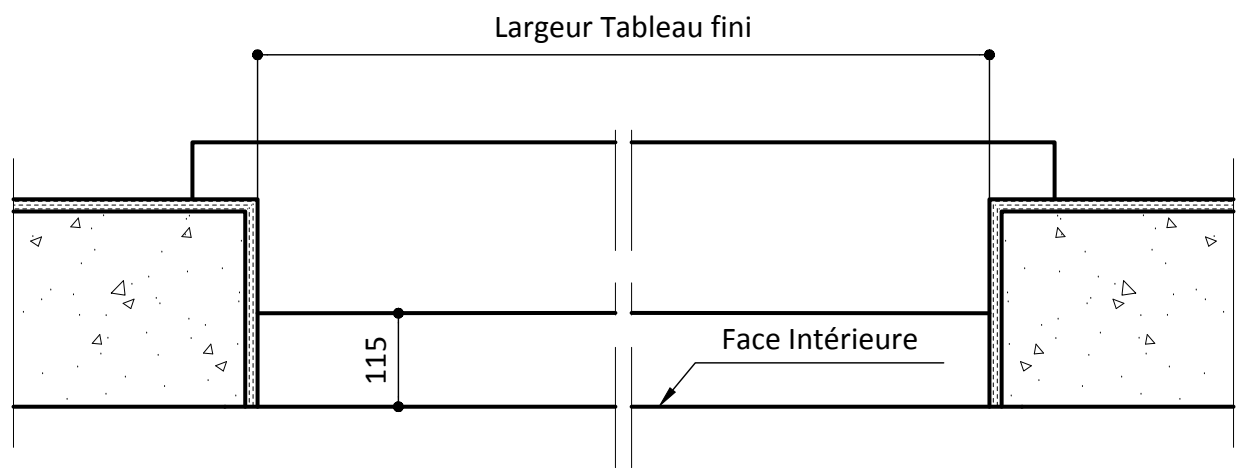

Désignation du plan :
 FRAPPE SUR ALLEGE - POSE TUNNEL
 SANS RECOUVREMENT-AVEC VR

Fichier : ResaCAIB_Pvc_P1.dwg

Des. : M.CHAUVIERE Ech : 1 / 10 B3

Date : 09/01/2018 N° : 12186

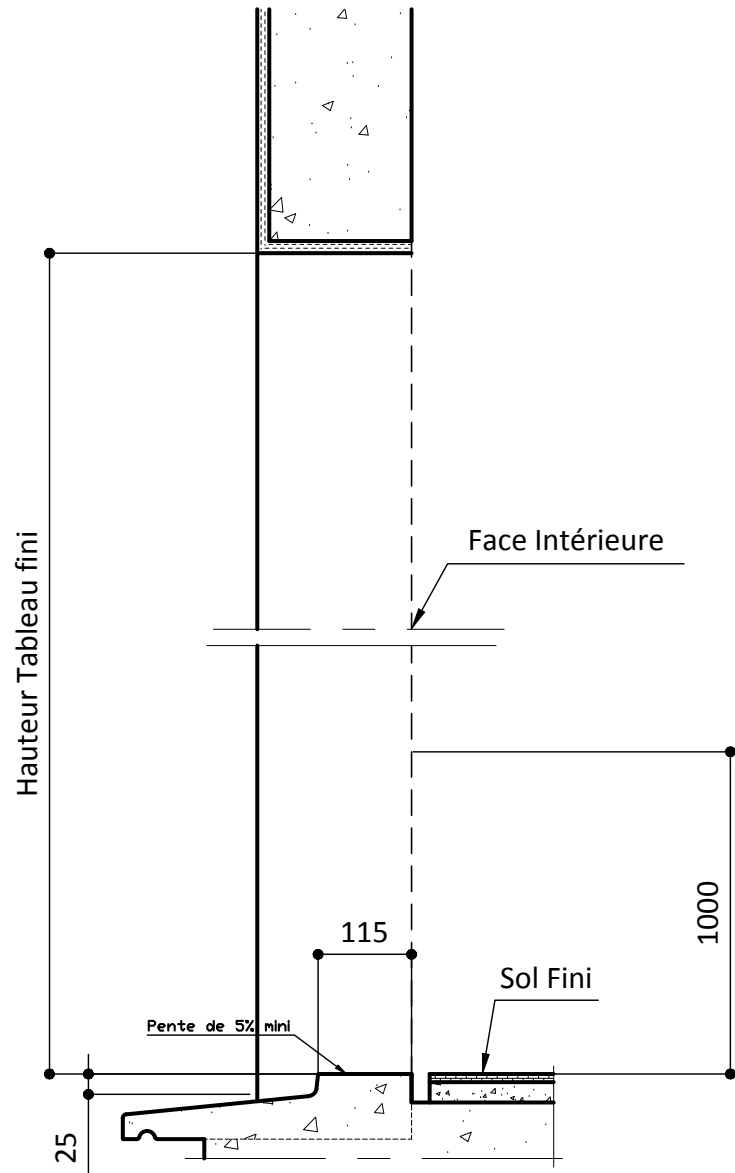

REPÈRE	TABLEAU FINI		SENS D'OUVERTURE	VITRAGE EXT / INT	OBSERVATIONS	QTE
	HAUTEUR	LARGEUR				

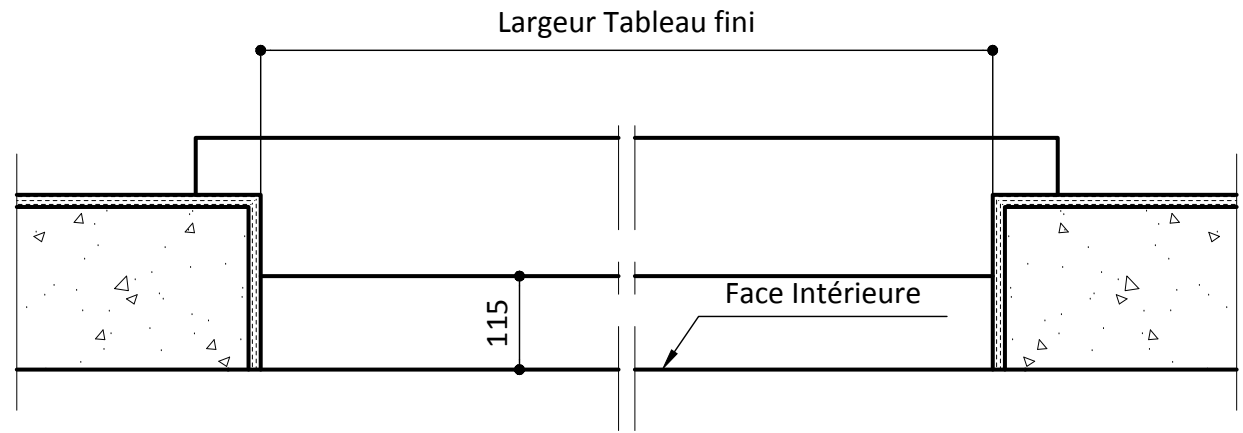

Désignation du plan :
 FRAPPE SUR SOL FINI-POSE TUNNEL
 SANS RECOUVREMENT-SANS VR

Fichier : ResaCAIB_Pvc_P1.dwg

Des. : M.CHAUVIERE Ech : 1 / 10 D3

Date : 09/01/2018 N° : 12196

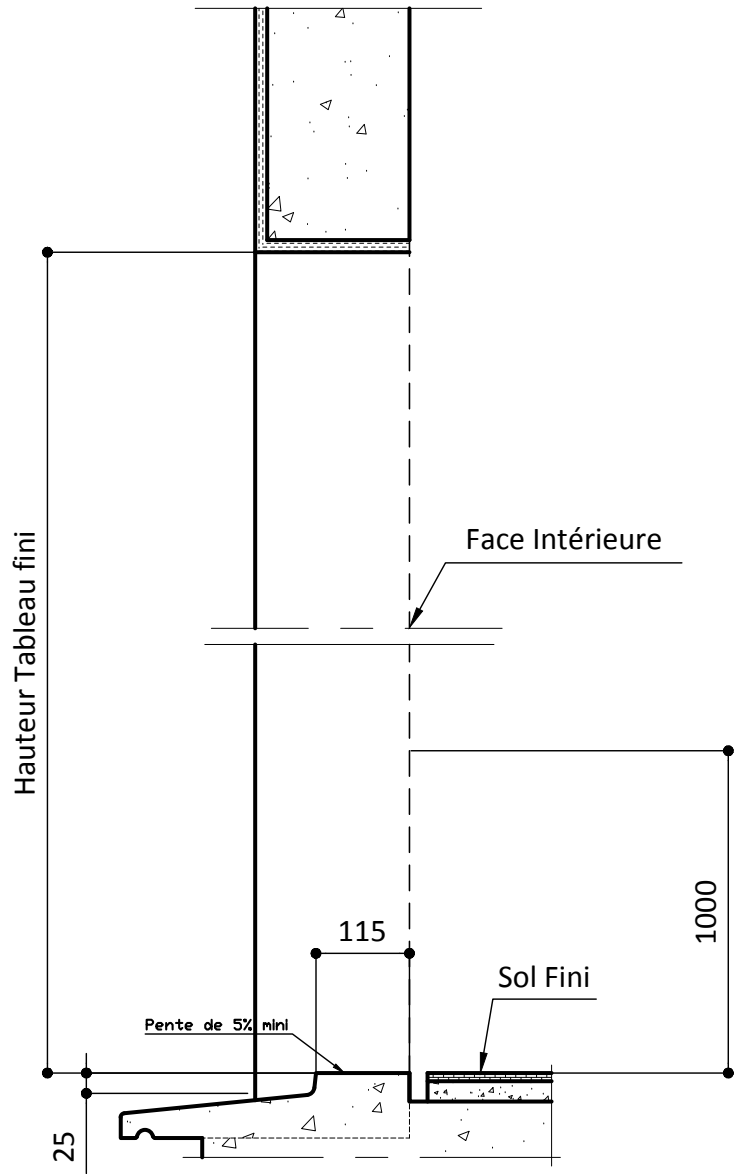

REPÈRE	TABLEAU FINI		SENS D'OUVERTURE	VITRAGE EXT / INT	OBSERVATIONS	QTE
	HAUTEUR	LARGEUR				

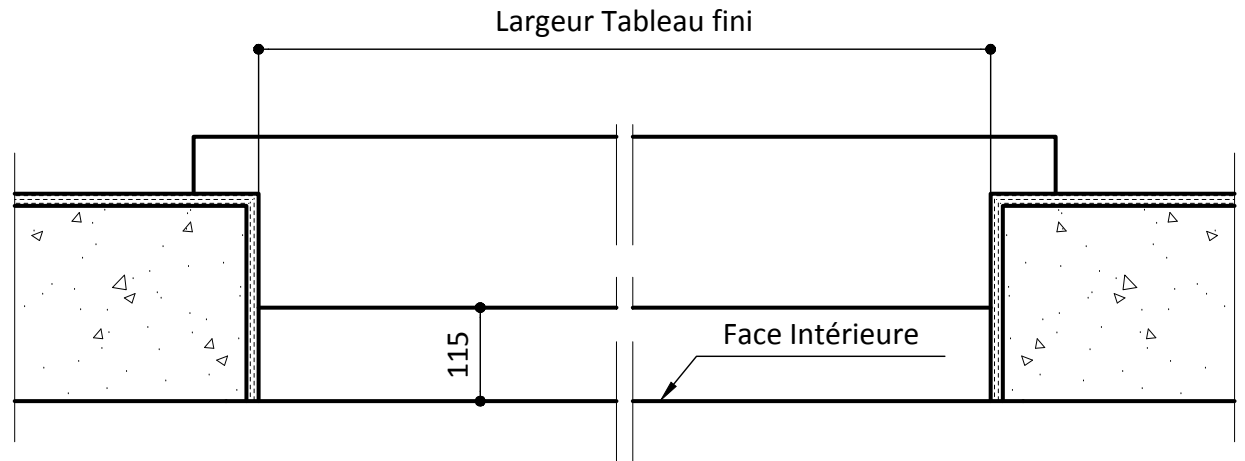

Désignation du plan :
 FRAPPE SOL FINI - POSE TUNNEL
 SANS RECOUVREMENT-AVEC VR

Fichier : ResaCAIB_Pvc_P1.dwg

Des. : M.CHAUVIERE Ech : 1 / 10 E3

Date : 09/01/2018 N° : 12201

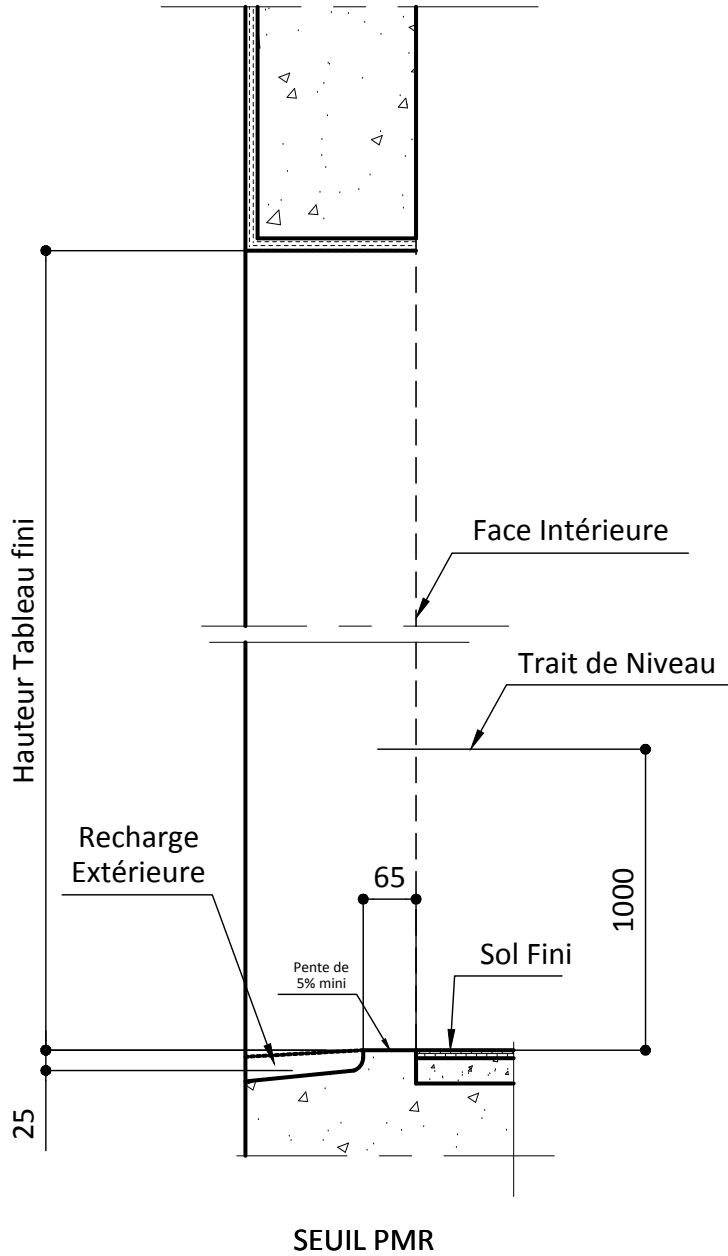

REPÈRE	TABLEAU FINI		SENS D'OUVERTURE	VITRAGE EXT / INT	OBSERVATIONS	QTE
	HAUTEUR	LARGEUR				

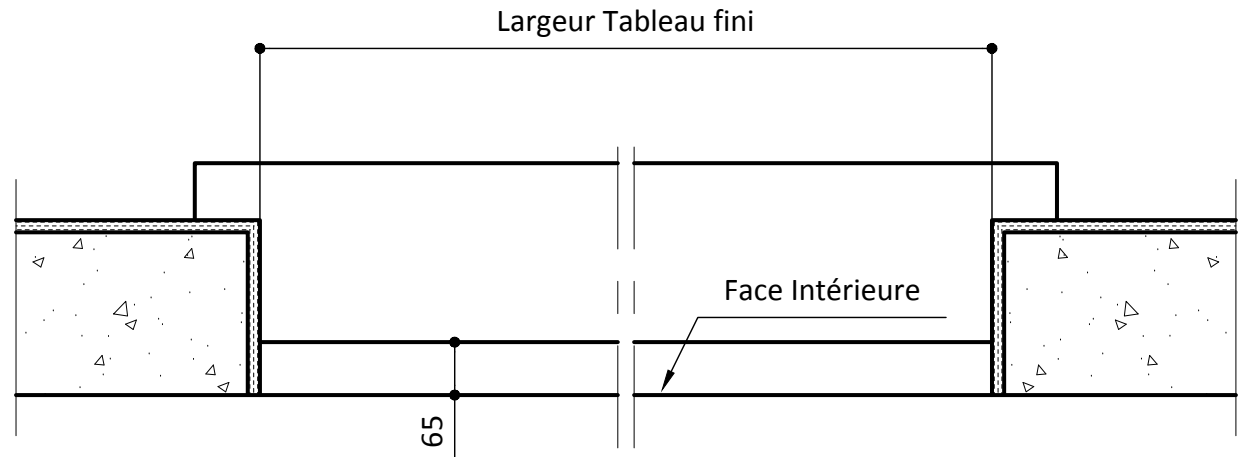

Désignation du plan :
 FRAPPE SEUIL PMR - POSE TUNNEL
 SANS RECOUVREMENT-SANS VR

Fichier : ResaCAIB_Pvc_P1.dwg

Des. : M.CHAUVIERE Ech : 1 / 10 J3

Date : 09/01/2018 N° : 12226

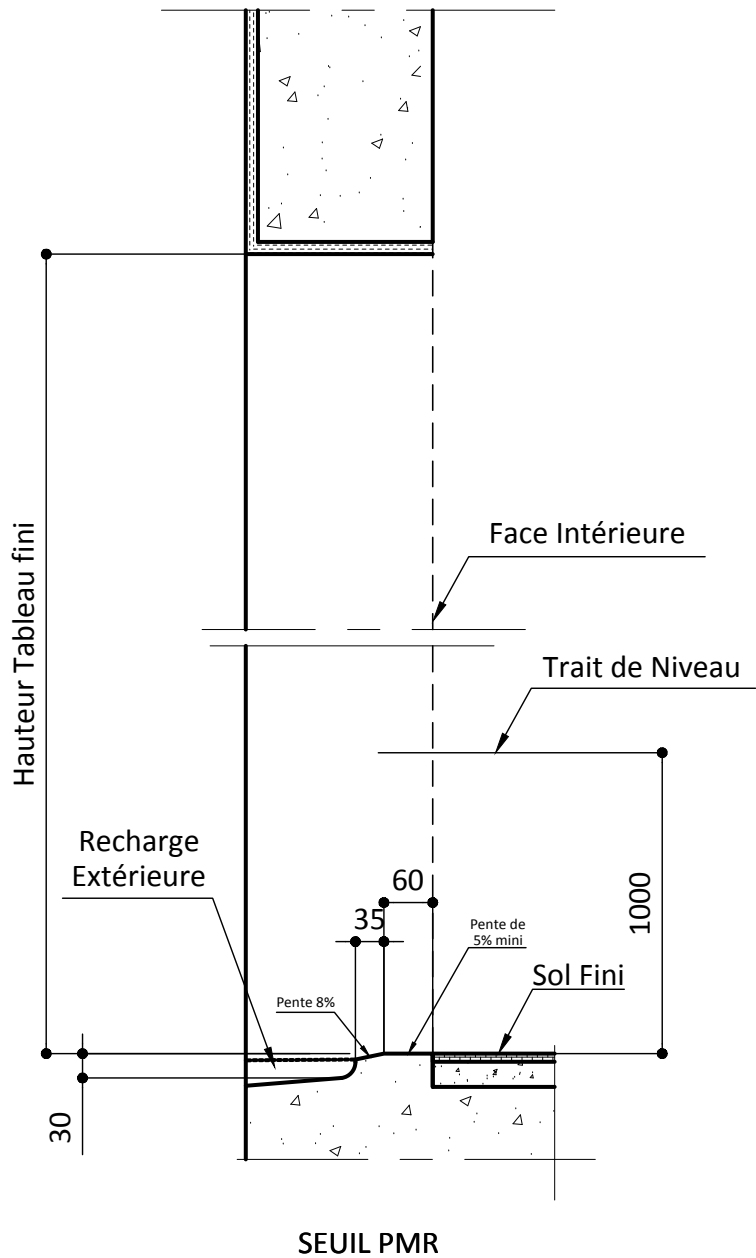

REPÈRE	TABLEAU FINI		SENS D'OUVERTURE	VITRAGE EXT / INT	OBSERVATIONS	QTE
	HAUTEUR	LARGEUR				

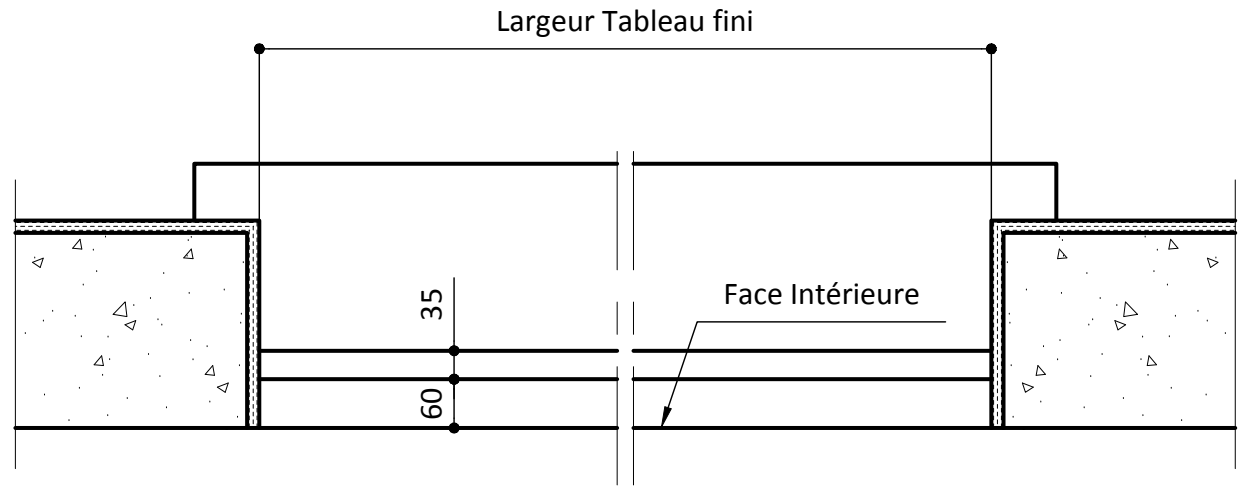

Désignation du plan :
FRAPPE SEUIL PMR - POSE TUNNEL
SANS RECOUVREMENT-AVEC VR

Fichier : ResaCAIB_Pvc_P1.dwg
Des. : M.CHAUVIERE Ech : 1 / 10 K3
Date : 09/01/2018 N° : 12231

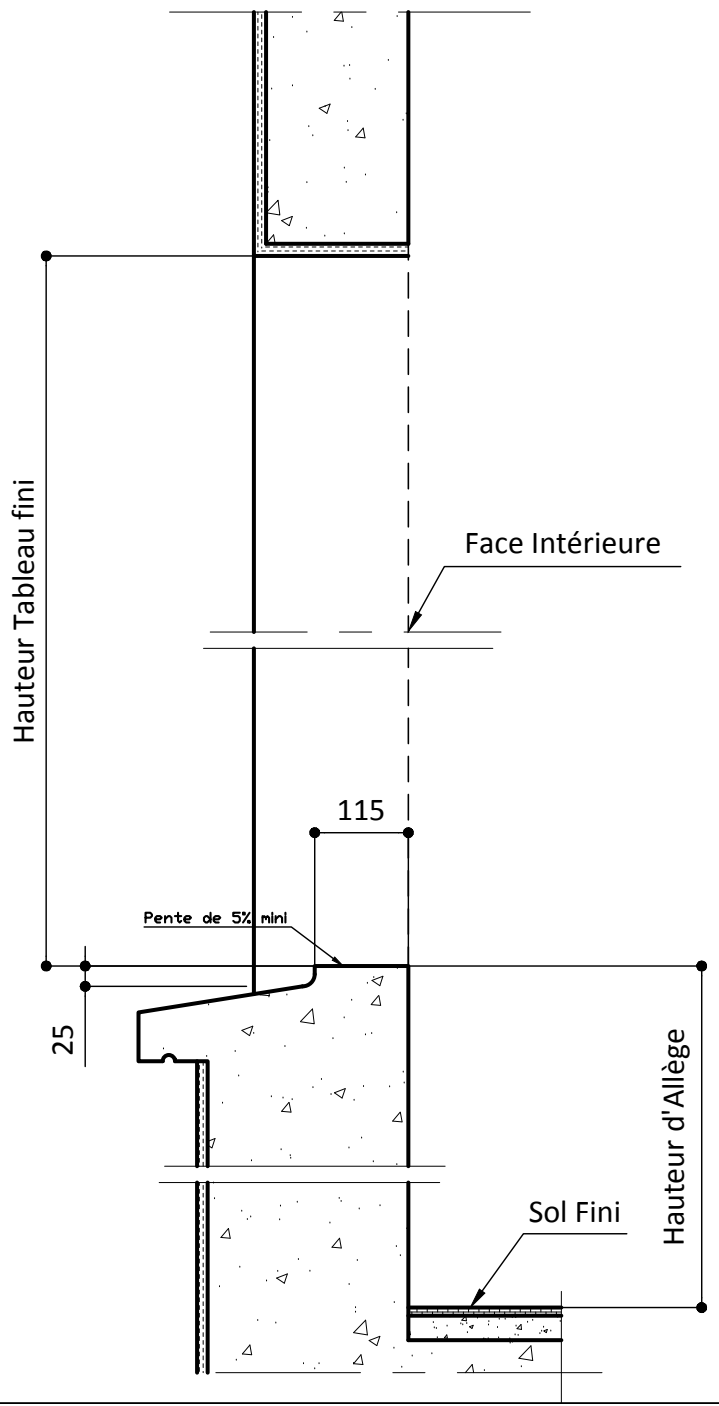

REPÈRE	TABLEAU FINI		SENS D'OUVERTURE	VITRAGE EXT / INT	OBSERVATIONS	QTE
	HAUTEUR	LARGEUR				

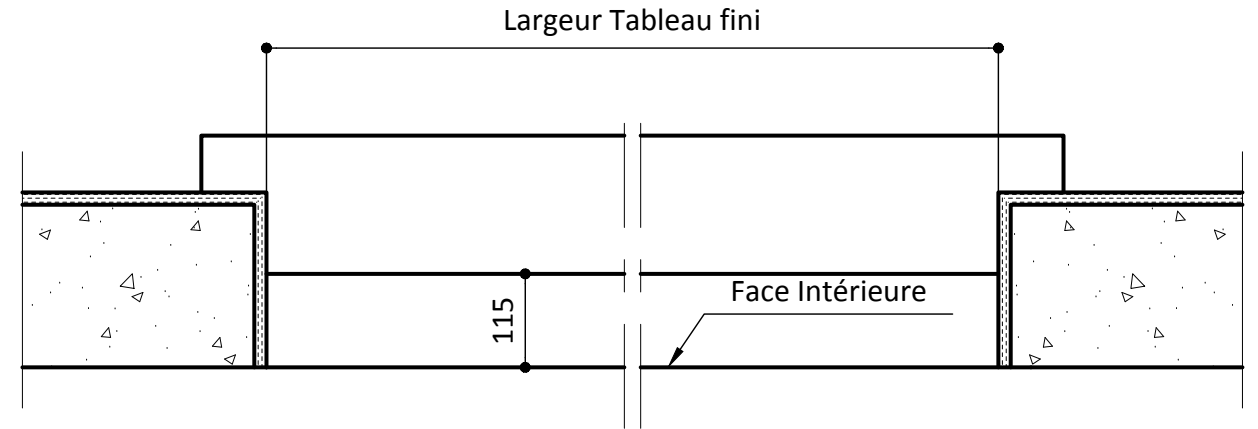

Désignation du plan :
 FRAPPE SUR ALLEGE - POSE TUNNEL
 SANS RECOUVREMENT-SANS VR

Fichier : ResaCAIB_Pvc_P1.dwg

Des. : M.CHAUVIERE Ech : 1 / 10 M3

Date : 09/01/2018 N° : 12241

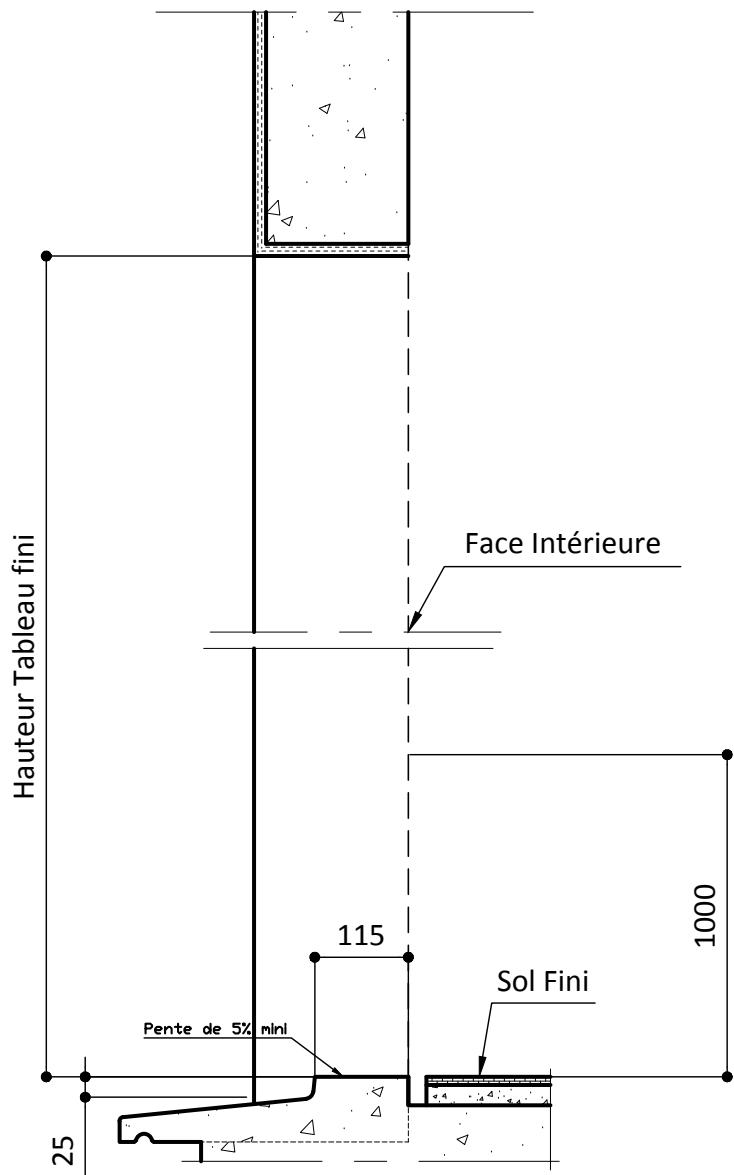

REPÈRE	TABLEAU FINI		SENS D'OUVERTURE	VITRAGE EXT / INT	OBSERVATIONS	QTE
	HAUTEUR	LARGEUR				

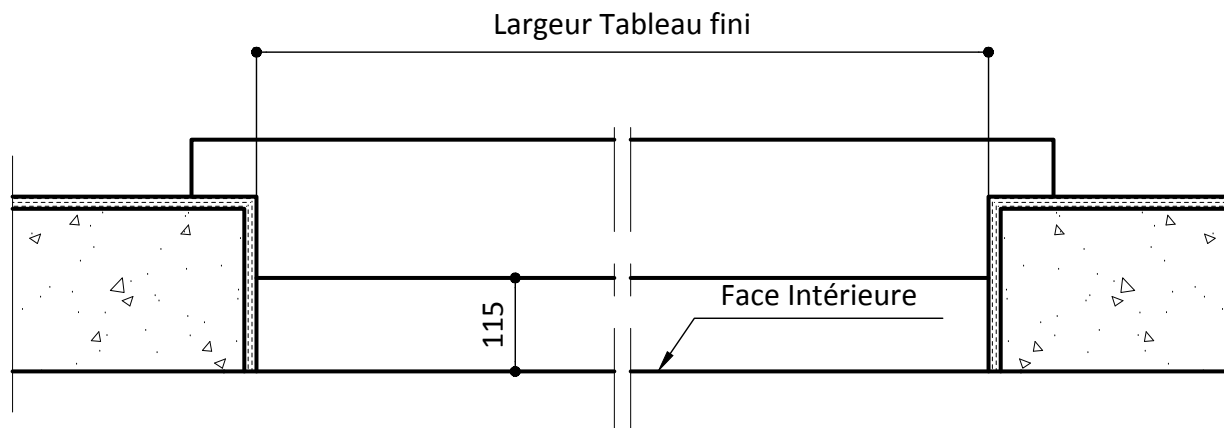

Désignation du plan :
FRAPPE SUR SOL FINI - POSE FEUILLURE
SANS RECOUVREMENT-SANS VR

Fichier : ResaCAIB_Pvc_P1.dwg
Des. : M.CHAUVIERE Ech : 1 / 10 P3
Date : 09/01/2018 N° : 12256

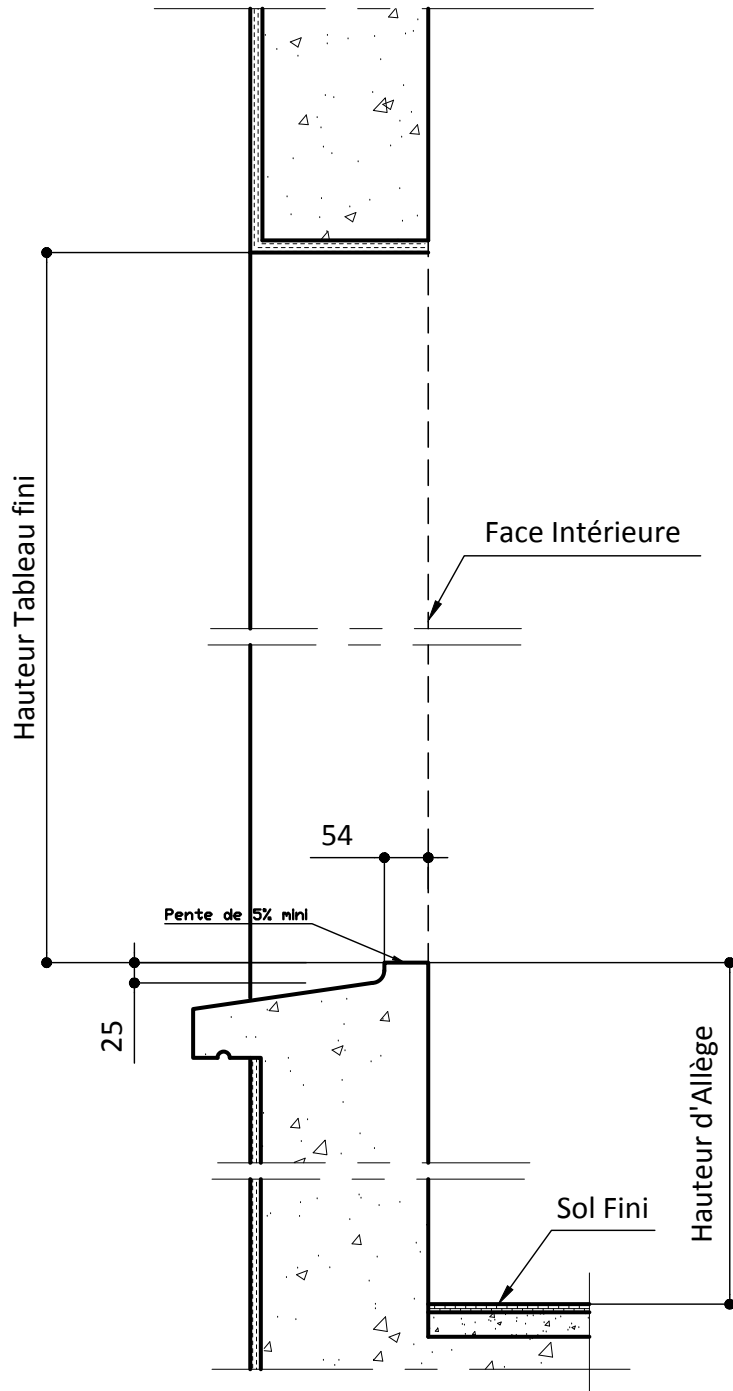

REPÈRE	TABLEAU FINI		SENS D'OUVERTURE	VITRAGE EXT / INT	OBSERVATIONS	QTE
	HAUTEUR	LARGEUR				

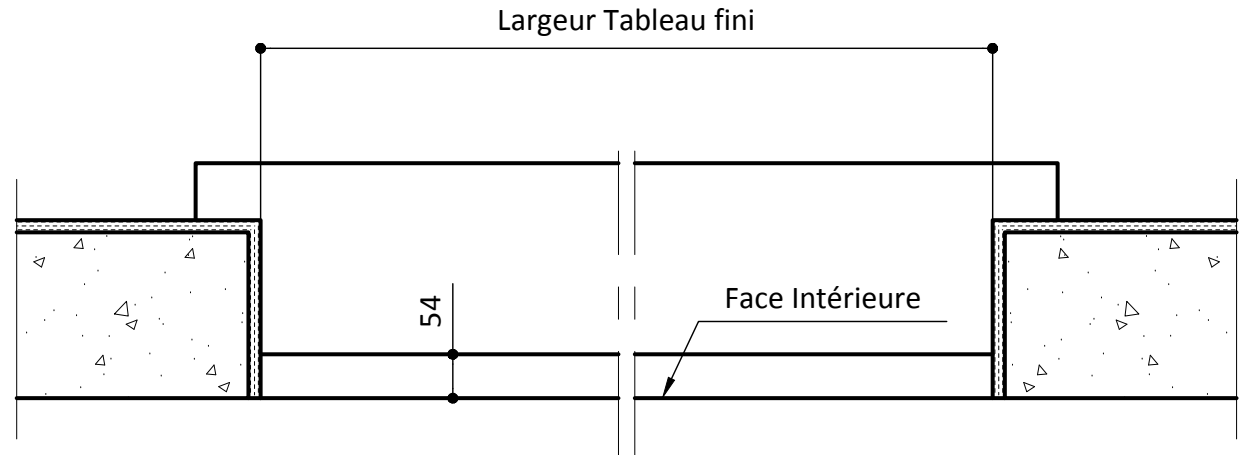

Désignation du plan :
FRAPPE SUR ALLEGE - POSE TUNNEL
AVEC RECOUVREMENT-SANS VR

Fichier : ResaCAIB_Pvc_P1.dwg
Des. : M.CHAUVIERE Ech : 1 / 10 A4
Date : 09/01/2018 N° : 12271

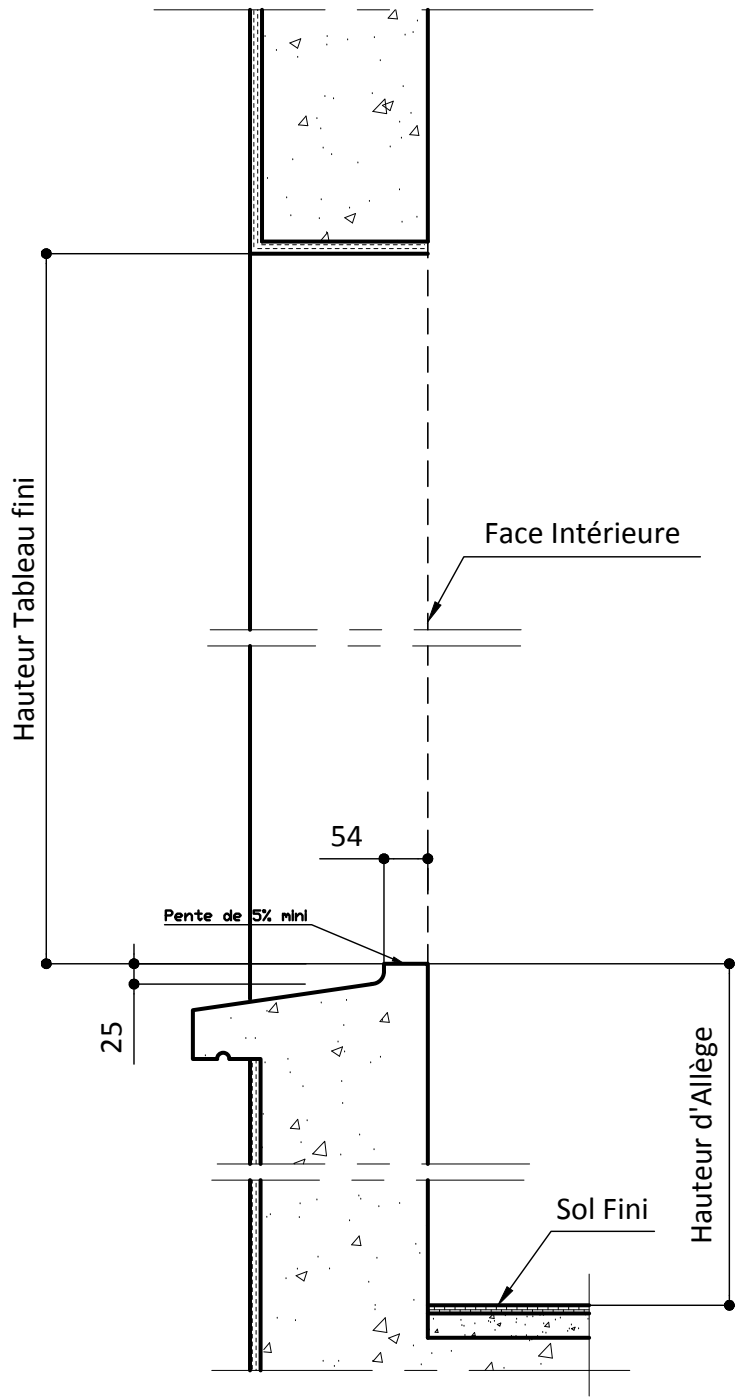

REPÈRE	TABLEAU FINI		SENS D'OUVERTURE	VITRAGE EXT / INT	OBSERVATIONS	QTE
	HAUTEUR	LARGEUR				

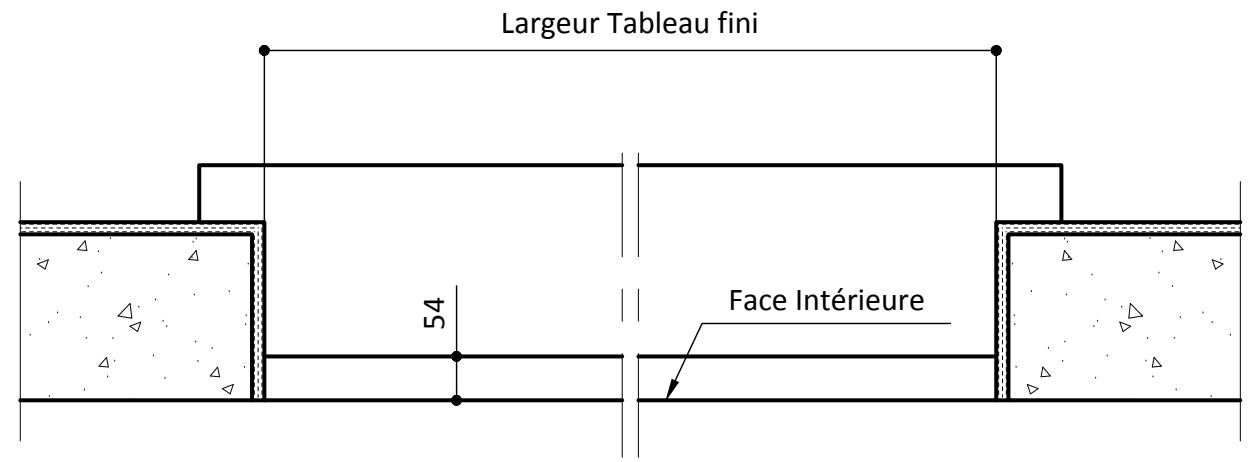

Désignation du plan :
 FRAPPE SUR ALLEGE - POSE TUNNEL
 AVEC RECOUVREMENT-AVEC VR

Fichier : ResaCAIB_Pvc_P1.dwg

Des. : M.CHAUVIERE Ech : 1 / 10 B4

Date : 09/01/2018 N° : 12276

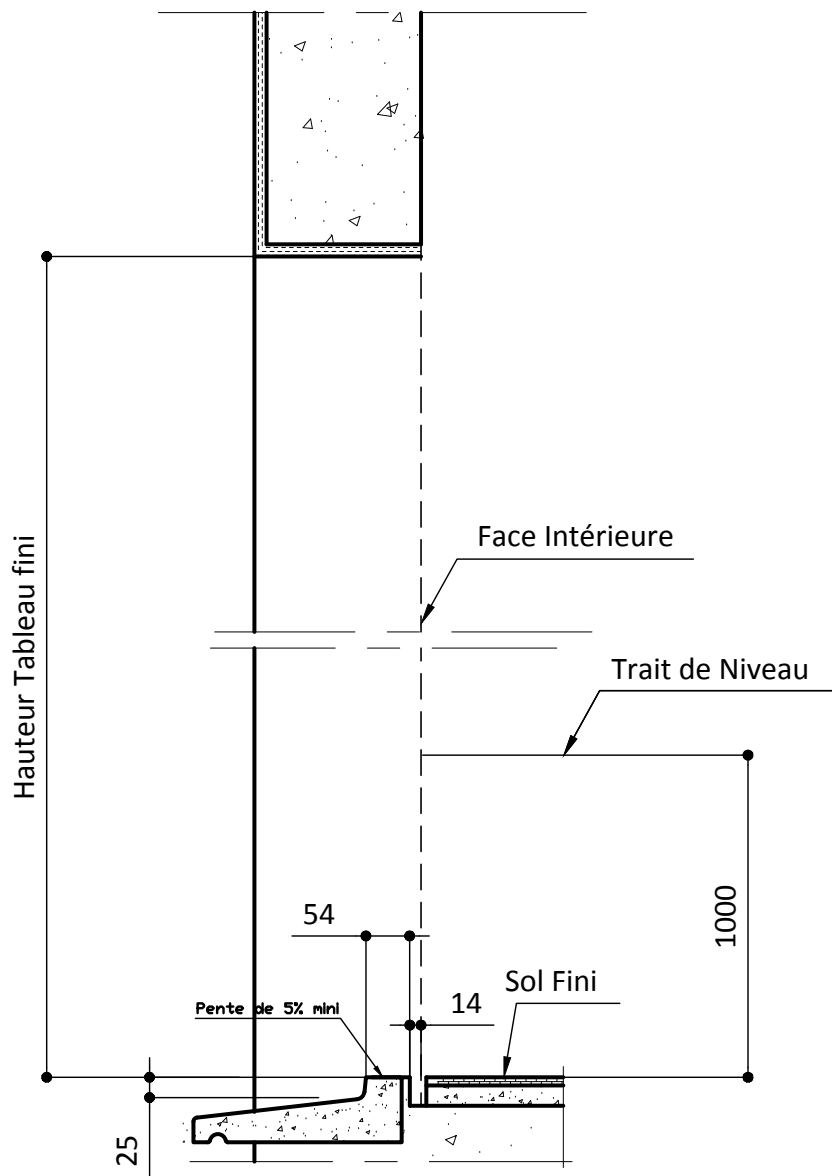

SEUIL STANDARD

REPÈRE	TABLEAU FINI		SENS D'OUVERTURE	VITRAGE EXT / INT	OBSERVATIONS	QTE
	HAUTEUR	LARGEUR				

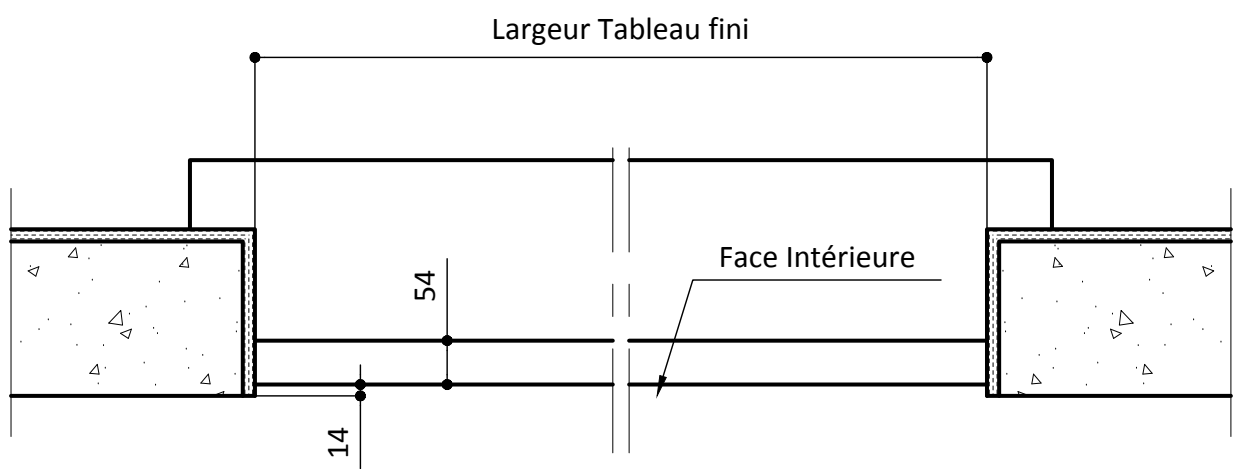

Désignation du plan :
 FRAPPE SUR SOL FINI-POSE TUNNEL
 AVEC RECOUVREMENT-SANS VR

Fichier : ResaCAIB_Pvc_P1.dwg

Des. : M.CHAUVIERE Ech : 1 / 10 D4

Date : 09/01/2018 N° : 12286

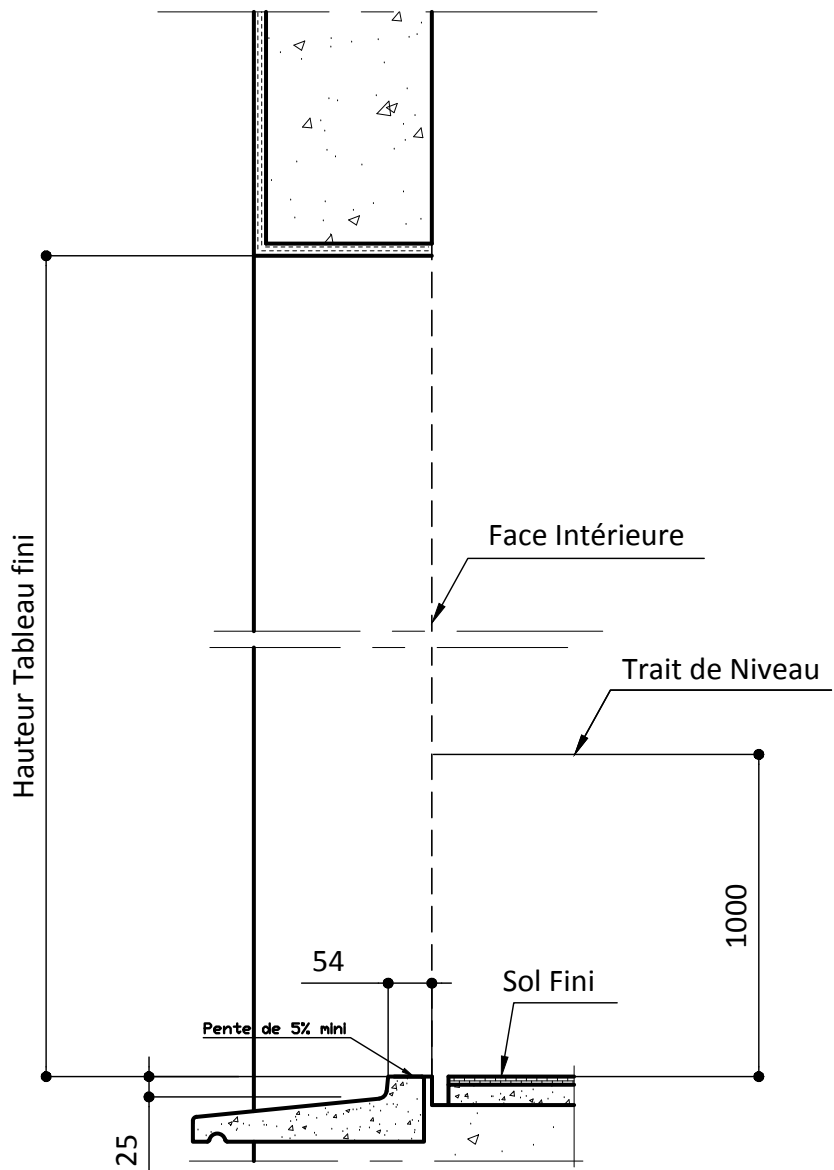

SEUIL STANDARD

REPÈRE	TABLEAU FINI		SENS D'OUVERTURE	VITRAGE EXT / INT	OBSERVATIONS	QTE
	HAUTEUR	LARGEUR				

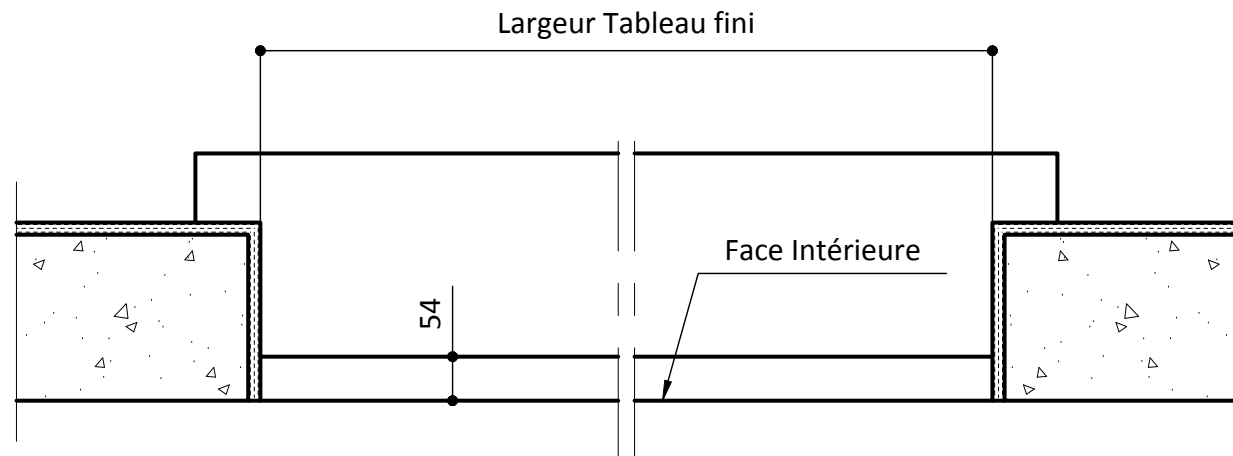

Désignation du plan :
FRAPPE SOL FINI - POSE TUNNEL
AVEC RECOUVREMENT-AVEC VR

Fichier : ResaCAIB_Pvc_P1.dwg

Des. : M.CHAUVIERE Ech : 1 / 10 E4

Date : 09/01/2018 N° : 12291

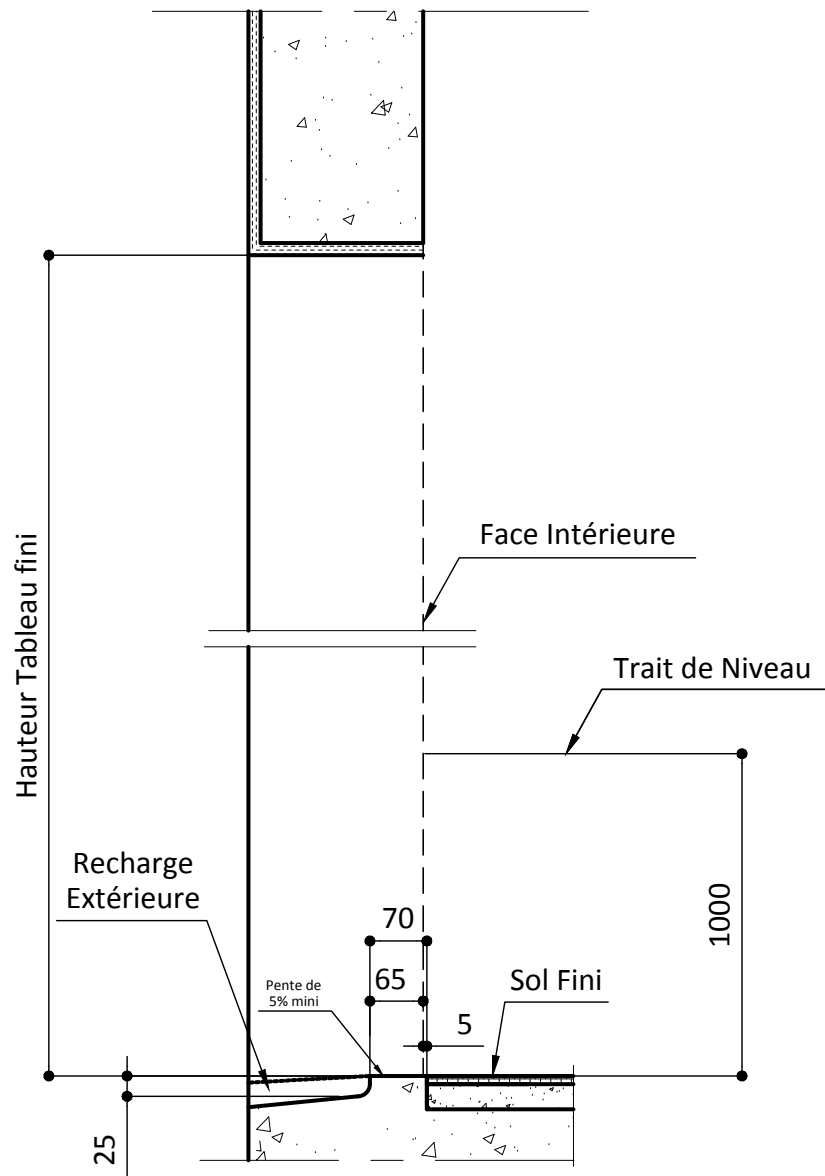

SEUIL PMR

REPÈRE	TABLEAU FINI		SENS D'OUVERTURE	VITRAGE EXT / INT	OBSERVATIONS	QTE
	HAUTEUR	LARGEUR				

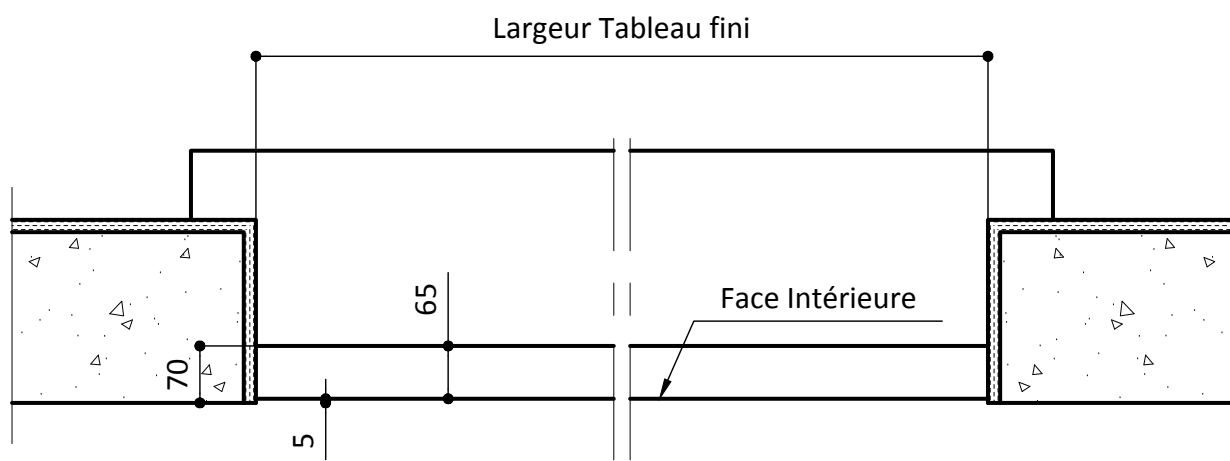

Désignation du plan :
 FRAPPE SEUIL PMR - POSE TUNNEL
 AVEC RECOUVREMENT-SANS VR

Fichier : ResaCAIB_Pvc_P1.dwg

Des. : M.CHAUVIERE Ech : 1 / 10 J4

Date : 09/01/2018 N° : 12316

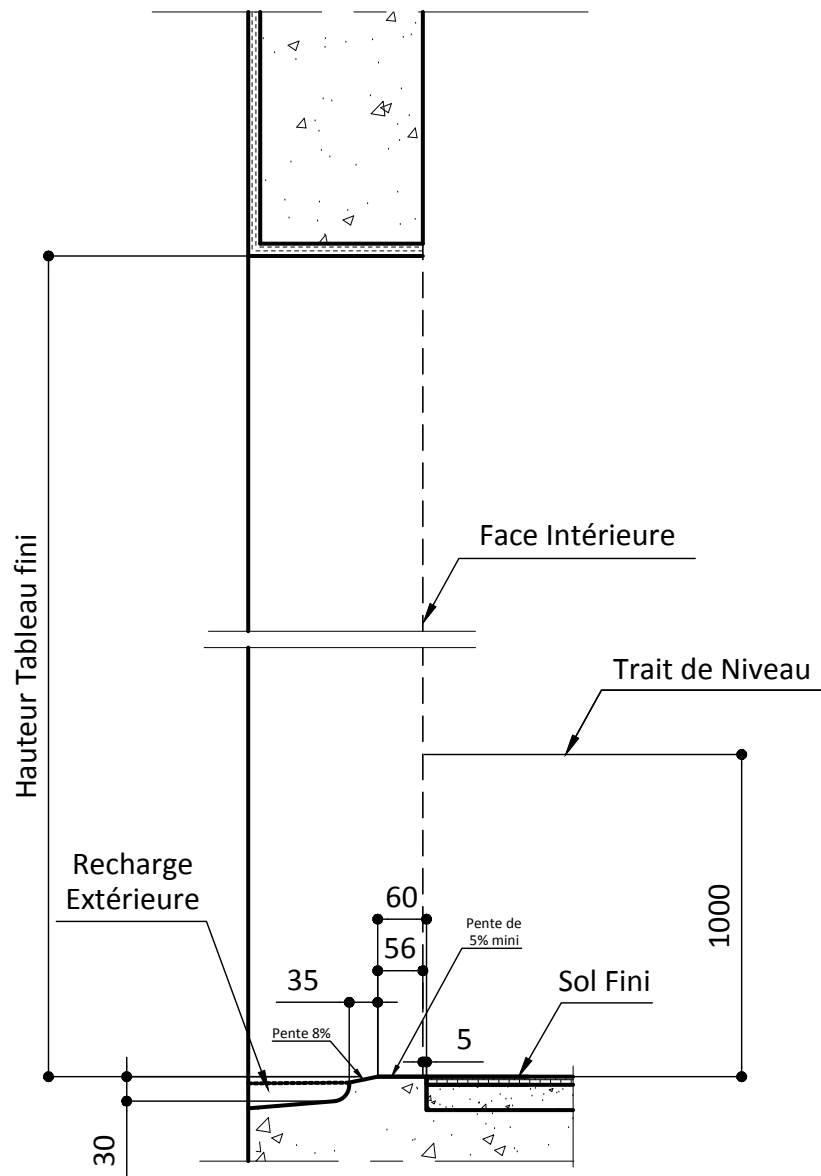

SEUIL PMR

REPÈRE	TABLEAU FINI		SENS D'OUVERTURE	VITRAGE EXT / INT	OBSERVATIONS	QTE
	HAUTEUR	LARGEUR				

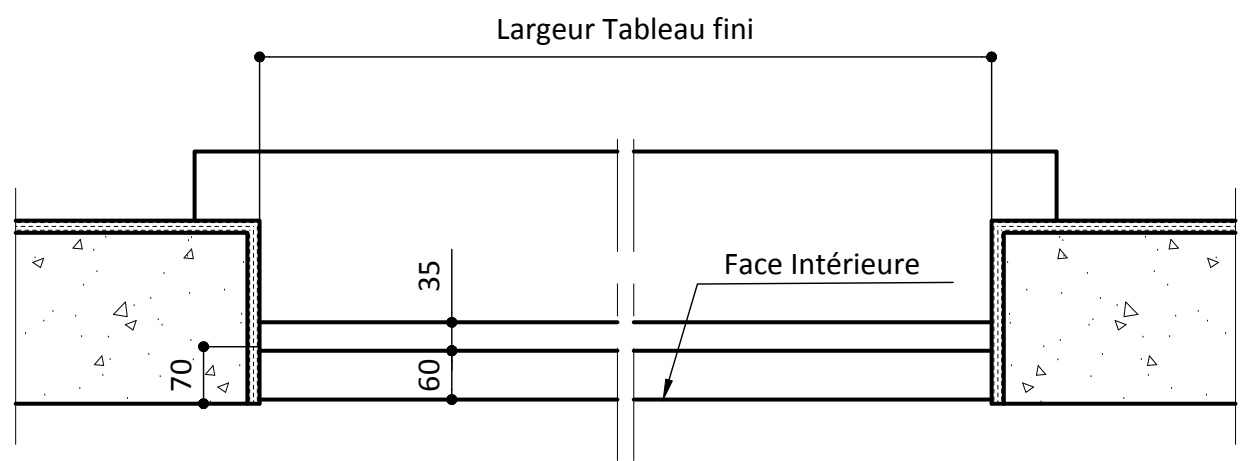

Désignation du plan :
 FRAPPE SEUIL PMR - POSE TUNNEL
 AVEC RECOUVREMENT-AVEC VR

Fichier : ResaCAIB_Pvc_P1.dwg

Des. : M.CHAUVIERE Ech : 1 / 10 K4

Date : 09/01/2018 N° : 12321