

ALU

# PORTE-FENÊTRE A GALANDAGE 1F+ 4 RAILS 1 CÔTÉ 4 VANTAUX

## DORMANT 290 mm SEUIL ENCASTRÉ PARTIEL

COUPE VERTICALE

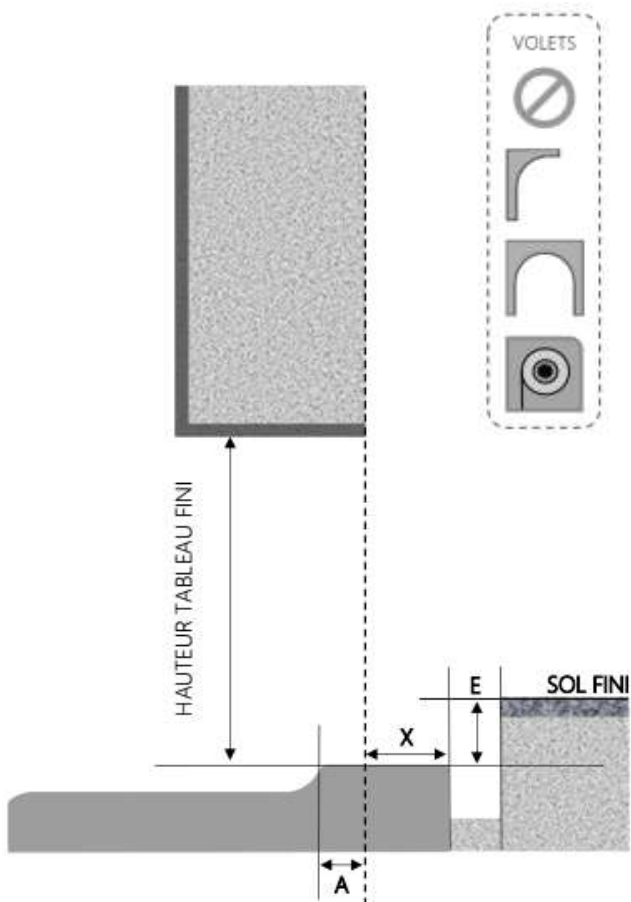

REPERE	TYOLOGIE	ALLEGE	HAUTEUR	LARGEUR

COUPE HORIZONTALE

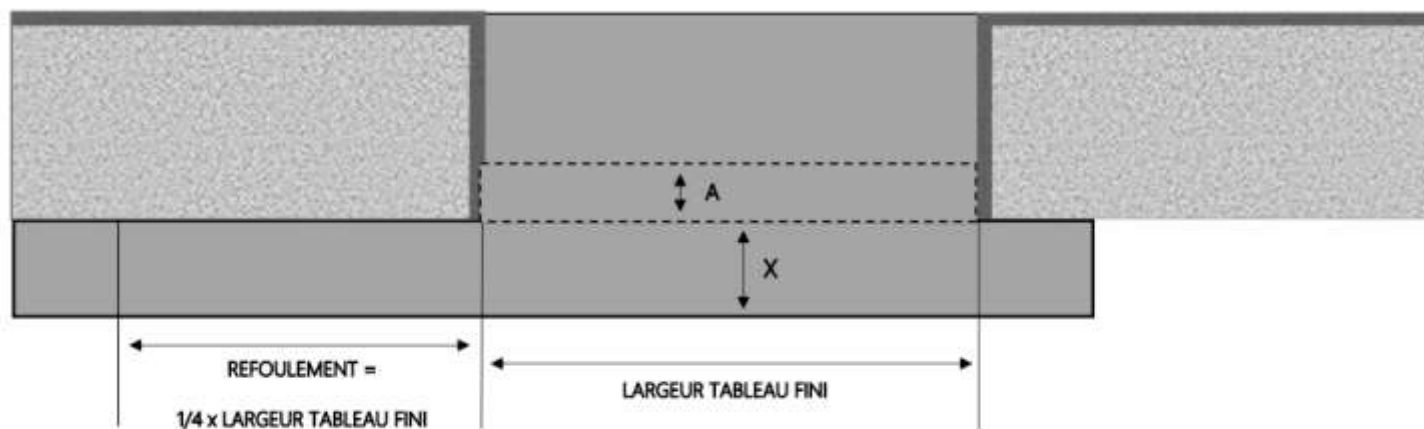

X = SEUIL	180 mm
A = AVANCÉE	13 mm
E = ENCASTREMENT	35 mm

1.3.3.A.4R1C.1F+.290.ENCAPART



MENUISERIES POUR BÂTISSEURS

ALU

# PORTE-FENÊTRE A GALANDAGE 1F+ 4 RAILS 1 CÔTÉ 4 VANTAUX

## DORMANT 290 mm SEUIL ENCASTRÉ TOTAL

COUPE VERTICALE

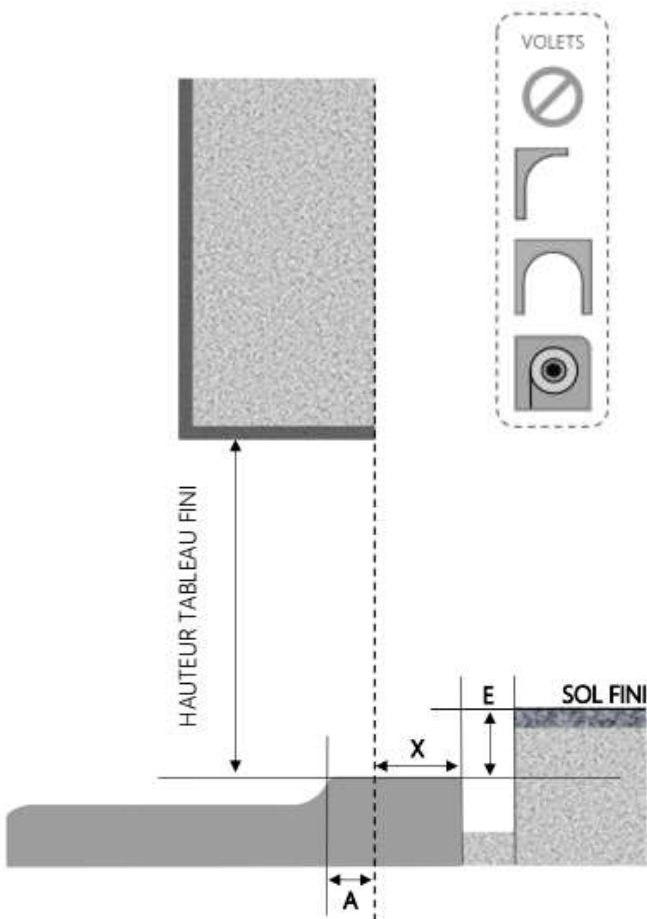

REPÈRE	TPOLOGIE	ALÈGE	HAUTEUR	LARGEUR

COUPE HORIZONTALE

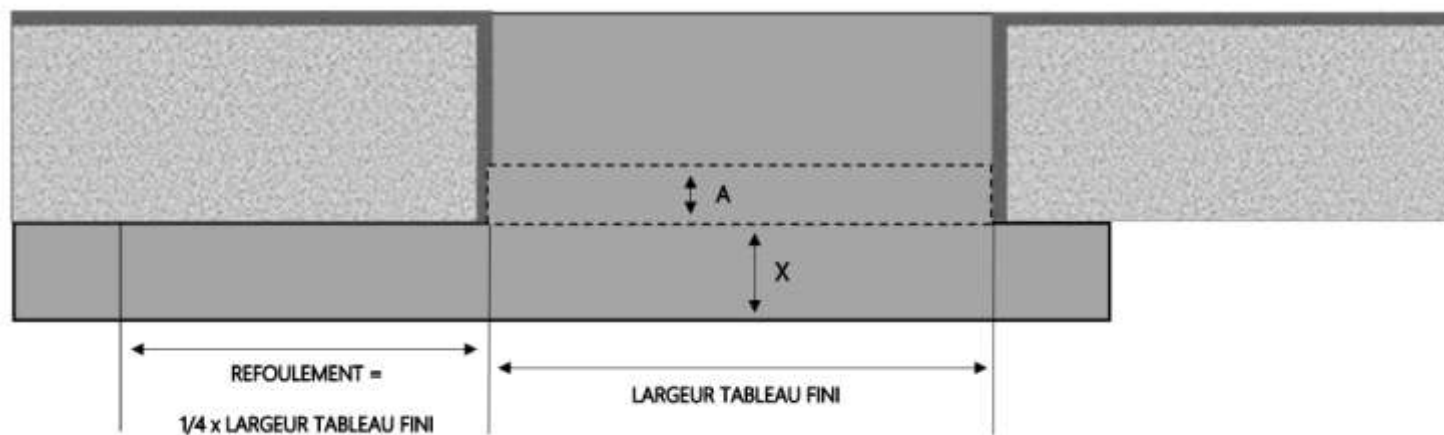

X = SEUIL	180 mm
A = AVANCÉE	13 mm
E = ENCASTREMENT	45 mm

1.3.3.A.4R1C.1F+ .290.ENCATOT



MENUISERIES POUR BÂTISSEURS

ALU

# FENÊTRE A GALANDAGE 1F+ 4 RAILS 1 CÔTÉ 4 VANTAUX

## DORMANT 290 mm SUR APPUI SEUIL STANDARD

COUPE VERTICALE

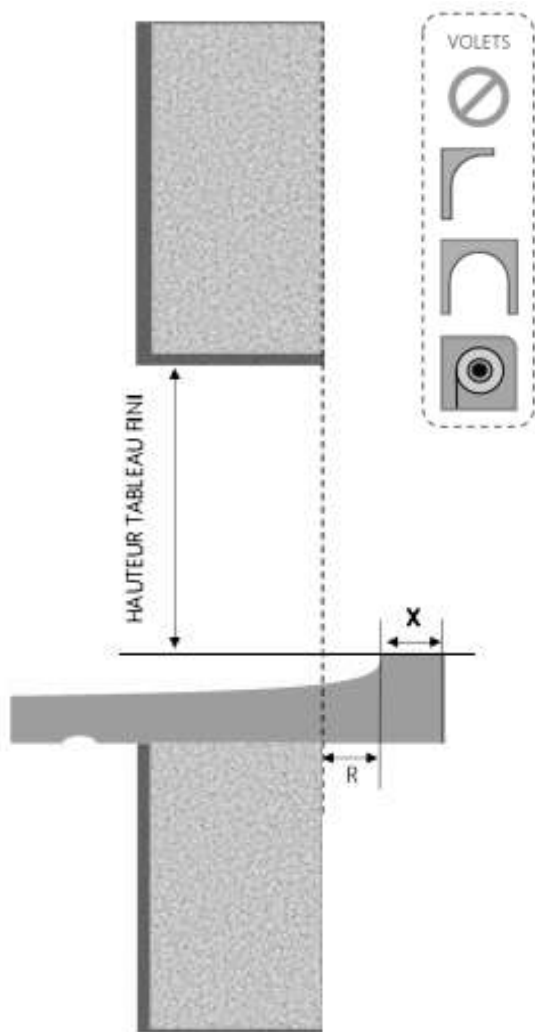

REPÈRE	TPOLOGIE	ALLEGE	HAUTEUR	LARGEUR

COUPE HORIZONTALE

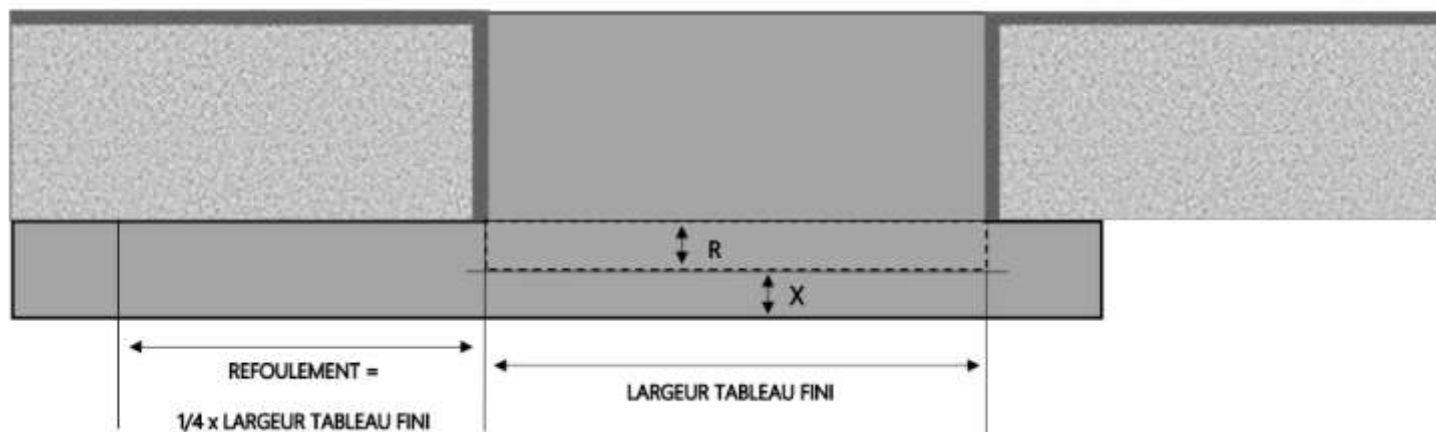

X = SEUIL	40 mm
R = RECUL	50 mm

1.3.3.A.4R1C.1F+.290.SA.STD



MENUISERIES POUR BÂTISSEURS

ALU

# PORTE-FENÊTRE A GALANDAGE 1F+ 4 RAILS 1 CÔTÉ 4 VANTAUX

## DORMANT 290 mm SEUIL STANDARD

COUPE VERTICALE

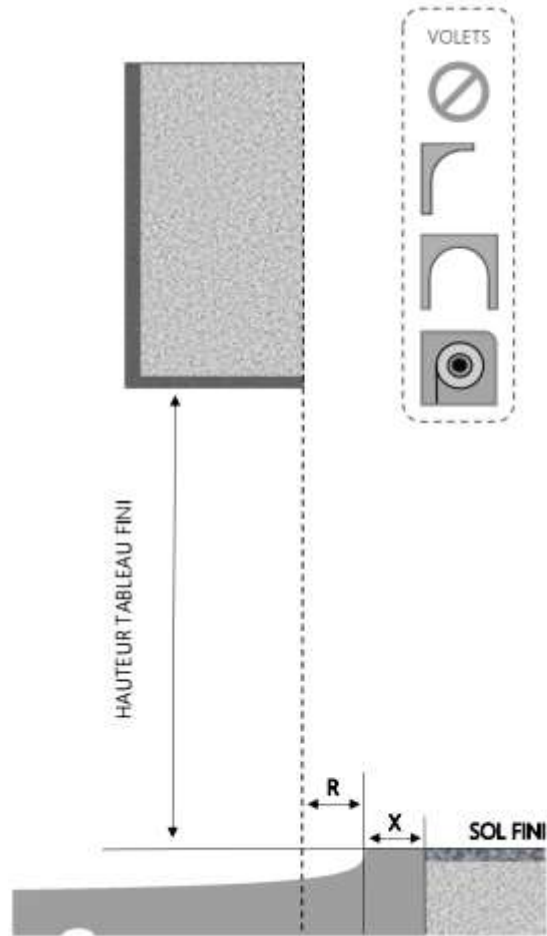

REPÈRE	TPOLOGIE	ALLEGE	HAUTEUR	LARGEUR

COUPE HORIZONTALE

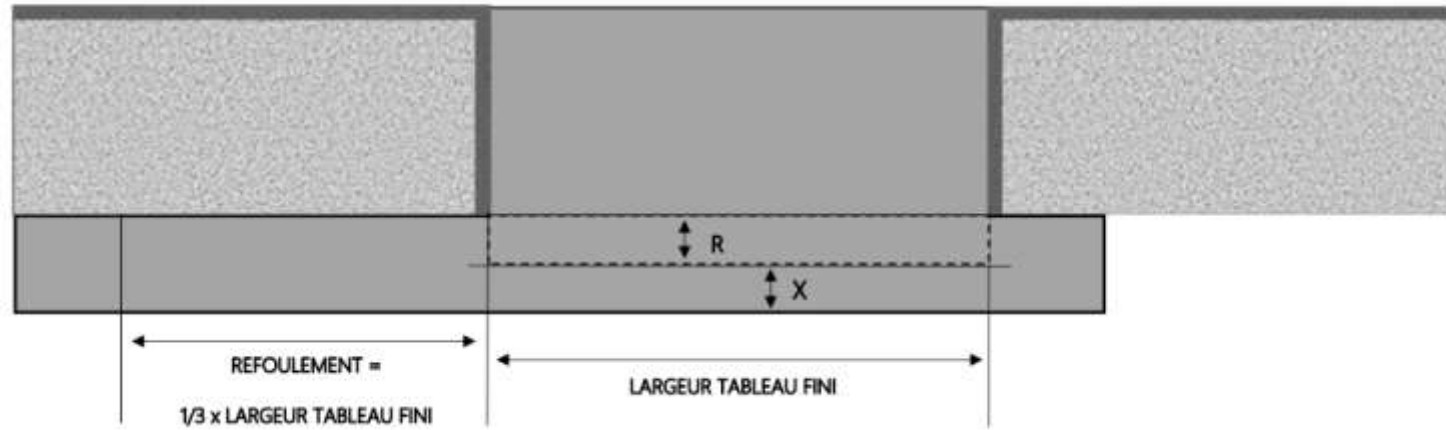

X = SEUIL	191 mm
R = RECUL	50 mm

1.3.3.A.4R1C.1F+.290.STD



MENUISERIES POUR BÂTISSEURS

ALU

PORTE-FENÊTRE A GALANDAGE 1F+ 4 RAILS 2 CÔTÉS 8 VANTAUX

DORMANT 290 mm SEUIL ENCASTRÉ PARTIEL

COUPE VERTICALE

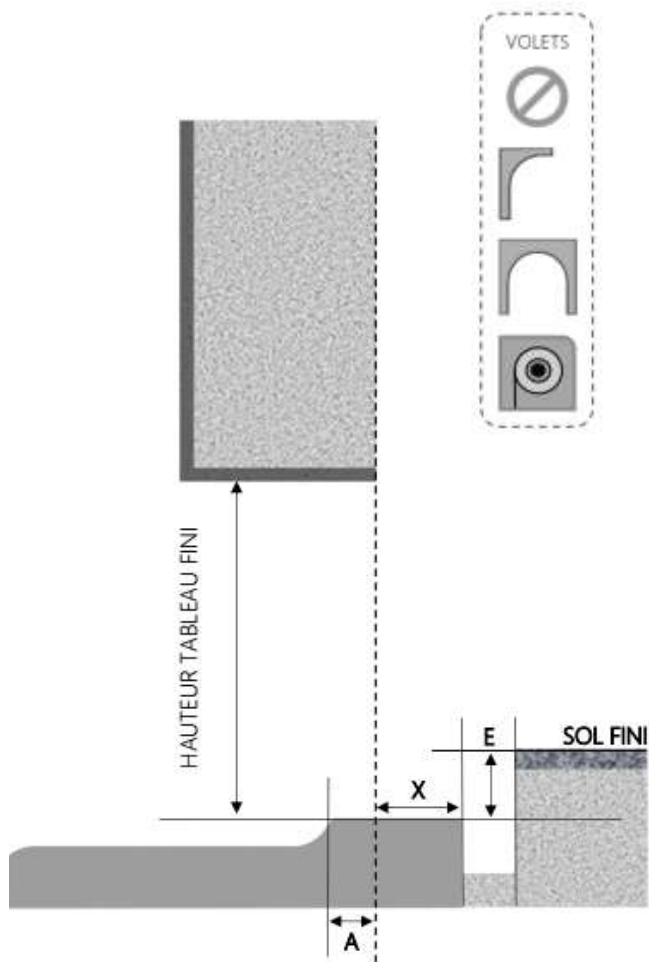

REPERE	TYOLOGIE	ALLEGE	HAUTEUR	LARGEUR

COUPE HORIZONTALE

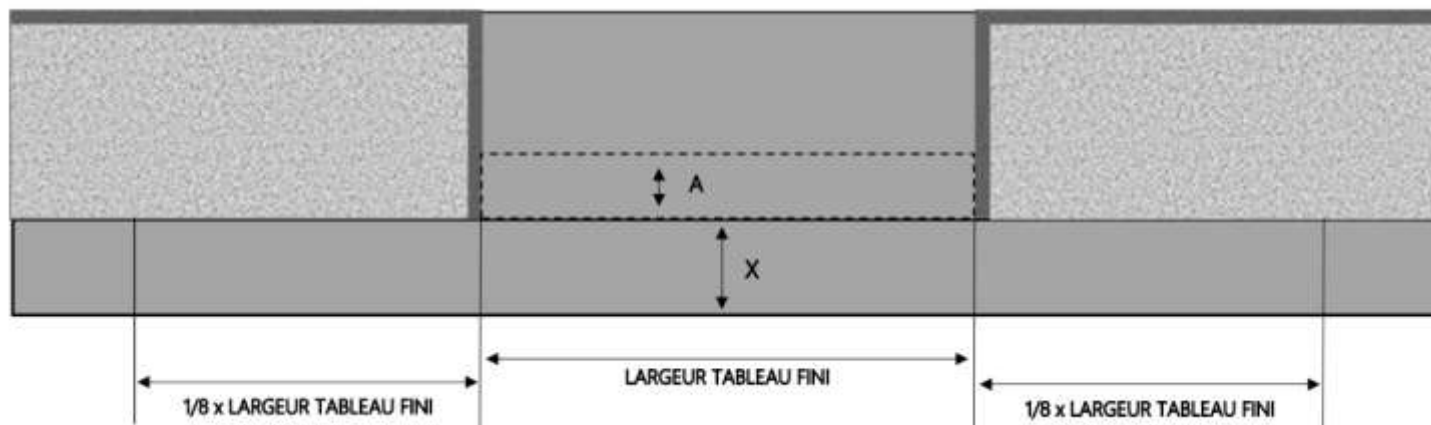

X = SEUIL	180 mm
A = AVANCÉE	13 mm
E = ENCASTREMENT	35 mm

1.3.3.A.4R2C.1F+.290.ENCAPART



MENUISERIES POUR BÂTISSEURS

ALU

# PORTE-FENÊTRE A GALANDAGE 1F+ 4 RAILS 2 CÔTÉS 8 VANTAUX

## DORMANT 290 mm SEUIL ENCASTRÉ TOTAL

COUPE VERTICALE

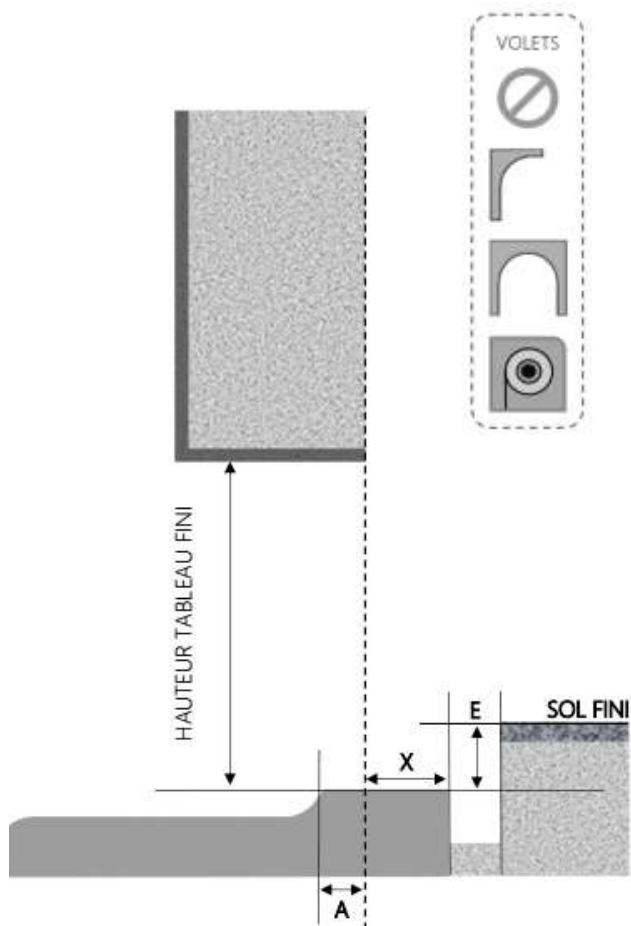

REPÈRE	TPOLOGIE	ALLEGE	HAUTEUR	LARGEUR

COUPE HORIZONTALE

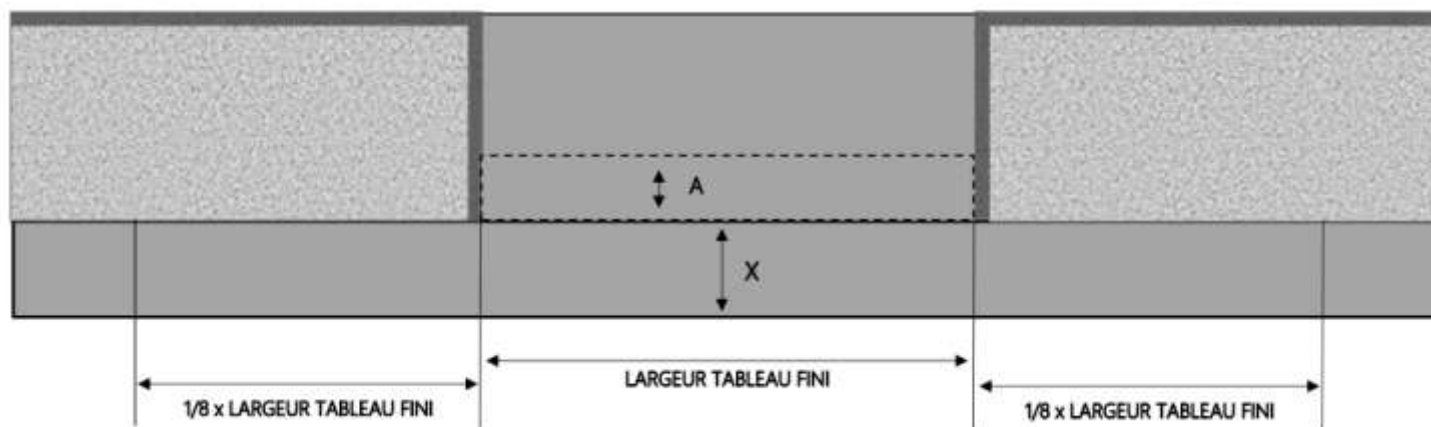

X = SEUIL	180 mm
A = AVANCÉE	13 mm
E = ENCASTREMENT	45 mm



MENUISERIES POUR BÂTISSEURS

1.3.3.A.4R2C.1F+.290.ENCATOT

ALU

# FENÊTRE A GALANDAGE 1F+ 4 RAILS 2 CÔTÉS 8 VANTAUX

## DORMANT 290 mm SUR APPUI SEUIL STANDARD

COUPE VERTICALE

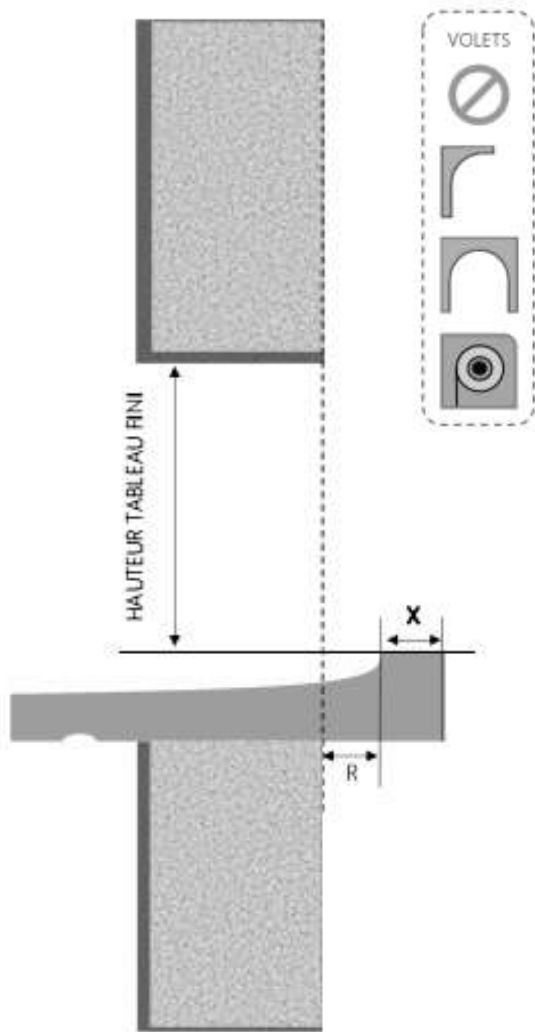

REPÈRE	TYPOLOGIE	ALÈGE	HAUTEUR	LARGEUR

COUPE HORIZONTALE

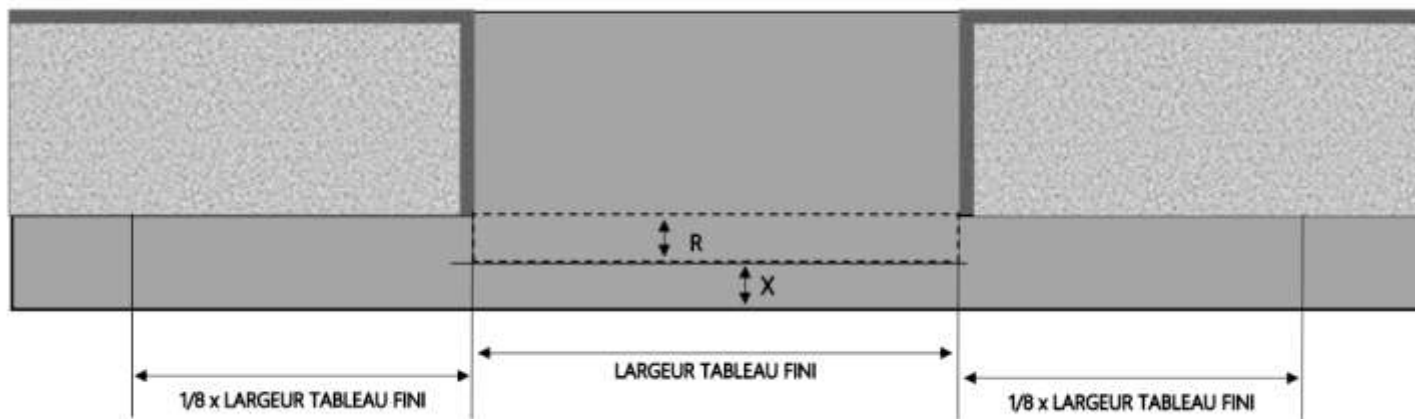

X = SEUIL	40 mm
R = RECUL	50 mm

1.3.3.A.4P2C.1F+.290.SA.STD



MENUISERIES POUR BÂTISSEURS

ALU

# PORTE-FENÊTRE A GALANDAGE 1F+ 4 RAILS 2 CÔTÉS 8 VANTAUX

## DORMANT 290 mm SEUIL STANDARD

COUPE VERTICALE

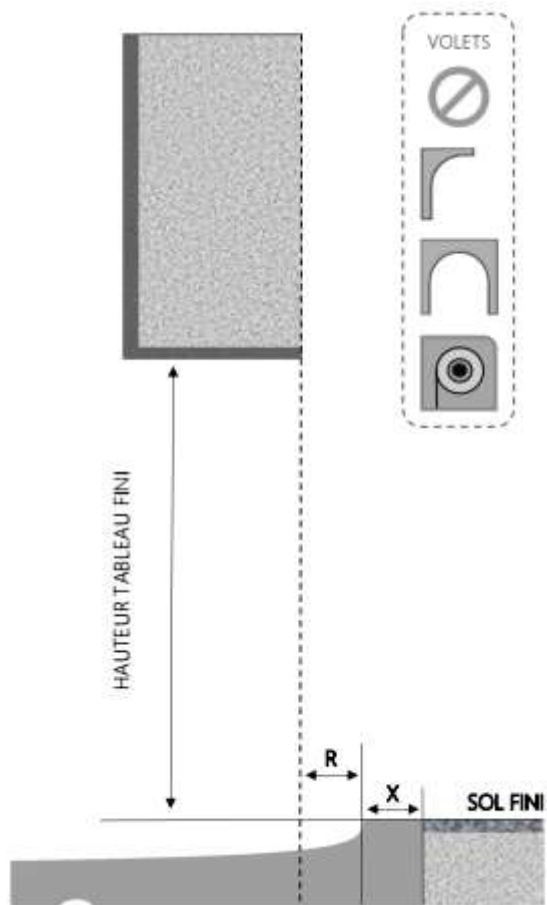

REPERE	TYOLOGIE	ALLEGE	HAUTEUR	LARGEUR

COUPE HORIZONTALE

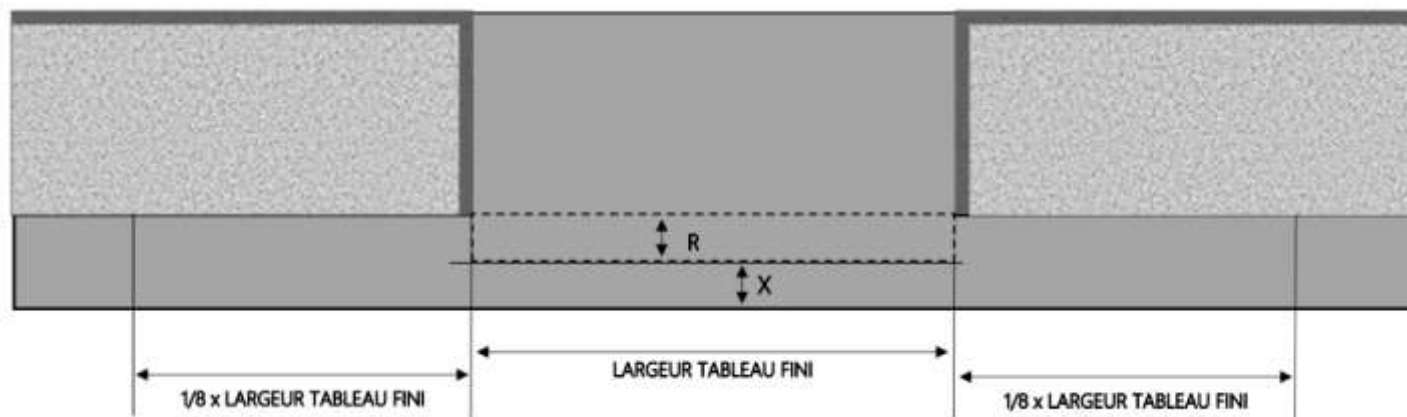

X = SEUIL	191 mm
R = RECUL	50 mm



MENUISERIES POUR BÂTISSEURS

1.3.3.A.4R2C.1F+.290.STD